

The European Union

EDICT OF GOVERNMENT

In order to promote public education and public safety, equal justice for all, a better informed citizenry, the rule of law, world trade and world peace, this legal document is hereby made available on a noncommercial basis, as it is the right of all humans to know and speak the laws that govern them.

EN 1999-1-1 (2007) (English): Eurocode 9: Design of aluminium structures - Part 1-1: General structural rules
[Authority: The European Union Per Regulation 305/2011, Directive 98/34/EC, Directive 2004/18/EC]



BLANK PAGE



English Version

Eurocode 9: Design of aluminium structures - Part 1-1: General structural rules

Eurocode 9: Calcul des structures en aluminium - Partie 1-1: Règles générales

Eurocode 9: Bemessung und Konstruktion von Aluminiumtragwerken - Teil 1-1: Allgemeine Bemessungsregeln

This European Standard was approved by CEN on 18 September 2006.

CEN members are bound to comply with the CEN/CENELEC Internal Regulations which stipulate the conditions for giving this European Standard the status of a national standard without any alteration. Up-to-date lists and bibliographical references concerning such national standards may be obtained on application to the CEN Management Centre or to any CEN member.

This European Standard exists in three official versions (English, French, German). A version in any other language made by translation under the responsibility of a CEN member into its own language and notified to the CEN Management Centre has the same status as the official versions.

CEN members are the national standards bodies of Austria, Belgium, Bulgaria, Cyprus, Czech Republic, Denmark, Estonia, Finland, France, Germany, Greece, Hungary, Iceland, Ireland, Italy, Latvia, Lithuania, Luxembourg, Malta, Netherlands, Norway, Poland, Portugal, Romania, Slovakia, Slovenia, Spain, Sweden, Switzerland and United Kingdom.



EUROPEAN COMMITTEE FOR STANDARDIZATION
COMITÉ EUROPÉEN DE NORMALISATION
EUROPÄISCHES KOMITEE FÜR NORMUNG

Management Centre: rue de Stassart, 36 B-1050 Brussels

Content	Page
Foreword	7
1 General	11
1.1 Scope	11
1.1.1 Scope of EN 1999	11
1.1.2 Scope of EN 1999-1-1	11
1.2 Normative references	12
1.2.1 General references	12
1.2.2 References on structural design	12
1.2.3 References on aluminium alloys	13
1.2.4 References on welding	15
1.2.5 Other references	15
1.3 Assumptions	16
1.4 Distinction between principles and application rules	16
1.5 Terms and definitions	16
1.6 Symbols	17
1.7 Conventions for member axes	27
1.8 Specification for execution of the work	27
2 Basis of design	29
2.1 Requirements	29
2.1.1 Basic requirements	29
2.1.2 Reliability management	29
2.1.3 Design working life, durability and robustness	29
2.2 Principles of limit state design	29
2.3 Basic variables	30
2.3.1 Actions and environmental influences	30
2.3.2 Material and product properties	30
2.4 Verification by the partial factor method	30
2.4.1 Design value of material properties	30
2.4.2 Design value of geometrical data	30
2.4.3 Design resistances	30
2.4.4 Verification of static equilibrium (EQU)	31
2.5 Design assisted by testing	31
3 Materials	32
3.1 General	32
3.2 Structural aluminium	32
3.2.1 Range of materials	32
3.2.2 Material properties for wrought aluminium alloys	33
3.2.3 Material properties for cast aluminium alloys	37
3.2.4 Dimensions, mass and tolerances	37
3.2.5 Design values of material constants	37
3.3 Connecting devices	38
3.3.1 General	38
3.3.2 Bolts, nuts and washers	38
3.3.3 Rivets	39
3.3.4 Welding consumables	40
3.3.5 Adhesives	42
4 Durability	42
5 Structural analysis	43
5.1 Structural modelling for analysis	43
5.1.1 Structural modelling and basic assumptions	43
5.1.2 Joint modelling	43
5.1.3 Ground-structure interaction	43
5.2 Global analysis	43

5.2.1	Effects of deformed geometry of the structure	43
5.2.2	Structural stability of frames	44
5.3	Imperfections	45
5.3.1	Basis	45
5.3.2	Imperfections for global analysis of frames	45
5.3.3	Imperfection for analysis of bracing systems	49
5.3.4	Member imperfections	52
5.4	Methods of analysis	52
5.4.1	General	52
5.4.2	Elastic global analysis	52
5.4.3	Plastic global analysis	52
6	Ultimate limit states for members	53
6.1	Basis	53
6.1.1	General	53
6.1.2	Characteristic value of strength	53
6.1.3	Partial safety factors	53
6.1.4	Classification of cross-sections	53
6.1.5	Local buckling resistance	58
6.1.6	HAZ softening adjacent to welds	59
6.2	Resistance of cross-sections	61
6.2.1	General	61
6.2.2	Section properties	62
6.2.3	Tension	63
6.2.4	Compression	64
6.2.5	Bending moment	64
6.2.6	Shear	66
6.2.7	Torsion	67
6.2.8	Bending and shear	69
6.2.9	Bending and axial force	69
6.2.10	Bending, shear and axial force	71
6.2.11	Web bearing	71
6.3	Buckling resistance of members	71
6.3.1	Members in compression	71
6.3.2	Members in bending	75
6.3.3	Members in bending and axial compression	77
6.4	Uniform built-up members	80
6.4.1	General	80
6.4.2	Laced compression members	82
6.4.3	Battened compression members	83
6.4.4	Closely spaced built-up members	85
6.5	Un-stiffened plates under in-plane loading	85
6.5.1	General	85
6.5.2	Resistance under uniform compression	86
6.5.3	Resistance under in-plane moment	87
6.5.4	Resistance under transverse or longitudinal stress gradient	88
6.5.5	Resistance under shear	88
6.5.6	Resistance under combined action	89
6.6	Stiffened plates under in-plane loading	89
6.6.1	General	89
6.6.2	Stiffened plates under uniform compression	90
6.6.3	Stiffened plates under in-plane moment	92
6.6.4	Longitudinal stress gradient on multi-stiffened plates	92
6.6.5	Multi-stiffened plating in shear	93
6.6.6	Buckling load for orthotropic plates	93
6.7	Plate girders	96
6.7.1	General	96
6.7.2	Resistance of girders under in-plane bending	96
6.7.3	Resistance of girders with longitudinal web stiffeners	97

6.7.4	Resistance to shear.....	98
6.7.5	Resistance to transverse loads	102
6.7.6	Interaction.....	105
6.7.7	Flange induced buckling.....	106
6.7.8	Web stiffeners.....	106
6.8	Members with corrugated webs.....	108
6.8.1	Bending moment resistance.....	108
6.8.2	Shear force resistance	108
7	Serviceability Limit States	110
7.1	General.....	110
7.2	Serviceability limit states for buildings	110
7.2.1	Vertical deflections.....	110
7.2.2	Horizontal deflections.....	110
7.2.3	Dynamic effects	110
7.2.4	Calculation of elastic deflection	110
8	Design of joints.....	111
8.1	Basis of design.....	111
8.1.1	Introduction	111
8.1.2	Applied forces and moments	111
8.1.3	Resistance of joints.....	111
8.1.4	Design assumptions	112
8.1.5	Fabrication and execution.....	112
8.2	Intersections for bolted, riveted and welded joints	112
8.3	Joints loaded in shear subject to impact, vibration and/or load reversal	113
8.4	Classification of joints.....	113
8.5	Connections made with bolts, rivets and pins	113
8.5.1	Positioning of holes for bolts and rivets	113
8.5.2	Deductions for fastener holes	116
8.5.3	Categories of bolted connections.....	117
8.5.4	Distribution of forces between fasteners	119
8.5.5	Design resistances of bolts.....	120
8.5.6	Design resistance of rivets.....	122
8.5.7	Countersunk bolts and rivets	123
8.5.8	Hollow rivets and rivets with mandrel.....	123
8.5.9	High strength bolts in slip-resistant connections	123
8.5.10	Prying forces.....	125
8.5.11	Long joints.....	125
8.5.12	Single lap joints with fasteners in one row	126
8.5.13	Fasteners through packings.....	126
8.5.14	Pin connections.....	126
8.6	Welded connections.....	129
8.6.1	General.....	129
8.6.2	Heat-affected zone (HAZ).....	129
8.6.3	Design of welded connections	129
8.7	Hybrid connections.....	136
8.8	Adhesive bonded connections	136
8.9	Other joining methods	136
	Annex A [normative] – Execution classes.....	137
	Annex B [normative] - Equivalent T-stub in tension.....	140
B.1	General rules for evaluation of resistance.....	140
B.2	Individual bolt-row, bolt-groups and groups of bolt-rows.....	144
	Annex C [informative] - Materials selection	146
C.1	General.....	146
C.2	Wrought products	146
C.2.1	Wrought heat treatable alloys	146

C.2.2	Wrought non-heat treatable alloys.....	149
C.3	Cast products.....	150
C.3.1	General	150
C.3.2	Heat treatable casting alloys EN AC-42100, EN AC-42200, EN AC-43000 and.....	150
	EN AC-43300.....	150
C.3.3	Non-heat treatable casting alloys EN AC-44200 and EN AC-51300.....	150
C.3.4	Special design rules for castings.....	150
C.4	Connecting devices.....	152
C.4.1	Aluminium bolts.....	152
C.4.2	Aluminium rivets.....	152
Annex D [informative] – Corrosion and surface protection.....		153
D.1	Corrosion of aluminium under various exposure conditions.....	153
D.2	Durability ratings of aluminium alloys.....	153
D.3	Corrosion protection.....	154
D.3.1	General	154
D.3.2	Overall corrosion protection of structural aluminium	154
D.3.3	Aluminium in contact with aluminium and other metals	155
D.3.4	Aluminium surfaces in contact with non-metallic materials	155
Annex E [informative] - Analytical models for stress strain relationship.....		160
E.1	Scope.....	160
E.2	Analytical models.....	160
E.2.1	Piecewise linear models	160
E.2.2	Continuous models	162
E.3	Approximate evaluation of ϵ_u	165
Annex F [informative] - Behaviour of cross-sections beyond the elastic limit.....		166
F.1	General	166
F.2	Definition of cross-section limit states.....	166
F.3	Classification of cross-sections according to limit states	166
F.4	Evaluation of ultimate axial load.....	167
F.5	Evaluation of ultimate bending moment	168
Annex G [informative] - Rotation capacity.....		170
Annex H [informative] - Plastic hinge method for continuous beams.....		172
Annex I [informative] - Lateral torsional buckling of beams and torsional or torsional-flexural buckling of compressed members		174
I.1	Elastic critical moment and slenderness.....	174
I.1.1	Basis	174
I.1.2	General formula for beams with uniform cross-sections symmetrical about the minor or major axis	174
I.1.3	Beams with uniform cross-sections symmetrical about major axis, centrally symmetric and doubly symmetric cross-sections.....	179
I.1.4	Cantilevers with uniform cross-sections symmetrical about the minor axis	180
I.2	Slenderness for lateral torsional buckling	182
I.3	Elastic critical axial force for torsional and torsional-flexural buckling	184
I.4	Slenderness for torsional and torsional-flexural buckling.....	185
Annex J [informative] - Properties of cross sections.....		190
J.1	Torsion constant I_t	190
J.2	Position of shear centre S	190
J.3	Warping constant I_w	190
J.4	Cross section constants for open thin-walled cross sections	194
J.5	Cross section constants for open cross section with branches.....	196
J.6	Torsion constant and shear centre of cross section with closed part	196
Annex K [informative] - Shear lag effects in member design.....		197

K.1	General.....	197
K.2	Effective width for elastic shear lag	197
K.2.1	Effective width factor for shear lag	197
K.2.2	Stress distribution for shear lag	198
K.2.3	In-plane load effects	199
K.3	Shear lag at ultimate limit states.....	200
Annex L [informative] - Classification of joints.....		201
L.1	General.....	201
L.2	Fully restoring connections.....	202
L.3	Partially restoring connections	202
L.4	Classification according to rigidity.....	202
L.5	Classification according to strength.....	203
L.6	Classification according to ductility	203
L.7	General design requirements for connections.....	203
L.8	Requirements for framing connections.....	203
L.8.1	General.....	203
L.8.2	Nominally pinned connections	204
L.8.3	Built-in connections.....	205
Annex M [informative] - Adhesive bonded connections		206
M.1	General	206
M.2	Adhesives.....	206
M.3	Design of adhesive bonded joints	207
M.3.1	General	207
M.3.2	Characteristic strength of adhesives.....	207
M.3.3	Design shear stress	208
M.4	Tests	208

Foreword

This European Standard (EN 1999-1-1:2007) has been prepared by Technical Committee CEN/TC250 « Structural Eurocodes », the secretariat of which is held by BSI.

This European Standard shall be given the status of a national standard, either by publication of an identical text or by endorsement, at the latest by November 2007, and conflicting national standards shall be withdrawn at the latest by March 2010.

This European Standard supersedes ENV 1999-1-1: 1998.

According to the CEN/CENELEC Internal Regulations, the national standards organizations of the following countries are bound to implement this European Standard:

Austria, Belgium, Bulgaria, Cyprus, Czech Republic, Denmark, Estonia, Finland, France, Germany, Greece, Hungary, Iceland, Ireland, Italy, Latvia, Lithuania, Luxemburg, Malta, Netherlands, Norway, Poland, Portugal, Romania, Slovakia, Slovenia, Spain, Sweden, Switzerland and the United Kingdom.

Background of the Eurocode programme

In 1975, the Commission of the European Community decided on an action programme in the field of construction, based on article 95 of the Treaty. The objective of the programme was the elimination of technical obstacles to trade and the harmonisation of technical specifications.

Within this action programme, the Commission took the initiative to establish a set of harmonised technical rules for the design of construction works, which in a first stage would serve as an alternative to the national rules in force in the Member States and, ultimately, would replace them.

For fifteen years, the Commission, with the help of a Steering Committee with Representatives of Member States, conducted the development of the Eurocodes programme, which led to the first generation of European codes in the 1980s.

In 1989, the Commission and the Member States of the EU and EFTA decided, on the basis of an agreement¹ between the Commission and CEN, to transfer the preparation and the publication of the Eurocodes to the CEN through a series of Mandates, in order to provide them with a future status of European Standard (EN). This links *de facto* the Eurocodes with the provisions of all the Council's Directives and/or Commission's Decisions dealing with European standards (e.g. the Council Directive 89/106/EEC on construction products – CPD – and Council Directives 93/37/EEC, 92/50/EEC and 89/440/EEC on public works and services and equivalent EFTA Directives initiated in pursuit of setting up the internal market).

The Structural Eurocode programme comprises the following standards generally consisting of a number of Parts:

- EN 1990 Eurocode 0: Basis of structural design
- EN 1991 Eurocode 1: Actions on structures
- EN 1992 Eurocode 2: Design of concrete structures
- EN 1993 Eurocode 3: Design of steel structures
- EN 1994 Eurocode 4: Design of composite steel and concrete structures
- EN 1995 Eurocode 5: Design of timber structures
- EN 1996 Eurocode 6: Design of masonry structures
- EN 1997 Eurocode 7: Geotechnical design
- EN 1998 Eurocode 8: Design of structures for earthquake resistance
- EN 1999 Eurocode 9: Design of aluminium structures

¹ Agreement between the Commission of the European Communities and the European Committee for Standardisation (CEN) concerning the work on EUROCODES for the design of building and civil engineering works (BC/CEN/03/89).

Eurocode standards recognise the responsibility of regulatory authorities in each Member State and have safeguarded their right to determine values related to regulatory safety matters at national level where these continue to vary from State to State.

Status and field of application of Eurocodes

The Member States of the EU and EFTA recognise that Eurocodes serve as reference documents for the following purposes:

- as a means to prove compliance of building and civil engineering works with the essential requirements of Council Directive 89/106/EEC, particularly Essential Requirement N°1 - Mechanical resistance and stability - and Essential Requirement N°2 - Safety in case of fire;
- as a basis for specifying contracts for construction works and related engineering services;
- as a framework for drawing up harmonised technical specifications for construction products (ENs and ETAs)

The Eurocodes, as far as they concern the construction works themselves, have a direct relationship with the Interpretative Documents² referred to in Article 12 of the CPD, although they are of a different nature from harmonised product standard³. Therefore, technical aspects, arising from the Eurocodes work, need to be adequately considered by CEN Technical Committees and/or EOTA Working Groups working on product standards with a view to achieving a full compatibility of these technical specifications with the Eurocodes.

The Eurocode standards provide common structural design rules for everyday use for the design of whole structures and component products of both a traditional and an innovative nature. Unusual forms of construction or design conditions are not specifically covered and additional expert consideration will be required by the designer in such cases.

National Standards implementing Eurocodes

The National Standards implementing Eurocodes will comprise the full text of the Eurocode (including any annexes), as published by CEN, which may be preceded by a National title page and National foreword, and may be followed by a National annex (informative).

The National Annex (informative) may only contain information on those parameters which are left open in the Eurocode for national choice, known as Nationally Determined Parameters, to be used for the design of buildings and civil engineering works to be constructed in the country concerned, i.e. :

- values for partial factors and/or classes where alternatives are given in the Eurocode,
- values to be used where a symbol only is given in the Eurocode,
- geographical and climatic data specific to the Member State, e.g. snow map,
- the procedure to be used where alternative procedures are given in the Eurocode,
- references to non-contradictory complementary information to assist the user to apply the Eurocode.

Links between Eurocodes and product harmonised technical specifications (ENs and ETAs)

There is a need for consistency between the harmonised technical specifications for construction products and the technical rules for works⁴. Furthermore, all the information accompanying the CE Marking of the

² According to Art. 3.3 of the CPD, the essential requirements (ERs) should be given concrete form in interpretative documents for the creation of the necessary links between the essential requirements and the mandates for hENs and ETAGs/ETAs.

³ According to Art. 12 of the CPD the interpretative documents should :

- a) give concrete form to the essential requirements by harmonising the terminology and the technical bases and indicating classes or levels for each requirement where necessary ;
 - b) indicate methods of correlating these classes or levels of requirement with the technical specifications, e.g. methods of calculation and of proof, technical rules for project design, etc. ;
 - c) serve as a reference for the establishment of harmonised standards and guidelines for European technical approvals.
- The Eurocodes, *de facto*, play a similar role in the field of the ER 1 and a part of ER 2.

⁴ See Art.3.3 and Art.12 of the CPD, as well as clauses 4.2, 4.3.1, 4.3.2 and 5.2 of ID 1.

construction products which refer to Eurocodes should clearly mention which Nationally Determined Parameters have been taken into account.

Additional information specific to EN 1999-1-1

EN 1999 is intended to be used with Eurocodes EN 1990 – Basis of Structural Design, EN 1991 – Actions on structures and EN 1992 to EN 1999, where aluminium structures or aluminium components are referred to.

EN 1999-1-1 is the first part of five parts of EN 1999. It gives generic design rules that are intended to be used with the other parts EN 1999-1-2 to EN 1999-1-5.

The four other parts EN 1999-1-2 to EN 1999-1-5 are each addressing specific aluminium components, limit states or type of structures.

EN 1999-1-1 may also be used for design cases not covered by the Eurocodes (other structures, other actions, other materials) serving as a reference document for other CEN TC's concerning structural matters.

EN 1999-1-1 is intended for use by

- committees drafting design related product, testing and execution standards,
- owners of construction works (e.g. for the formulation of their specific requirements)
- designers and constructors
- relevant authorities

Numerical values for partial factors and other reliability parameters are recommended as basic values that provide an acceptable level of reliability. They have been selected assuming that an appropriate level of workmanship and quality management applies.

National annex for EN 1999-1-1

This standard gives alternative procedures, values and recommendations for classes with notes indicating where national choices may have to be made. Therefore the National Standard implementing EN 1999-1-1 should have a National Annex containing all Nationally Determined Parameters to be used for the design of aluminium structures to be constructed in the relevant country.

National choice is allowed in EN 1999-1-1 through clauses:

- 1.1.2(1)
- 2.1.2(3)
- 2.3.1(1)
- 3.2.1(1)
- 3.2.2(1)
- 3.2.2(2)
- 3.2.3.1(1)
- 3.3.2.1(3)
- 3.3.2.2(1)
- 5.2.1(3)
- 5.3.2(3)
- 5.3.4(3)
- 6.1.3(1)
- 6.2.1(5)
- 7.1(4)
- 7.2.1(1)
- 7.2.2(1)
- 7.2.3(1)
- 8.1.1(2)
- 8.9(3)
- A(6) (Table A.1)
- C.3.4.1(2)
- C.3.4.1(3)
- C.3.4.1(4)
- K.1(1)
- K.3(1)

1 General

1.1 Scope

1.1.1 Scope of EN 1999

(1) EN 1999 applies to the design of buildings and civil engineering and structural works in aluminium. It complies with the principles and requirements for the safety and serviceability of structures, the basis of their design and verification that are given in EN 1990 – Basis of structural design.

(2) EN 1999 is only concerned with requirements for resistance, serviceability, durability and fire resistance of aluminium structures. Other requirements, e.g. concerning thermal or sound insulation, are not considered.

(3) EN 1999 is intended to be used in conjunction with:

- EN 1990 “Basis of structural design”
- EN 1991 “Actions on structures”
- European Standards for construction products relevant for aluminium structures
- prEN 1090-1: Execution of steel structures and aluminium structures – Part 1: Requirements for conformity assessment of structural components
- ~~EN 1090-3~~: Execution of steel structures and aluminium structures – Part 3: Technical requirements for aluminium structures

(4) EN 1999 is subdivided in five parts:

EN 1999-1-1 Design of Aluminium Structures: General structural rules.

EN 1999-1-2 Design of Aluminium Structures: Structural fire design.

EN 1999-1-3 Design of Aluminium Structures: Structures susceptible to fatigue.

EN 1999-1-4 Design of Aluminium Structures: Cold-formed structural sheeting.

EN 1999-1-5 Design of Aluminium Structures: Shell structures.

1.1.2 Scope of EN 1999-1-1

(1) EN 1999-1-1 gives basic design rules for structures made of wrought aluminium alloys and limited guidance for cast alloys ~~EN 1999-1-1~~ (see section 3 and Annex C). ~~EN 1999-1-1~~

NOTE Minimum material thickness may be defined in the National Annex. The following limits are recommended – if not otherwise explicitly stated in this standard:

- components with material thickness not less than 0,6 mm;
- welded components with material thickness not less than 1,5 mm;
- connections with:
 - steel bolts and pins with diameter not less than 5 mm;
 - aluminium bolts and pins with diameter not less than 8 mm;
 - rivets and thread forming screws with diameter not less than 4,2 mm

(2) The following subjects are dealt with in EN 1999-1-1:

Section 1: General

Section 2: Basis of design

Section 3: Materials

~~EN 1999-1-1~~ footnote deleted ~~EN 1999-1-1~~

Section 4: Durability

Section 5: Structural analysis

Section 6: Ultimate limit states for members

Section 7: Serviceability limit states

Section 8: Design of joints

Annex A Execution classes

Annex B Equivalent T-stub in tension

Annex C Materials selection

Annex D Corrosion and surface protection

Annex E Analytical models for stress strain relationship

Annex F Behaviour of cross section beyond elastic limit

Annex G Rotation capacity

Annex H Plastic hinge method for continuous beams

Annex I Lateral torsional buckling of beams and torsional or flexural-torsional buckling of compression members

Annex J Properties of cross sections

Annex K Shear lag effects in member design

Annex L Classification of connections

Annex M Adhesive bonded connections

- (3) Sections 1 to 2 provide additional clauses to those given in EN 1990 “Basis of structural design”.
- (4) Section 3 deals with material properties of products made of structural aluminium alloys.
- (5) Section 4 gives general rules for durability.
- (6) Section 5 refers to the structural analysis of structures, in which the members can be modelled with sufficient accuracy as line elements for global analysis.
- (7) Section 6 gives detailed rules for the design of cross sections and members.
- (8) Section 7 gives rules for serviceability.
- (9) Section 8 gives detail rules for connections subject to static loading: bolted, riveted, welded and adhesive bonded connections.

1.2 Normative references

(1) This European Standard incorporates by dated or undated reference, provisions from other publications. These normative references are cited at the appropriate places in the text and the publications are listed hereafter. For dated references, subsequent amendments to or revisions of any of these publications apply to this European Standard only if incorporated in it by amendment or revision. For undated references the latest edition of the publication referred to applies (including amendments).

1.2.1 General references

prEN 1090-1: Execution of steel structures and aluminium structures – Part 1: Requirements for conformity assessment of structural components

~~A1~~ EN 1090-3~~A1~~: Execution of steel structures and aluminium structures – Part 3: Technical requirements for aluminium structures

1.2.2 References on structural design

EN 1990 Basis of structural design

~~A1~~ footnote deleted ~~A1~~

EN 1991 Actions on structures – All parts

A1 Text deleted **A1**

EN 1999-1-2 Design of aluminium structures - Part 1-2: Structural fire design

EN 1999-1-3 Design of aluminium structures - Part 1-3: Structures susceptible to fatigue

EN 1999-1-4 Design of aluminium structures - Part 1-4: Cold-formed structural sheeting

EN 1999-1-5 Design of aluminium structures - Part 1-5: Shell structures

1.2.3 References on aluminium alloys

A1 Text deleted **A1**

A1 1.2.3.1 Technical delivery conditions

EN 485-1 Aluminium and aluminium alloys - Sheet, strip and plate - Part 1: Technical conditions for inspection and delivery

EN 586-1 Aluminium and aluminium alloys - Forgings - Part 1: Technical conditions for inspection and delivery

EN 754-1 Aluminium and aluminium alloys - Cold drawn rod/bar and tube - Part 1: Technical conditions for inspection and delivery

EN 755-1 Aluminium and aluminium alloys - Extruded rod/bar, tube and profiles - Part 1: Technical conditions for inspection and delivery **A1**

A1 Text deleted **A1**

EN 28839 Fasteners - Mechanical properties of fasteners - Bolts, screws, studs and nuts made from non-ferrous metals

EN ISO 898-1 Mechanical properties of fasteners made of carbon steel and alloy steel - Part 1: Bolts, screws and studs

EN ISO 3506-1 Mechanical properties of corrosion-resistant stainless-steel fasteners - Part 1: Bolts, screws and studs

A1 1.2.3.2 Dimensions and mechanical properties

EN 485-2 Aluminium and aluminium alloys - Sheet, strip and plate - Part 2: Mechanical properties

EN 485-3 Aluminium and aluminium alloys - Sheet, strip and plate - Part 3: Tolerances on shape and dimensions for hot-rolled products

EN 485-4 Aluminium and aluminium alloys - Sheet, strip and plate - Part 4: Tolerances on shape and dimensions for cold-rolled products **A1**

EN 508-2	Roofing products from metal sheet - Specifications for self supporting products of steel, aluminium or stainless steel - Part 2: Aluminium
EN 586-2	Aluminium and aluminium alloys - Forgings - Part 2: Mechanical properties and additional property requirements
EN 586-3	Aluminium and aluminium alloys - Forgings - Part 3: Tolerances on dimension and form
EN 754-2	Aluminium and aluminium alloys - Cold drawn rod/bar and tube - Part 2: Mechanical properties
EN 754-3	Aluminium and aluminium alloys - Cold drawn rod/bar and tube - Part 3: Round bars, tolerances on dimension and form
EN 754-4	Aluminium and aluminium alloys - Cold drawn rod/bar and tube - Part 4: Square bars, tolerances on dimension and form
EN 754-5	Aluminium and aluminium alloys - Cold drawn rod/bar and tube - Part 5: Rectangular bars, tolerances on dimension and form
EN 754-6	Aluminium and aluminium alloys - Cold drawn rod/bar and tube - Part 6: Hexagonal bars, tolerances on dimension and form
EN 754-7	Aluminium and aluminium alloys - Cold drawn rod/bar and tube - Part 7: Seamless tubes, tolerances on dimension and form
EN 754-8	Aluminium and aluminium alloys - Cold drawn rod/bar and tube - Part 8: Porthole tubes, tolerances on dimension and form
EN 755-2:2008	Aluminium and aluminium alloys - Extruded rod/bar, tube and profiles - Part 2: Mechanical properties
EN 755-3	Aluminium and aluminium alloys - Extruded rod/bar, tube and profiles- Part 3: Round bars, tolerances on dimension and form
EN 755-4	Aluminium and aluminium alloys - Extruded rod/bar, tube and profiles- Part 4: Square bars, tolerances on dimension and form
EN 755-5	Aluminium and aluminium alloys - Extruded rod/bar, tube and profiles- Part 5: Rectangular bars, tolerances on dimension and form
EN 755-6	Aluminium and aluminium alloys - Extruded rod/bar, tube and profiles- Part 6: Hexagonal bars, tolerances on dimension and form
EN 755-7	Aluminium and aluminium alloys - Extruded rod/bar, tube and profiles- Part 7: Seamless tubes, tolerances on dimension and form
EN 755-8	Aluminium and aluminium alloys - Extruded rod/bar, tube and profiles- Part 8: Porthole tubes, tolerances on dimension and form
EN 755-9	Aluminium and aluminium alloys - Extruded rod/bar, tube and profiles- Part 9: Profiles, tolerances on dimension and form A1

A1 Text deleted **A1**

A1 1.2.3.3 Aluminium alloy castings

EN 1559-1	Founding - Technical conditions of delivery - Part 1: General
EN 1559-4	Founding - Technical conditions of delivery - Part 4: Additional requirements for aluminium alloy castings A1

- EN 1371-1 Founding - Liquid penetrant inspection - Part 1: Sand, gravity die and low pressure die castings
- EN 12681 Founding – Radiographic examination
- EN 571-1 Non destructive testing - Penetrant testing - Part 1: General principles
- EN 13068-1 Non-destructive testing - Radioscopic testing - Part 1: Quantitative measurement of imaging properties
- EN 13068-2 Non-destructive testing - Radioscopic testing - Part 2: Check of long term stability of imaging devices
- EN 13068-3 Non-destructive testing - Radioscopic testing - Part 3: General principles of radioscopic testing of metallic materials by X- and gamma rays
- EN 444 Non-destructive testing - General principles for radiographic examination of metallic materials by X- and gamma-rays
- Text deleted*
- EN 1706 Aluminium and aluminium alloys - Castings - Chemical composition and mechanical properties

1.2.4 References on welding

Text deleted

- EN 1011-4:2000 Welding – Recommendations for welding of metallic materials – Part 4: Arc welding of aluminium and aluminium alloys

Text deleted



1.2.5 Other references

Text deleted

- ISO 8930 General principles on reliability for structures - List of equivalent terms
- ISO 11003-1 Adhesives -- Determination of shear behaviour of structural adhesives -- Part 1: Torsion test method using butt-bonded hollow cylinders
- ISO 11003-2 Adhesives -- Determination of shear behaviour of structural adhesives -- Part 2: Tensile test method using thick adherents
- prEN ISO 1302 Geometrical Product Specification (GPS) - Indication of surface texture in technical product documentation.

EN ISO 4287	Geometrical Product Specifications (GSP) - Surface texture: Profile method - Terms, definitions and surface texture parameters
EN ISO 4288	Geometrical Product Specification (GPS) - Surface texture - Profile method: Rules and procedures for the assessment of surface texture. 

1.3 Assumptions

- (1) In addition to the general assumptions of EN 1990 the following assumptions apply:
- execution complies with  EN 1090-3 

1.4 Distinction between principles and application rules

- (1) The rules in EN 1990 1.4 apply.

1.5 Terms and definitions

- (1) The definitions in EN 1990 1.5 apply.
- (2) The following terms are used in EN 1999-1-1 with the following definitions:

1.5.1

frame

the whole or a portion of a structure, comprising an assembly of directly connected structural members, designed to act together to resist load; this term refers to both moment-resisting frames and triangulated frames; it covers both plane frames and three-dimensional frames

1.5.2

sub-frame

a frame that forms part of a larger frame, but is be treated as an isolated frame in a structural analysis

1.5.3

type of framing

terms used to distinguish between frames that are either:

- **semi-continuous**, in which the structural properties of the members and connections need explicit consideration in the global analysis
- **continuous**, in which only the structural properties of the members need be considered in the global analysis
- **simple**, in which the joints are not required to resist moments

1.5.4

global analysis

the determination of a consistent set of internal forces and moments in a structure, which are in equilibrium with a particular set of actions on the structure

1.5.5

system length

distance in a given plane between two adjacent points at which a member is braced against lateral displacement, or between one such point and the end of the member

1.5.6

buckling length

length of an equivalent uniform member with pinned ends, which has the same cross-section and the same elastic critical force as the verified uniform member (individual or as a component of a frame structure).

1.5.7

shear lag effect

non uniform stress distribution in wide flanges due to shear deformations; it is taken into account by using a reduced “effective” flange width in safety assessments

1.5.8

capacity design

design based on the plastic deformation capacity of a member and its connections providing additional strength in its connections and in other parts connected to the member.

1.6 Symbols

(1) For the purpose of this standard the following apply.

Additional symbols are defined where they first occur.

NOTE Symbols are ordered by appearance in EN 1999-1-1. Symbols may have various meanings.

Section 1 General

x - x	axis along a member
y - y	axis of a cross-section
z - z	axis of a cross-section
u - u	major principal axis (where this does not coincide with the y-y axis)
v - v	minor principal axis (where this does not coincide with the z-z axis)

Section 2 Basis of design

P_k	nominal value of the effect of prestressing imposed during erection
G_k	nominal value of the effect of permanent actions
X_k	characteristic values of material property
X_n	nominal values of material property
R_d	design value of resistance
R_k	characteristic value of resistance
γ_M	general partial factor
γ_{Mi}	particular partial factor
γ_{Mf}	partial factor for fatigue
η	conversion factor
a_d	design value of geometrical data

Section 3 Materials

f_o	characteristic value of 0,2 % proof strength
f_u	characteristic value of ultimate tensile strength
f_{oc}	characteristic value of 0,2 % proof strength of cast material
f_{uc}	characteristic value of ultimate tensile strength of cast material
A_{50}	elongation value measured with a constant reference length of 50 mm, see EN 10 002
$A = A_{5,65\sqrt{A_0}}$	elongation value measured with a reference length $5,65\sqrt{A_0}$, see EN 10 002
A_0	original cross-section area of test specimen
$f_{o,haz}$	0,2 % proof strength in heat affected zone, HAZ
$f_{u,haz}$	ultimate tensile strength in heat affected zone, HAZ
$\rho_{o,haz}$	$= f_{o,haz} / f_o$, ratio between 0,2 % proof strength in HAZ and in parent material
$\rho_{u,haz}$	$= f_{u,haz} / f_u$, ratio between ultimate strength in HAZ and in parent material
BC	buckling class

n_p	exponent in Ramberg-Osgood expression for plastic design
E	modulus of elasticity
G	shear modulus
ν	Poisson's ratio in elastic stage
α	coefficient of linear thermal expansion
ρ	unit mass

Section 5 Structural analysis

α_{cr}	factor by which the design loads would have to be increased to cause elastic instability in a global mode
F_{Ed}	design loading on the structure
F_{cr}	elastic critical buckling load for global instability mode based on initial elastic stiffness
H_{Ed}	design value of the horizontal reaction at the bottom of the storey to the horizontal loads and fictitious horizontal loads
V_{Ed}	total design vertical load on the structure on the bottom of the storey
$\delta_{H,Ed}$	horizontal displacement at the top of the storey, relative to the bottom of the storey
h	storey height, height of the structure
$\bar{\lambda}$	non dimensional slenderness
N_{Ed}	design value of the axial force
ϕ	global initial sway imperfection
ϕ_0	basic value for global initial sway imperfection
α_h	reduction factor for height h applicable to columns
α_m	reduction factor for the number of columns in a row
m	number of columns in a row
e_0	maximum amplitude of a member imperfection
L	member length
$e_{0,d}$	design value of maximum amplitude of an imperfection
M_{Rk}	characteristic moment resistance of the critical cross section
N_{Rk}	characteristic resistance to normal force of the critical cross section
q	equivalent force per unit length
δ_q	in-plane deflection of a bracing system
q_d	equivalent design force per unit length
M_{Ed}	design bending moment
k	factor for $e_{0,d}$

Section 6 Ultimate limit states for members

χ_{M1}	partial factor for resistance of cross-sections whatever the class is
χ_{M1}	partial factor for resistance of members to instability assessed by member checks
χ_{M2}	partial factor for resistance of cross-sections in tension to fracture
b	width of cross section part
t	thickness of a cross-section part
β	width-to-thickness ratio b/t
η	coefficient to allow for stress gradient or reinforcement of cross section part
ψ	stress ratio
σ_{cr}	elastic critical stress for a reinforced cross section part
σ_{cr0}	elastic critical stress for an un-reinforced cross section part
R	radius of curvature to the mid-thickness of material

D	diameter to mid-thickness of tube material
$\beta_1, \beta_2, \beta_3$	limits for slenderness parameter
ε	$= \sqrt{250/f_0}$, coefficient
z_1	distance from neutral axis to most severely stressed fibre
z_2	distance from neutral axis to fibre under consideration
C_1, C_2	Constants
ρ_c	reduction factor for local buckling
b_{haz}	extent of HAZ
T_1	interpass temperature
α_2	factor for b_{haz}

6.2 Resistance of cross sections

$\sigma_{x,\text{Ed}}$	design value of the local longitudinal stress
$\sigma_{y,\text{Ed}}$	design value of the local transverse stress
τ_{Ed}	design value of the local shear stress
N_{Ed}	design normal force
$M_{y,\text{Ed}}$	design bending moment, y-y axis
$M_{z,\text{Ed}}$	design bending moment, z-z axis
N_{Rd}	design values of the resistance to normal forces
$M_{y,\text{Rd}}$	design values of the resistance to bending moments, y-y axis
$M_{z,\text{Rd}}$	design values of the resistance to bending moments, z-z axis
s	staggered pitch, the spacing of the centres of two consecutive holes in the chain measured parallel to the member axis
p	spacing of the centres of the same two holes measured perpendicular to the member axis
n	number of holes extending in any diagonal or zig-zag line progressively across the member or part of the member
d	diameter of hole
A_g	area of gross cross-section
A_{net}	net area of cross-section
A_{eff}	effective area of cross-section
$N_{t,\text{Rd}}$	design values of the resistance to tension force
$N_{o,\text{Rd}}$	design value of resistance to general yielding of a member in tensions
$N_{u,\text{Rd}}$	design value of resistance to axial force of the net cross-section at holes for fasteners
$N_{c,\text{Rd}}$	design resistance to normal forces of the cross-section for uniform compression
M_{Rd}	design resistance for bending about one principal axis of a cross-section
$M_{u,\text{Rd}}$	design resistance for bending of the net cross-section at holes
$M_{o,\text{Rd}}$	design resistance for bending to general yielding
α	shape factor
W_{el}	elastic modulus of the gross section (see 6.2.5.2)
W_{net}	elastic modulus of the net section allowing for holes and HAZ softening, if welded
W_{pl}	plastic modulus of gross section
W_{eff}	effective elastic section modulus, obtained using a reduced thickness t_{eff} for the class 4 parts
$W_{\text{el,haz}}$	effective elastic modulus of the gross section, obtained using a reduced thickness $\rho_{o,\text{haz}}t$ for the HAZ material

$W_{pl,haz}$	effective plastic modulus of the gross section, obtained using a reduced thickness $\rho_{o,haz}t$ for the HAZ material
$W_{eff,haz}$	effective elastic section modulus, obtained using a reduced thickness $\rho_c t$ for the class 4 parts or a reduced thickness $\rho_{o,haz}t$ for the HAZ material, whichever is the smaller
$\alpha_{3,u}$	shape factor for class 3 cross section without welds
$\alpha_{3,w}$	shape factor for class 3 cross section with welds
V_{Ed}	design shear force
V_{Rd}	design shear resistance
A_v	shear area
η_v	factor for shear area
h_w	depth of a web between flanges
t_w	web thickness
A_e	the section area of an un-welded section, and the effective section area obtained by taking a reduced thickness $\rho_{o,haz}t$ for the HAZ material of a welded section
T_{Ed}	design value of torsional moment
T_{Rd}	design St.Venant torsion moment resistance
$W_{T,pl}$	plastic torsion modulus
$T_{t,Ed}$	design value of internal St. Venant torsional moment
$T_{w,Ed}$	design value of internal warping torsional moment
$\tau_{t,Ed}$	design shear stresses due to St. Venant torsion
$\tau_{w,Ed}$	design shear stresses due to warping torsion
$\sigma_{w,Ed}$	design direct stresses due to the bimoment B_{Ed}
B_{Ed}	bimoment
$V_{T,Rd}$	reduced design shear resistance making allowance for the presence of torsional moment
$f_{o,v}$	reduced design value of strength making allowance for the presence of shear force
$M_{v,Rd}$	reduced design value of the resistance to bending moment making allowance for the presence of shear force

6.3 Buckling resistance

N_{Rd}	resistance of axial compression force
$M_{y,Rd}$	bending moment resistance about y-y axis
$M_{z,Rd}$	bending moment resistance about z-z axis
$\eta_0, \gamma_0, \xi_0, \psi$	exponents in interaction formulae
ω_0	factor for section with localized weld
ρ	reduction factor to determine reduced design value of the resistance to bending moment making allowance of the presence of shear force
$N_{b,Rd}$	design buckling resistance of a compression member
κ	factor to allow for the weakening effect of welding
χ	reduction factor for relevant buckling mode
ϕ	value to determine the reduction factor χ
α	imperfection factor
$\bar{\lambda}_0$	limit of the horizontal plateau of the buckling curves
N_{cr}	elastic critical force for the relevant buckling mode based on the gross cross sectional properties
i	radius of gyration about the relevant axis, determined using the properties of the gross cross-section
$\bar{\lambda}$	relative slenderness
$\bar{\lambda}_T$	relative slenderness for torsional or torsional-flexural buckling

N_{cr}	elastic torsional-flexural buckling force
k	buckling length factor
$M_{b,Rd}$	design buckling resistance moment
χ_{LT}	reduction factor for lateral-torsional buckling
ϕ_{LT}	value to determine the reduction factor χ_{LT}
α_{LT}	imperfection factor
$\bar{\lambda}_{LT}$	non dimensional slenderness for lateral torsional buckling
M_{cr}	elastic critical moment for lateral-torsional buckling
$\bar{\lambda}_{0,LT}$	plateau length of the lateral torsional buckling curve
$\eta_c, \gamma_c, \xi_c, \psi_c$	exponents in interaction formulae
$\omega_x, \omega_{x,LT}$	factors for section with localized weld
$\bar{\lambda}_{haz}, \bar{\lambda}_{haz,LT}$	relative slenderness parameters for section with localized weld
x_s	distance from section with localized weld to simple support or point of contra flexure of the deflection curve for elastic buckling from an axial force

6.4 Uniform built-up compression members

L_{ch}	buckling length of chord
h_0	distance of centrelines of chords of a built-up column
a	distance between restraints of chords
α	angle between axes of chord and lacings
i_{min}	minimum radius of gyration of single angles
A_{ch}	area of one chord of a built-up column
$N_{ch,Ed}$	design chord force in the middle of a built-up member
M_{Ed}^1	design value of the maximum moment in the middle of the built-up member
I_{eff}	effective second moment of area of the built-up member
S_v	shear stiffness of built-up member from the lacings or battened panel
n	number of planes of lacings
A_d	area of one diagonal of a built-up column
d	length of a diagonal of a built-up column
A_v	area of one post (or transverse element) of a built-up column
I_{ch}	in plane second moment of area of a chord
I_{bl}	in plane second moment of area of a batten
μ	efficiency factor
i_y, i_z	radius of gyration (y-y axis and z-z axis)

6.5 Un-stiffened plates under in-plane loading

v_1	reduction factor for shear buckling
k_τ	buckling coefficient for shear buckling

6.6 Stiffened plates under in-plane loading

c	elastic support from plate
l_w	half wave-length in elastic buckling
χ	reduction factor for flexural buckling of sub-unit
I_{eff}	second moment of area of effective cross section of plating for in-plane bending
y_{st}	distance from centre of plating to centre of outermost stiffener
B_x	bending stiffness of orthotropic plate in section $x = \text{constant}$

B_y	bending stiffness of orthotropic plate in section $y = \text{constant}$
H	torsional stiffness of orthotropic plate
I_L	second moment of area of one stiffener and adjacent plating in the longitudinal direction
I_{XT}	torsional constant of one stiffener and adjacent plating in the longitudinal direction
a	half distance between stiffeners
t_1, t_2	thickness of layers in orthotropic plate
s	developed width of stiffeners and adjacent plate
$\tau_{cr,g}$	shear buckling stress for orthotropic plate
ϕ, η_h	factors

6.7 Plate girders

b_f	Flange width
h_w	web depth = clear distance between inside flanges
b_w	depth of straight portion of a web
t_w	web thickness
t_f	flange thickness
I_{st}	second moment of area of gross cross-section of stiffener and adjacent effective parts of the web plate
b_1, b_2	distances from stiffener to inside flanges (welds)
a_c	half wave length for elastic buckling of stiffener
ρ_v	factor for shear buckling resistance
η	factor for shear buckling resistance in plastic range
λ_w	slenderness parameter for shear buckling
$V_{w,Rd}$	shear resistance contribution from the web
$V_{f,Rd}$	shear resistance contribution from the flanges
$k_{\tau,st}$	contribution from the longitudinal stiffeners to the buckling coefficient k_τ
$k_{\tau l}$	buckling coefficient for subpanel
c	factor in expression for $V_{f,Rd}$
$M_{f,Rd}$	design moment resistance of a cross section considering the flanges only
A_{f1}, A_{f2}	cross section area of top and bottom flange
F_{Ed}	design transverse force
F_{Rd}	design resistance to transverse force
L_{eff}	effective length for resistance to transverse force
l_y	effective loaded length for resistance to transverse force
χ_F	reduction factor for local buckling due to transverse force
s_s	length stiff bearing under transverse force
λ_F	slenderness parameter for local buckling due to transverse force
k_F	buckling factor for transverse force
γ_s	relative second moment of area of the stiffener closest to the loaded flange
I_{sl}	second moment of area of the stiffener closest to the loaded flange
m_1, m_2	parameters in formulae for effective loaded length
l_e	parameter in formulae for effective loaded length
$M_{N,Rd}$	reduced moment resistance due to presence of axial force
A_w	cross section area of web
A_{fc}	cross-section area of compression flange
k	factor for flange induced buckling

r	radius of curvature
h_f	distance between centres of flanges

6.8 Members with corrugated webs

b_1, b_2	flange widths
t_1, t_2	flange thicknesses
ρ_z	reduction factor due to transverse moments in the flanges
M_z	transverse bending moment in the flanges
$\rho_{c,g}$	reduction factor for global buckling
$\lambda_{c,g}$	slenderness parameter for global buckling
$\tau_{cr,g}$	shear buckling stress for global buckling
$\rho_{c,l}$	reduction factor for local buckling
$\lambda_{c,l}$	slenderness parameter for local buckling
$\tau_{cr,l}$	shear buckling stress for local buckling
$a_0, a_1, a_2, a_3, a_{max}$	widths of corrugations

Section 7 Serviceability limit state

I_{ser}	effective section moment of area for serviceability limit state
I_{eff}	section moment of area for the effective cross-section at the ultimate limit state
σ_{gr}	maximum compressive bending stress at the serviceability limit state based on the gross cross section

Section 8 Design of connections

$\gamma_{M3} \rightarrow \gamma_{M7}$	partial safety factors
γ_{Mw}	partial safety factor for resistance of welded connection
γ_{Mp}	partial safety factor for resistance of pin connection
γ_{Ma}	partial safety factor for resistance of adhesive bonded connection
γ_{Mser}	partial safety factor for serviceability limit state

[A1] Text deleted **[A1]**

$e_1 \rightarrow e_4$,	edge distances
p, p_1, p_2	spacing between bolt holes
d	diameter of fastener
d_0	hole diameter
$V_{eff,1,Rd}$	design block tearing resistance for concentric loading
$V_{eff,2,Rd}$	design block tearing resistance for eccentric loading
A_{nt}	net area subject to tension
A_{nv}	net area subject to shear
A_1	area of part of angle outside the bolt hole
β_2, β_3	reduction factors for connections in angles

$F_{v,Ed}$	design shear force per bolt for the ultimate limit state
$F_{v,Ed,ser}$	design shear force per bolt for the serviceability limit state
$F_{v,Rd}$	design shear resistance per bolt
$F_{b,Rd}$	design bearing resistance per bolt
$F_{s,Rd,ser}$	design slip resistance per bolt at the serviceability limit state
$F_{s,Rd}$	design slip resistance per bolt at the ultimate limit state
$F_{t,Ed}$	design tensile force per bolt for the ultimate limit state
$F_{t,Rd}$	design tension resistance per bolt
$N_{net,Rd}$	design resistance of section at bolt holes
$B_{t,Rd}$	design tension resistance of a bolt-plate assembly
f_{ub}	characteristic ultimate strength of bolt material
f_{ur}	characteristic ultimate strength of rivet material
A_0	cross section area of the hole
A	gross cross section of a bolt
A_s	tensile stress area of a bolt
k_2	factor for tension resistance of a bolt
d_m	mean of the across points and across flats dimensions of the bolt head or the nut or if washers are used the outer diameter of the washer, whichever is smaller;
t_p	thickness of the plate under the bolt head or the nut;
$F_{p,C}$	preloading force
μ	slip factor
n	number of friction interfaces
β_{Lf}	reduction factor for long joint
L_j	distance between the centres of the end fasteners in a long joint
β_p	reduction factor for fasteners passing through packings
a, b	plate thickness in a pin connection
c	gap between plates in a pin connection
f_w	characteristic strength of weld metal
σ_{\perp}	normal stress perpendicular to weld axis
σ_{\parallel}	normal stress parallel to weld axis
τ, τ_{\parallel}	shear stress parallel to weld axis
τ_{\perp}	shear stress perpendicular to weld axis
γ_{Mw}	partial safety factor for welded joints
L_w	total length of longitudinal fillet weld
$L_{w,eff}$	effective length of longitudinal fillet weld
a	effective throat thickness
σ_{haz}	design normal stress in HAZ, perpendicular to the weld axis
τ_{haz}	design shear stress in HAZ
$f_{v,haz}$	characteristic shear strength in HAZ

Annex A Execution classes

U utilization grade

Annex B Equivalent T-stub in tension

$F_{u,Rd}$ tension resistance of a T-stub flange
 B_u tension resistance of a bolt-plate assembly
 B_0 conventional bolt strength at elastic limit

A_s	stress area of bolt
l_{eff}	effective length
e_{min}	minimum edge distance
m	distance from weld toe to centre of bolt

Annex C Materials selection

$\sigma_{\text{eq,Ed}}$	equivalent design stress for castings
$\sigma_{x,\text{Ed}}$	design stress in x-axis direction for castings
$\sigma_{y,\text{Ed}}$	design stress in y-axis direction for castings
$\tau_{xy,\text{Ed}}$	design shear stress for castings
σ_{Rd}	design resistance for castings
$\gamma_{\text{M0,c}}, \gamma_{\text{M1,c}}$	partial factors for yields strength and ultimate strength castings respectively
$\gamma_{\text{M2,co}}, \gamma_{\text{M2,cu}}$	partial factors for yields strength and ultimate strength for bearing resistance of bolts, rivets in castings
$\gamma_{\text{Mp,co}}, \gamma_{\text{Mp,cu}}$	partial factors for yields strength and ultimate strength for bearing resistance of pins in castings

Annex E Analytical model for stress-strain relationship

The symbols are defined in the Annex

Annex F Behavior of cross-sections beyond elastic limit

α_0	geometrical shape factor
α_5, α_{10}	generalized shape factors corresponding to ultimate curvature values $\chi_u = 5\chi_{\text{el}}$ and $\chi_u = 10\chi_{\text{el}}$
$\alpha_{M,\text{red}}$	correction factor for welded class 1 cross section

Annex G Rotation capacity

χ_u	ultimate bending curvature
χ_{el}	elastic bending curvature ($= \chi_{0,2}$)
ξ	ductility factor
M_0	elastic bending moment corresponding to the attainment of the proof stress f_0
m, k	numerical parameters
R	rotation capacity
$\theta_p, \theta_{\text{el}}$	and θ_u , plastic rotation, elastic rotation and maximum plastic rotation corresponding to ultimate curvature χ_u

Annex H Plastic hinge method for continuous beams

η	parameter depending on geometrical shape factor and conventional available ductility of the material
α_ξ	shape factor α_5 or α_{10}
a, b, c	coefficients in expression for η

Annex I Lateral torsional buckling of beams and torsional or flexural-torsional buckling of compression members

I_t	torsion constant
I_w	warping constant
I_z	second moment of area of minor axis
k_z	end condition corresponding to restraints against lateral movement
k_w	end condition corresponding to rotation about the longitudinal axis
k_y	end condition corresponding to restraints against movement in plane of loading

κ_{wt}	non-dimensional torsion parameter
ζ_g	relative non-dimensional coordinate of the point of load application
ζ_j	relative non-dimensional cross section mono-symmetry parameter
μ_{cr}	relative non-dimensional critical moment
z_a	coordinate of the point of load application related to centroid
z_s	coordinate of the shear centre related to centroid
z_g	coordinate of the point of load application related to shear centre
z_j	mono-symmetry constant
c	depth of a lip
ψ_f	mono-symmetry factor
h_f	distance between centrelines of flanges
h_s	distance between shear centre of upper flange and shear centre of bottom flange
I_{fc}	second moment of area of the compression flange about the minor axis of the section
I_{ft}	second moment of area of the tension flange about the minor axis of the section
$C_1, C_2, C_3, C_{1,1}, C_{12}$	coefficients in formulae for relative non-dimensional critical moment
$N_{cr,y}, N_{cr,z}, N_{cr,T}$	elastic flexural buckling load (y-y and z-z axes) and torsional buckling load
i_s	polar radius of gyration
α_{yw}, α_{zw}	coefficients in equation for torsional and torsional-flexural buckling
k, λ_f	coefficients in formula for relative slenderness parameter $\bar{\lambda}_T$
λ_0, s, X	coefficients to calculate λ_f

Annex J Properties of cross sections

β, δ, γ	fillet or bulb factors
b_{sh}	width of flat cross section parts
α	fillet or bulb factor; angle between flat section parts adjacent to fillets or bulbs
D	diameter of circle inscribed in fillet or bulb

NOTE Notations for cross section constants given in J.4 and are not repeated here

Annex K Shear lag effects in member design

b_{eff}	effective width for shear lag
β_s	effective width factor for shear lag
κ	notional width-to-length ratio for flange
A_{st}	area of all longitudinal stiffeners within half the flange width
$a_{st,1}$	relative area of stiffeners = area of stiffeners divided by centre to centre distance of stiffeners
s_e	loaded length in section between flange and web
b_0	width of outstand or half width of internal cross-section part
L_e	points of zero bending moment A1

Annex L Classification of joints

F	load, generalized force force
F_u	ultimate load, ultimate generalized force
v	generalized deformation
v_u	deformation corresponding to ultimate generalized force

Annex M Adhesive bonded connection

$f_{v,adh}$	characteristic shear strength values of adhesives
τ	average shear stress in the adhesive layer
γ_{Ma}	material factor for adhesive bonded joint

1.7 Conventions for member axes

(1) In general the convention for member axes is:

x-x - along the member

y-y - axis of the cross-section

z-z - axis of the cross-section

(2) For aluminium members, the conventions used for cross-section axes are:

- generally:

y-y - cross-section axis parallel to the flanges

z-z - cross-section axis perpendicular to the flanges

- for angle sections:

y-y - axis parallel to the smaller leg

z-z - axis perpendicular to the smaller leg

- where necessary:

u-u - major principal axis (where this does not coincide with the y-y axis)

v-v - minor principal axis (where this does not coincide with the z-z axis)

(3) The symbols used for dimensions and axes of aluminium sections are indicated in Figure 1.1.

(4) The convention used for subscripts, which indicate axes for moments is: "Use the axis about which the moment acts."

NOTE All rules in this Eurocode relate to principal axis properties, which are generally defined by the axes y-y and z-z for symmetrical sections and by the u-u and v-v axis for unsymmetrical section such as angles.

1.8 Specification for execution of the work

(1) A specification for execution of the work should be prepared that contains all necessary technical information to carry out the work. This information should include execution class(es), whether any non-normative tolerances in [EN 1090-3](#) should apply, complete geometrical information and of materials to be used in members and joints, types and sizes of fasteners, weld requirements and requirements for execution of work. [EN 1090-3](#) [A1](#) contains a checklist for information to be provided.

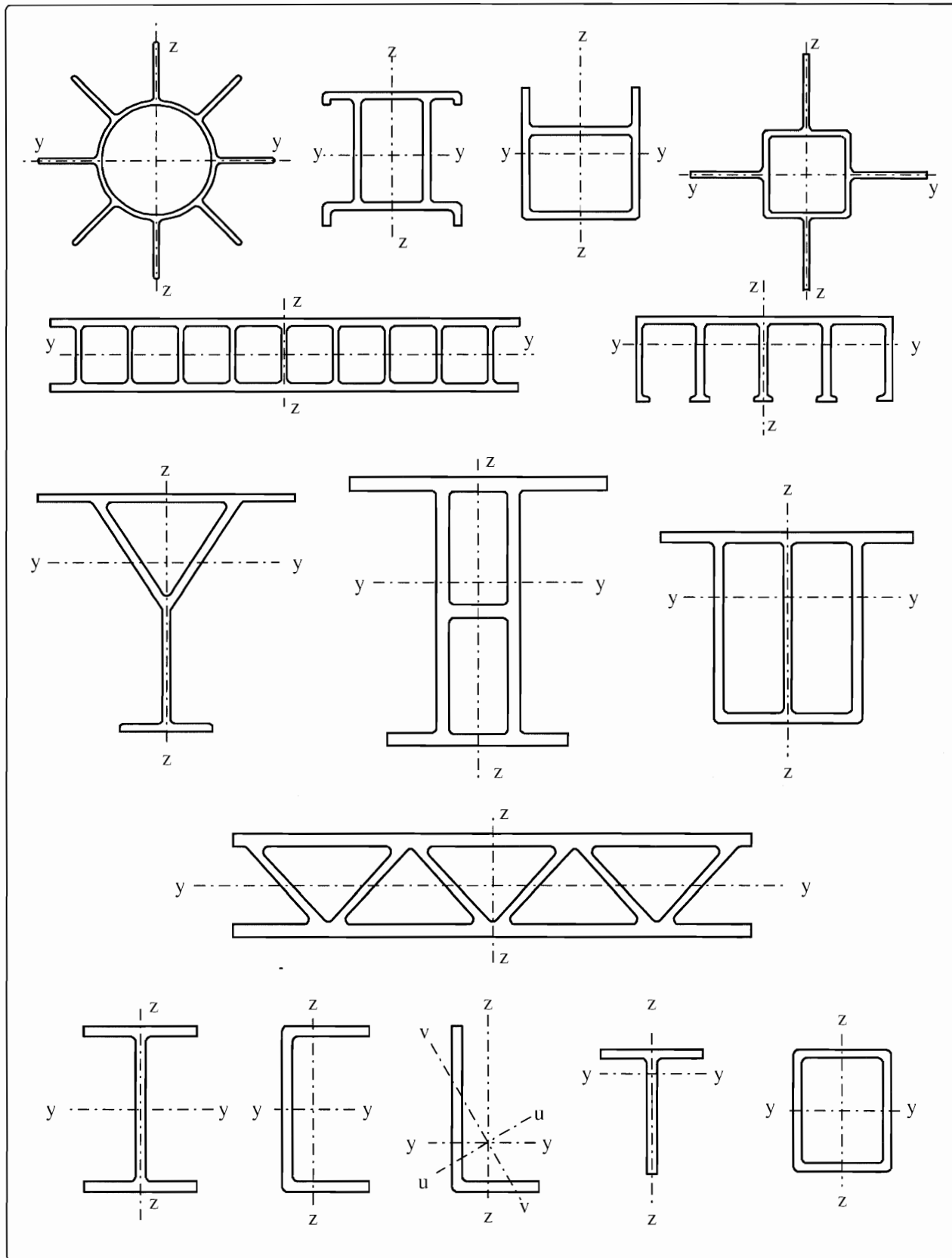

Figure 1.1 - Definition of axes for various cross-sections

2 Basis of design

2.1 Requirements

2.1.1 Basic requirements

- (1)P The design of aluminium structures shall be in accordance with the general rules given in EN 1990.
- (2)P The supplementary provisions for aluminium structures given in this section shall also be applied.
- (3)P The basic requirements of EN 1990 section 2 shall be deemed to be satisfied where limit state design is used in conjunction with the partial factor method and the load combinations given in EN 1990 together with the actions given in EN 1991.
- (4) The rules for resistances, serviceability and durability given in the various parts of EN 1999 should be applied.

2.1.2 Reliability management

- (1) Where different levels of reliability are required, these levels should be achieved by an appropriate choice of quality management in design and execution, according to EN 1990, $\boxed{A_1}$ EN 1090-3 $\boxed{A_1}$.
- (2) Aluminium structures and components are classified in execution classes, see Annex A of this standard.
- (3) The execution should be carried out in accordance with prEN 1090-1 and $\boxed{A_1}$ EN 1090-3. The information, which EN 1090-3 $\boxed{A_1}$ requires to be included in the execution specification, should be provided.

NOTE Options allowed by prEN 1090 may be specified in a National Annex to EN 1999-1-1 to suit the reliability level required.

2.1.3 Design working life, durability and robustness

- (1) Depending on the type of action affecting durability and the design working life (see EN 1990) aluminium structures should as applicable be
- designed for corrosion (see Section 4)
 - designed for sufficient fatigue life (see EN 1999-1-3)
 - designed for wearing
 - designed for accidental actions (see EN 1991-1-7)
 - inspected and maintained.

NOTE 1 Recommendations for the design for corrosion are given in Annex C and Annex D

NOTE 2 Requirements for fatigue, see EN 1999-1-3

2.2 Principles of limit state design

- (1) The resistances of cross sections and members specified in this EN 1999-1-1 for the ultimate limit states as defined in EN 1990 are based on simplified design models of recognised experimental evidence.
- (2) The resistances specified in this EN 1999-1-1 may therefore be used where the conditions for materials in section 3 are met.

2.3 Basic variables

2.3.1 Actions and environmental influences

(1) Actions for the design of aluminium structures should be taken from EN 1991. For the combination of actions and partial factors of actions see Annex A to EN 1990

NOTE The National Annex may define actions for particular regional or climatic or accidental situations.

(2) The actions to be considered in the erection stage should be obtained from EN 1991-1-6.

(3) Where the effects of predicted absolute and differential settlements need be considered best estimates of imposed deformations should be used.

(4) The effects of uneven settlements or imposed deformations or other forms of prestressing imposed during erection should be taken into account by their nominal value P_k as permanent action and grouped with other permanent actions G_k to a single action $(G_k + P_k)$.

(5) Fatigue loading not defined in EN 1991 should be determined according to EN 1999-1-3.

2.3.2 Material and product properties

(1) Material properties for aluminium and other construction products and the geometrical data to be used for design should be those specified in the relevant ENs, ETAGs or ETAs unless otherwise indicated in this standard.

2.4 Verification by the partial factor method

2.4.1 Design value of material properties

(1)P For the design of aluminium structures characteristic value X_k or nominal values X_n of material property shall be used as indicated in this Eurocode.

2.4.2 Design value of geometrical data

(1) Geometrical data for cross sections and systems may be taken from product standards or drawings for the execution according to **EN 1090-3** and treated as nominal values.

(2) Design values of geometrical imperfections specified in this standard comprise

- the effects of geometrical imperfections of members as governed by geometrical tolerances in product standards or the execution standard.
- the effects of structural imperfections from fabrication and erection, residual stresses, variations of the yield strength and heat-affected zones.

2.4.3 Design resistances

(1) For aluminium structures equation (6.6c) or equation (6.6d) of EN 1990 applies:

$$R_d = \frac{1}{\gamma_M} R_k (\eta_1 X_{k1}; \eta_i X_{ki}; a_d) \quad (2.1)$$

where:

R_k is the characteristic value of resistance of a cross section or member determined with characteristic or nominal values for the material properties and cross sectional dimensions

γ_M is the global partial factor for the particular resistance

NOTE For the definition of $\eta_1, \eta_i, X_{k1}, X_{ki}, a_d$ see EN 1990.

2.4.4 Verification of static equilibrium (EQU)

(1) The reliability format for the verification of static equilibrium in Table 1.2 (A) in Annex A of EN 1990 also applies to design situations equivalent to (EQU), e.g. for the design of holding down anchors or the verification of up lift of bearings of continuous beams.

2.5 Design assisted by testing

(1) The resistances R_k in this standard have been determined using Annex D of EN 1990.

(2) In recommending classes of constant partial factors γ_{Mi} the characteristic values R_k were obtained from

$$R_k = R_d \cdot \gamma_{Mi} \quad (2.2)$$

where:

R_d are design values according to Annex D of EN 1990

γ_{Mi} are recommended partial factors.

NOTE 1 The numerical values of the recommended partial factors γ_{Mi} have been determined such that R_k represents approximately the 5 %-fractile for an infinite number of tests.

NOTE 2 For characteristic values of fatigue strength and partial factors γ_{Mf} for fatigue see EN 1999-1-3.

(3) Where resistances R_k for prefabricated products are determined by tests, the procedure referred in (2) should be followed.

3 Materials

3.1 General

(1) The material properties given in this section are specified as characteristic values. They are based on the minimum values given in the relevant product standard.

(2) Other material properties are given in the ENs listed in 1.2.1.

3.2 Structural aluminium

3.2.1 Range of materials

(1) This European standard covers the design of structures fabricated from aluminium alloy material listed in Table 3.1a for wrought alloys conforming to the ENs listed in 1.2.3.1. For the design of structures of cast aluminium alloys given in Table 3.1b, see 3.2.3.1.

NOTE Annex C gives further information for the design of structures of cast aluminium alloys.

Table 3.1a - Wrought aluminium alloys for structures

Alloy designation		Form of product	Durability rating ³⁾
Numerical	Chemical symbols		
EN AW-3004	EN AW-AlMn1Mg1	SH, ST, PL	A
EN AW-3005	EN AW-AlMn1Mg0,5	SH, ST, PL	A
EN AW-3103	EN AW-Al Mn1	SH, ST, PL, ET, EP, ER/B	A
EN AW-5005 / 5005A	EN AW-AlMg1(B) / (C)	SH, ST, PL	A
EN AW-5049	EN AW-AlMg2Mn0,8	SH, ST, PL	A
EN AW-5052	EN AW-Al Mg2,5	SH, ST, PL, ET ²⁾ , EP ²⁾ , ER/B, DT	A
EN AW-5083	EN AW-Al Mg4,5Mn0,7	SH, ST, PL, ET ²⁾ , EP ²⁾ , ER/B, DT, FO	A ¹⁾
EN AW-5454	EN AW-Al Mg3Mn	SH, ST, PL, ET ²⁾ , EP ²⁾ , ER/B	A
EN AW-5754	EN AW-Al Mg3	SH, ST, PL, ET ²⁾ , EP ²⁾ , ER/B, DT, FO	A
EN AW-6060	EN AW-Al MgSi	ET, EP, ER/B, DT	B
EN AW-6061	EN AW-Al Mg1SiCu	SH, ST, PL, ET, EP, ER/B, DT	B
EN AW-6063	EN AW-Al Mg0,7Si	ET, EP, ER/B, DT	B
EN AW-6005A	EN AW-Al SiMg(A)	ET, EP, ER/B	B
EN AW-6082	EN AW-Al Si1MgMn	SH, ST, PL, ET, EP, ER/B, DT, FO	B
EN AW-6106	EN AW-AlMgSiMn	EP	B
EN AW-7020	EN AW-Al Zn4,5Mg1	SH, ST, PL, ET, EP, ER/B, DT	C
EN AW-8011A	EN AW-AlFeSi	SH, ST, PL	B
Key:		ER/B - Extruded Rod and Bar (EN 755)	
SH - Sheet (EN 485)		DT - Drawn Tube (EN 754)	
ST - Strip (EN 485)		FO - Forgings (EN 586)	
PL - Plate (EN 485)		1) See Annex C: C2.2.2(2)	
ET - Extruded Tube (EN 755)		2) Only simple, solid (open) extruded sections or thick-walled tubes over a mandrel (seamless)	
EP - Extruded Profiles (EN 755)		3) See 4, Annex C and Annex D	

Table 3.1b - Cast aluminium alloys for structures

Alloy designation		Durability rating ¹⁾
Numerical	Chemical symbols	
EN AC-42100	EN AC-Al Si7Mg0,3	B
EN AC-42200	EN AC-Al Si7Mg0,6	B
EN AC-43000	EN AC-Al Si10Mg(a)	B
EN AC-43300	EN AC-AlSi9Mg	B
EN AC-44200	EN AC-Al Si12(a)	B
EN AC-51300	EN AC-Al Mg5	A

1) see 4, Annex C and Annex D

NOTE 1 For other aluminium alloys and temper than those listed, see the National Annex.

NOTE 2 For advice on the selection of aluminium alloys see Annex C.

3.2.2 Material properties for wrought aluminium alloys

(1) Characteristic values of the 0,2% proof strength f_0 and the ultimate tensile strength f_u for wrought aluminium alloys for a range of tempers and thicknesses are given in Table 3.2a for sheet, strip and plate products; Table 3.2b for extruded rod/bar, extruded tube and extruded profiles and drawn tube and Table 3.2c for forgings. The values in Table 3.2a, b and c, as well as in Table 3.3 and Table 3.4 (for aluminium fasteners only) are applicable for structures subject to service temperatures up to 80°C.

NOTE Product properties for electrically welded tubes according to EN 1592-1 to 4 for structural applications are not given in this standard. The National Annex may give rules for their application. Buckling class B is recommended.

(2) For service temperatures between 80°C and 100°C reduction of the strength should be taken in account.

NOTE 1 The National Annex may give rules for the reduction of the characteristic values to be applied. For temperatures between 80°C and 100°C the following procedure is recommended:

All characteristic aluminium resistance values ($f_0, f_u, f_{0,haz}$ and $f_{u,haz}$) may be reduced according to

$$X_{kT} = [1 - k_{100}(T - 80) / 20] X_k \quad (3.1)$$

where:

X_k is the characteristic value of a strength property of a material

X_{kT} is the characteristic strength value for the material at temperature T between 80°C and 100 °C

T is the highest temperature the structure is operating

$k_{100} = 0,1$ for strain hardening alloys (3xxx-alloys, 5xxx-alloys and EN AW 8011A)

$k_{100} = 0,2$ for precipitation hardening material (6xxx-alloys and EN AW-7020)

At 100°C generally Buckling Class B is applicable for all aluminium alloys. For temperatures between 80°C and 100°C interpolation between Class A and Class B should be done.

NOTE 2 Between 80°C and 100°C the reduction of the strength values is recoverable, e.g. the materials regain its strength when the temperature is dropping down. For temperatures over 100°C also a reduction of the elastic modulus and additionally time depending, not recoverable reductions of strength should be considered.

(3) Characteristic values for the heat affected zone (0,2% proof strength $f_{0,haz}$ and ultimate tensile strength $f_{u,haz}$) are also given in Table 3.2a to 3.2c and also reduction factors (see 6.1.6), buckling class (used in 6.1.4 and 6.3.1) and exponent in Ramberg-Osgood expression for plastic resistance.

Table 3.2a - Characteristic values of 0,2% proof strength f_0 , ultimate tensile strength f_u (unwelded and for HAZ), min elongation A , reduction factors $\rho_{0,haz}$ and $\rho_{u,haz}$ in HAZ, buckling class and exponent n_p for wrought aluminium alloys - Sheet, strip and plate

Alloy EN- AW	Temper ¹⁾	Thick- ness ¹⁾ mm	f_0 ¹⁾	f_u	A_{50} ^{1) 6)}	$f_{0,haz}$ ²⁾	$f_{u,haz}$ ²⁾	HAZ-factor ²⁾		BC ⁴⁾	n_p 1), 5)
			N/mm ²		%	N/mm ²	N/mm ²	$\rho_{0,haz}$ ¹⁾	$\rho_{u,haz}$		
3004	H14 H24/H34	≤ 6 3	180 170	220	1 3	75	155	0,42 0,44	0,70	B	23 18
	H16 H26/H36	≤ 4 3	200 190	240	1 3			0,38 0,39	0,65	B	25 20
3005	H14 H24	≤ 6 3	150 130	170	1 4	56	115	0,37 0,43	0,68	B	38 18
	H16 H26	≤ 4 3	175 160	195	1 3			0,32 0,35	0,59	B	43 24
3103	H14 H24	≤ 25 12,5	120 110	140	2 4	44	90	0,37 0,40	0,64	B	31 20
	H16 H26	≤ 4	145 135	160	1 2			0,30 0,33	0,56	B	48 28
5005/ 5005A	O/H111	≤ 50	35	100	15	35	100	1	1	B	5
	H12 H22/H32	≤ 12,5	95 80	125	2 4	44	100	0,46 0,55	0,80	B	18 11
	H14 H24/H34	≤ 12,5	120 110	145	2 3			0,37 0,40	0,69	B	25 17
5052	H12 H22/H32	≤ 40	160 130	210	4 5	80	170	0,50 0,62	0,81	B	17 10
	H14 H24/H34	≤ 25	180 150	230	3 4			0,44 0,53	0,74	B	19 11
5049	O / H111	≤ 100	80	190	12	80	190	1	1	B	6
	H14 H24/H34	≤ 25	190 160	240	3 6	100	190	0,53 0,63	0,79	B	20 12
5454	O/H111	≤ 80	85	215	12	85	215	1	1	B	5
	H14 H24/H34	≤ 25	220 200	270	2 4	105	215	0,48 0,53	0,80	B	22 15
5754	O/H111	≤ 100	80	190	12	80	190	1	1	B	6
	H14 H24/H34	≤ 25	190 160	240	3 6	100	190	0,53 0,63	0,79	B	20 12
5083	O/H111	≤ 50	125	275	11	125	275	1	1	B	6
		50 < t ≤ 80	115	270	14 ³⁾	115	270			B	
	H12 H22/H32	≤ 40	250 215	305	3 5	155	275	0,62 0,72	0,90	B	22 14
	H14 H24/H34	≤ 25	280 250	340	2 4			0,55 0,62	0,81	A	22 14
6061	T4 / T451	≤ 12,5	110	205	12	95	150	0,86	0,73	B	8
	T6 / T651	≤ 12,5	240	290	6	115	175	0,48	0,60	A	23
	T651	12,5 < t ≤ 80	240	290	6 ³⁾						
6082	T4 / T451	≤ 12,5	110	205	12	100	160	0,91	0,78	B	8
	T61/T6151	≤ 12,5	205	280	10	125	185	0,61	0,66	A	15
	T6151	12,5 < t ≤ 100	200	275	12 ³⁾			0,63	0,67	A	14
	T6/T651	≤ 6	260	310	6			0,48	0,60	A	25
		6 < t ≤ 12,5	255	300	9			0,49	0,62	A	27
	T651	12,5 < t ≤ 100	240	295	7 ³⁾			0,52	0,63	A	21
7020	T6	≤ 12,5	280	350	7			205	280	0,73	0,80
	T651	≤ 40			9 ³⁾						
8011A	H14 H24	≤ 12,5	110 100	125	2 3	37	85	0,34 0,37	0,68	B	37 22
	H16 H26	≤ 4	130 120	145	1 2			0,28 0,31	0,59		33 33

1) If two (three) tempers are specified in one line, tempers separated by "I" have different technological values but separated by "V" have same values. (The tempers show differences for f_0 , A and n_p).

2) The HAZ-values are valid for MIG welding and thickness up to 15mm. For TIG welding strain hardening alloys (3xxx, 5xxx and 8011A) up to 6 mm the same values apply, but for TIG welding precipitation hardening alloys (6xxx and 7xxx) and thickness up to 6 mm the HAZ values have to be multiplied by a factor 0,8 and so the ρ -factors. For higher thickness – unless other data are available – the HAZ values and ρ -factors have to be further reduced by a factor 0,8 for the precipitation hardening alloys (6xxx and 7xxx) and by a factor 0,9 for the strain hardening alloys (3xxx, 5xxx and 8011A). These reductions do not apply in temper O.

3) Based on A ($= A_{5,65\sqrt{A_0}}$), not A_{50} .

4) BC = buckling class, see 6.1.4.4, 6.1.5 and 6.3.1.

5) n -value in Ramberg-Osgood expression for plastic analysis. It applies only in connection with the listed f_0 -value.

6) The minimum elongation values indicated do not apply across the whole range of thickness given, but mostly to the thinner materials. In detail see EN 485-2.

Table 3.2b - Characteristic values of 0,2% proof strength f_0 and ultimate tensile strength f_u (unwelded and for HAZ), min elongation A , reduction factors $\rho_{0,haz}$ and $\rho_{u,haz}$ in HAZ, buckling class and exponent n_p for wrought aluminium alloys - Extruded profiles, extruded tube, extruded rod/bar and drawn tube

Alloy EN- AW	Product form	Temper	Thick- ness t mm 1) 3)	f_0 1)	f_u 1)	A 5) 2)	$f_{0,haz}$ 4)	$f_{u,haz}$ 4)	HAZ-factor 4)		BC 6)	n_p 7)
				N/mm ²	%	N/mm ²		$\rho_{0,haz}$	$\rho_{u,haz}$			
5083	ET, EP,ER/B	O/H111, F, H112	$t \leq 200$	110	270	12	110	270	1	1	B	5
	DT	H12/22/32	$t \leq 10$	200	280	6	135	270	0,68	0,96	B	14
		H14/24/34	$t \leq 5$	235	300	4			0,57	0,90	A	18
5454	ET, EP,ER/B	O/H111 F/H112	$t \leq 25$	85	200	16	85	200	1	1	B	5
5754	ET, EP,ER/B	O/H111 F/H112	$t \leq 25$	80	180	14	80	180	1	1	B	6
	DT	H14/ H24/H34	$t \leq 10$	180	240	4	100	180	0,56	0,75	B	16
6060	EP,ET,ER/B	T5	$t \leq 5$	120	160	8	50	80	0,42	0,50	B	17
	EP		$5 < t \leq 25$	100	140	8			0,50	0,57	B	14
	ET,EP,ER/B	T6	$t \leq 15$	140	170	8	60	100	0,43	0,59	A	24
	DT		$t \leq 20$	160	215	12			0,38	0,47	A	16
	EP,ET,ER/B	T64	$t \leq 15$	120	180	12	60	100	0,50	0,56	A	12
	EP,ET,ER/B	T66	$t \leq 3$	160	215	8	65	110	0,41	0,51	A	16
	EP		$3 < t \leq 25$	150	195	8			0,43	0,56	A	18
6061	EP,ET,ER/B	T4	$t < 25$	110	180	15	95	150	0,86	0,83	B	8
	DT		$t \leq 20$	110	205	16				0,73	B	8
	EP,ET,ER/B	T6	$t < 25$	240	260	8	115	175	0,48	0,67	A	55
	DT		$t \leq 20$	240	290	10				0,60	A	23
6063	EP,ET,ER/B	T5	$t \leq 3$	130	175	8	60	100	0,46	0,57	B	16
	EP		$3 < t \leq 25$	110	160	7			0,55	0,63	B	13
	EP,ET,ER/B	T6	$t \leq 25$	160	195	8	65	110	0,41	0,56	A	24
	DT		$t \leq 20$	190	220	10			0,34	0,50	A	31
	EP,ET,ER/B	T66	$t \leq 10$	200	245	8	75	130	0,38	0,53	A	22
	EP		$10 < t \leq 25$	180	225	8			0,42	0,58	A	21
	DT		$t \leq 20$	195	230	10			0,38	0,57	A	28
6005A	EP/O, ER/B	T6	$t \leq 5$	225	270	8	115	165	0,51	0,61	A	25
			$5 < t \leq 10$	215	260	8			0,53	0,63	A	24
			$10 < t \leq 25$	200	250	8			0,58	0,66	A	20
	EP/H, ET	T6	$t \leq 5$	215	255	8			0,53	0,65	A	26
			$5 < t \leq 10$	200	250	8			0,58	0,66	A	20
6106	EP	T6	$t \leq 10$	200	250	8	95	160	0,48	0,64	A	20

(A1)

Table 3.2b - Continued

6082	EP,ET,ER/B	T4	$t \leq 25$	110	205	14	100	160	0,91	0,78	B	8
	EP	T5	$t \leq 5$	230	270	8	125	185	0,54	0,69	B	28
	EP ET	T6	$t \leq 5$	250	290	8	125	185	0,50	0,64	A	32
			$5 < t \leq 15$	260	310	10			0,48	0,60	A	25
	ER/B	T6	$t \leq 20$	250	295	8			0,50	0,63	A	27
			$20 < t \leq 150$	260	310	8			0,48	0,60	A	25
DT	T6	$t \leq 5$	255	310	8	0,49			0,60	A	22	
		$5 < t \leq 20$	240	310	10	0,52			0,60	A	17	
7020	EP,ET,ER/B	T6	$t \leq 15$	290	350	10	205	280	0,71	0,80	A	23
	EP,ET,ER/B	T6	$15 < t < 40$	275	350	10			0,75	0,80	A	19
	DT	T6	$t \leq 20$	280	350	10			0,73	0,80	A	18

Key: EP - Extruded profiles EP/O - Extruded open profiles
EP/H - Extruded hollow profiles ET - Extruded tube
ER/B - Extruded rod and bar DT - Drawn tube

1): Where values are quoted in **bold** greater thicknesses and/or higher mechanical properties may be permitted in some forms see ENs and prENs listed in 1.2.1.3. In this case the $R_{p0,2}$ and R_m values can be taken as f_0 and f_u . If using such higher values the corresponding HAZ-factors ρ have to be calculated acc. to expression (6.13) and (6.14) with the same values for $f_{0,haz}$ and $f_{u,haz}$.

2): Where minimum elongation values are given in **bold**, higher minimum values may be given for some forms or thicknesses.

3): According to EN 755-2:2008 following rule applies: "If a profile cross-section is comprised of different thicknesses which fall in more than one set of specified mechanically property values, the lowest specified value should be considered as valid for the whole profile cross-section." Exception is possible and the highest value given may be used provided the manufacturer can support the value by an appropriate quality assurance certificate.

4) The HAZ-values are valid for MIG welding and thickness up to 15mm. For TIG welding strain hardening alloys (3xxx and 5xxx) up to 6 mm the same values apply, but for TIG welding precipitation hardening alloys (6xxx and 7xxx) and thickness up to 6 mm the HAZ values have to be multiplied by a factor 0,8 and so the ρ -factors. For higher thickness – unless other data are available – the HAZ values and ρ -factors have to be further reduced by a factor 0,8 for the precipitation hardening alloys (6xxx and 7xxx) alloys and by a factor 0,9 for strain hardening alloys (3xxx, 5xxx and 8011A). These reductions do not apply in temper O.

$$5) A = A_{5,65\sqrt{A_0}}$$

6) BC = buckling class, see 6.1.4.4, 6.1.5 and 6.3.1.

7) n -value in Ramberg-Osgood expression for plastic analysis. It applies only in connection with the listed f_0 -value (= minimum standardized value).

Text deleted

Table 3.2c - Characteristic values of 0,2% proof strength f_0 , ultimate tensile strength f_u (unwelded and for HAZ), minimum elongation A and buckling class for wrought aluminium alloys - Forgings

Alloy EN-AW	Temper	Thick- ness up to mm	Direction	f_0	f_u	$f_{0,haz}^{1)}$	$f_{u,haz}^{1)}$	$A^{3)}$ %	Buckling class
				N/mm ²					
5754	H112	150	Longitudinal (L)	80	180	80	180	15	B
5083	H112	150	Longitudinal (L)	120	270	120	270	12	B
			Transverse (T)	110	260	110	260	10	B
6082	T6	100	Longitudinal (L)	260	310	125 ²⁾	185 ²⁾	6	A
			Transverse (T)	250	290			5	A

1) $\rho_{0,haz}$; $\rho_{u,haz}$ to be calculated according to expression (6.13) and (6.14)

2) For thicknesses over 15 mm (MIG-welding) or 6 mm (TIG-welding) see table 3.2.b footnote 4).

$$3) A = A_{5,65\sqrt{A_0}}$$

3.2.3 Material properties for cast aluminium alloys

3.2.3.1 General

(1) EN 1999-1-1 is not generally applicable to castings.

NOTE 1 The design rules in this European standard are applicable for gravity cast products according to Table 3.3 if the additional and special rules and the quality provisions of Annex C. C.3.4 are followed.

NOTE 2 The National Annex may give rules for quality requirements for castings.

3.2.3.2 Characteristic values

A1 (1) The characteristic values of the 0,2% proof strength f_0 and the ultimate tensile strength f_u for sand and permanent mould cast aluminium to be met by the caster or the foundry in each location of a cast piece are given in Table 3.3. The listed values are 70% of the values of EN 1706:1998, which are only valid for separately cast test specimens (see 6.3.3.2 of EN 1706:1998).

NOTE The listed values for A_{50} in Table 3.3 are 50 % of the elongation values of EN 1706:1998, which are only valid for separately cast test specimens (see 6.3.3.2 of EN 1706:1998) **A1**

Table 3.3 - Characteristic values of 0,2% proof strength f_0 and ultimate tensile strength f_u for cast aluminium alloys – Gravity castings

Alloy	Casting process	Temper	f_0 (f_{0c}) N/mm ²	f_u (f_{uc}) N/mm ²	A_{50} % ¹⁾
EN AC-42100	Permanent mould	T6	147	203	2,0
	Permanent mould	T64	126	175	4
EN AC-42200	Permanent mould	T6	168	224	1,5
	Permanent mould	T64	147	203	3
EN AC-43000	Permanent mould	F	63	126	1,25
EN AC-43300	Permanent mould	T6	147	203	2,0
	Sand cast	T6	133	161	1,0
	Permanent mould	T64	126	175	3
EN AC-44200	Permanent mould	F	56	119	3
	Sand cast	F	49	105	2,5
EN AC-51300	Permanent mould	F	70	126	2,0
	Sand cast	F	63	112	1,5

1) For elongation requirements for the design of cast components, see C.3.4.2(1).

3.2.4 Dimensions, mass and tolerances

(1) The dimensions and tolerances of structural extruded products, sheet and plate products, drawn tube, wire and forgings, should conform with the ENs and prENs listed in 1.2.3.3.

(2) The dimensions and tolerances of structural cast products should conform with the ENs and prENs listed in 1.2.3.4.

3.2.5 Design values of material constants

(1) The material constants to be adopted in calculations for the aluminium alloys covered by this European Standard should be taken as follows:

- modulus of elasticity $E = 70\,000\text{ N/mm}^2$;
- shear modulus $G = 27\,000\text{ N/mm}^2$;
- Poisson's ratio $\nu = 0,3$;
- coefficient of linear thermal expansion $\alpha = 23 \times 10^{-6}\text{ per }^\circ\text{C}$;
- unit mass $\rho = 2\,700\text{ kg/m}^3$.

(2) For material properties in structures subject to elevated temperatures associated with fire see EN 1999-1-2.

3.3 Connecting devices

3.3.1 General

(1) Connecting devices should be suitable for their specific use.

(2) Suitable connecting devices include bolts, friction grip fasteners, solid rivets, special fasteners, welds and adhesives.

NOTE For adhesives, see Annex M

3.3.2 Bolts, nuts and washers

3.3.2.1 General

(1) Bolts, nuts and washers should conform with existing ENs, prENs and ISO Standards. For load bearing joints bolts and rivets according to Table 3.4 should be used.

(2) The minimum values of the 0,2% proof strength f_o and the ultimate strength f_u to be adopted as characteristic values in calculations, are given in Table 3.4.

(3) Aluminium bolts and rivets should be used only for connections of category A (bearing type, see Table 8.4).

NOTE 1 Presently no EN-standard, which covers all requirements for aluminium bolts, exists. The National Annex may give provisions for the use of aluminium bolts. Recommendations for the use of the bolts listed in Table 3.4 are given in Annex C.

NOTE 2 Presently no EN-standard, which covers all requirements for solid aluminium rivets, exists. Recommendations for the use of the solid rivets listed in Table 3.4 are given in Annex C.

(4) Selftapping and selfdrilling screws and blind rivets may be used for thin-walled structures. Rules are given in EN 1999-1-4.

Table 3.4 - Minimum values of 0,2 % proof strength f_0 and ultimate strength f_u for bolts and solid rivets

Material	Type of fastener	Alloy Numerical designation: EN AW-	Alloy Chemical designation: EN AW-	Temper or grade	Dia-meter	f_0 ⁷⁾ N/mm ²	f_u ⁷⁾ N/mm ²
Aluminium alloy	Solid Rivets ¹⁾	5019	AlMg5	H111	≤20	110	250
				H14,H34	≤18	210	300
		5754	AlMg3	H111	≤20	80	180
				H14/H34	≤18	180	240
		6082	AlSi1MgMn	T4	≤20	110	205
				T6	≤20	240	300
	Bolts ²⁾	5754 (AL1) ³⁾	AlMg3	4)	≤10	230	270
					10<d≤20	180	250
		5019 (AL2) ³⁾	AlMg5	4)	≤14	205	310
					14<d≤36	200	280
		6082 (AL3) ³⁾	AlSi1MgMn	4)	≤6	250	320
					14<d≤36	260	310
Steel	Bolts ⁵⁾			4.6	≤39	240	400
				5.6	≤39	300	500
				6.8	≤39	480	600
				8.8	≤39	640	800
				10.9	≤39	900	1000
Stainless Steel	Bolts ⁶⁾	A2, A4		50	≤39	210	500
		A2, A4		70	≤39	450	700
		A2, A4		80	≤39	600	800

1) see 3.3.2.1 (3) ~~A1~~ text deleted ~~A1~~
2) see 3.3.2.1 (3) ~~A1~~ text deleted ~~A1~~
3) Material designation according to EN 28839
4) No grade designation in EN 28839
5) Grade according to EN ISO 898-1
6) Designation and grade according to EN ISO 3506-1
7) The given values for solid rivets are the lesser values of EN 754 (drawn rods) or EN 1301 (drawn wire) of which solid rivets are manufactured by cold forming. For the 0,2-proof stress EN 1301 defines indeed only typical values, but the above given values can all be regarded as on the safe side. Anyway for the design of connections of category A (bearing mode) the ultimate strength value is the basis for the calculation of the bearing capacity of a bolt or a rivet.

3.3.2.2 Preloaded bolts

(1) Bolts of class 8.8 and 10.9 may be used as preloaded bolts with controlled tightening, provided they conform to the requirements for preloaded bolts in existing ENs, prENs and ISO Standards.

NOTE The National Annex may give rules for bolts not according to these standards, to be used for preloading application.

3.3.3 Rivets

(1) The material properties, dimensions and tolerances of aluminium alloy solid and hollow rivets should conform to ENs, prENs or ISO Standards (if and when they are available).

(2) The minimum guaranteed values of the 0,2% proof strength f_0 and the ultimate strength f_u to be adopted as characteristic values in calculations, are given in Table 3.4.

3.3.4 Welding consumables

(1) All welding consumables should conform to ENs, prENs or ISO Standards (if available) listed in 1.2.2.

NOTE prEN (WI 121 127 and WI 121 214) are in preparation.

(2) The selection of welding filler metal for the combination of alloys being joined should be made from prEN 1011-4 Table B.2 and B.3 in conjunction with the design requirements for the joint, see 8.6.3.1. Guidance on the selection of filler metal for the range of parent metals given in this European Standard is given in Tables 3.5 and 3.6.

Table 3.5 - Alloy grouping used in Table 3.6

Filler metal grouping	Alloys
Type 3	3103
Type 4	4043A, 4047A ¹⁾
Type 5	5056A, 5356 / 5356A, 5556A / 5556B, 5183 / 5183A

¹⁾ 4047A is specifically used to prevent weld metal cracking in joints. In most other cases, 4043A is preferable.

Table 3.6 - Selection of filler metals (see Table 3.5 for alloy types)

Parent metal combination ¹⁾							
1st Part	2nd Part						
	Al-Si castings	Al-Mg castings	3xxx series alloys	5xxx-series alloys except 5083	5083	6xxx-series alloys	7020
7020	NR ²⁾	Type 5 Type 5 Type 5	Type 5 Type 5 Type 4	Type 5 Type 5 Type 5	5556A Type 5 5556A	Type 5 Type 5 Type 4	5556A Type 5 Type 4 ⁴⁾
6xxx-series alloys	Type 4 Type 4 Type 4	Type 5 Type 5 Type 5	Type 4 Type 4 Type 4	Type 5 Type 5 Type 5	Type 5 Type 5 Type 5	Type 5 Type 4 Type 4	
5083	NR ²⁾	Type 5 Type 5 Type 5	Type 5 Type 5 Type 5	Type 5 Type 5 Type 5	5556A Type 5 Type 5		
5xxx-series alloys except 5083	NR ²⁾	Type 5 Type 5 Type 5	Type 5 Type 5 Type 5	Type 5 ³⁾ Type 5			
3xxx series alloys	Type 4 Type 4 Type 4	Type 5 Type 5 Type 5	Type 3 Type 3 Type 3				
Al-Mg castings	NR ²⁾	Type 5 Type 5 Type 5					
Al-Si castings	Type 4 Type 4 Type 4						

¹⁾ In each box the filler metal for the maximum weld strength is shown in the top line; in the case of 6xxx series alloys and EN-AW 7020, this will be below the fully heat treated parent metal strength. The filler metal for maximum resistance to corrosion is shown in the middle line. The filler metal for avoidance of persistent weld cracking is shown on the bottom line.

²⁾ NR = Not recommended. The welding of alloys containing approximately 2% or more of Mg with Al-Si filler metal, or vice-versa is not recommended because sufficient Mg₂Si precipitate is formed at the fusion boundaries to embrittle the weld. Where unavoidable see prEN 1011-4.

³⁾ The corrosion behaviour of weld metal is likely to be better if its alloy content is close to that of the parent metal and not markedly higher. Thus for service in potentially corrosive environments it is preferable to weld EN-AW 5454 with 5454 filler metal. However, in some cases this may only be possible at the expense of weld soundness, so that a compromise will be necessary.

⁴⁾ Only in special cases due to the lower strength of the weld and elongation of the joint.

3.3.5 Adhesives

NOTE Recommendations for adhesive bonded connections are given in Annex M

4 Durability

(1) The basic requirements for durability are given in EN 1990.

NOTE For aluminium in contact with other material, recommendations are given in Annex D.

(2) Under normal atmospheric conditions, aluminium structures made of alloys listed in Tables 3.1a and 3.1.b can be used without the need for surface protection to avoid loss of load-bearing capacity.

NOTE Annex D gives information on corrosion resistance of aluminium and guidelines for surface protection of aluminium, as well as information on conditions for which a corrosion protection is recommended.

(3) Components susceptible to corrosion and subject to aggressive exposure, mechanical wear or fatigue should be designed such that inspection, maintenance and repair can be carried out satisfactorily during the design life. Access should be available for service inspection and maintenance.

(4) The requirements and means for execution of protective treatment undertaken off-site and on-site are given in [EN 1090-3](#).

(5) The execution specification should describe the extent, type and execution procedure for a selected protective treatment.

5 Structural analysis

5.1 Structural modelling for analysis

5.1.1 Structural modelling and basic assumptions

- (1) Analysis should be based upon calculation models of the structure that are appropriate for the limit state under consideration.
- (2) The calculation model and basic assumptions for the calculations should reflect the structural behaviour at the relevant limit state with appropriate accuracy and reflect the anticipated type of behaviour of the cross sections, members, joints and bearings.

5.1.2 Joint modelling

- (1) The effects of the behaviour of the joints on the distribution of internal forces and moments within a structure, and on the overall deformations of the structure, may generally be neglected, but where such effects are significant (such as in the case of semi-continuous joints) they should be taken into account.
- (2) To identify whether the effects of joint behaviour on the analysis need be taken into account, a distinction may be made between three joint models as follows:
- simple, in which the joint may be assumed not to transmit bending moments;
 - continuous, in which the stiffness and/or the resistance of the joint allow full continuity of the members to be assumed in the analysis;
 - semi-continuous, in which the behaviour of the joint needs to be taken into account in the analysis

NOTE Recommendations for the various types of joints are given in Annex L.

5.1.3 Ground-structure interaction

- (1) Account should be taken of the deformation characteristics of the supports where significant.

NOTE EN 1997 gives guidance for calculation of soil-structure interaction.

5.2 Global analysis

5.2.1 Effects of deformed geometry of the structure

- (1) The internal forces and moments may generally be determined using either:
- first-order analysis, using the initial geometry of the structure or
 - second-order analysis, taking into account the influence of the deformation of the structure.
- (2)P The effects of the deformed geometry (second-order effects) shall be considered if they increase the action effects significantly or modify significantly the structural behaviour.
- (3) First order analysis may be used for the structure, if the increase of the relevant internal forces or moments or any other change of structural behaviour caused by deformations can be neglected. This condition may be assumed to be fulfilled, if the following criterion is satisfied:

$$\alpha_{cr} = \frac{F_{cr}}{F_{Ed}} \geq 10 \quad (5.1)$$

where:

α_{cr} is the factor by which the design loading would have to be increased to cause elastic instability in a global mode

F_{Ed} is the design loading on the structure

F_{cr} is the elastic critical buckling load for global instability mode based on initial elastic stiffness.

NOTE The national Annex may give a different criterion for the limit of α_{cr} for neglecting the influence of second order effects.

(4) The effects of shear lag and of local buckling on the stiffness should be taken into account if this significantly influences the global analysis.

NOTE Recommendations how to allow for shear lag are given in Annex K.

(5) The effects on the global analysis of the slip in bolt holes and similar deformations of connection devices like studs and anchor bolts on action effects should be taken into account, where relevant and significant.

5.2.2 Structural stability of frames

(1) If according to 5.2.1 the influence of the deformation of the structure has to be taken into account. (2) to (6) should be applied to consider these effects and to verify the structural stability.

(2) The verification of the stability of frames or their parts should be carried out considering imperfections and second order effects.

(3) According to the type of frame and the global analysis, second order effects and imperfections may be accounted for by one of the following methods:

- a) both totally by the global analysis,
- b) partially by the global analysis and partially through individual stability checks of members according to 6.3,
- c) for basic cases by individual stability checks of equivalent members according to 6.3 using appropriate buckling lengths according to the global buckling mode of the structure.

(4) Second order effects may be calculated by using an analysis appropriate to the structure (including step-by-step or other iterative procedures). For frames where the first sway buckling mode is predominant first order elastic analysis should be carried out with subsequent amplification of relevant action effects (e.g. bending moments) by appropriate factors.

(5) In accordance with 5.2.2(3) a) and b) the stability of individual members should be checked according to the following:

- a) If second order effects in individual members and relevant member imperfections (see 5.3.4) are totally accounted for in the global analysis of the structure, no individual stability check for the members according to 6.3 is necessary.
- b) If second order effects in individual members or certain individual member imperfections (e.g. member imperfections for flexural and/or lateral torsional buckling, see 5.3.4) are not totally accounted for in the global analysis, the individual stability of members should be checked according to the relevant criteria in 6.3 for the effects not included in the global analysis. This verification should take account of end moments and forces from the global analysis of the structure, including global second order effects and global imperfections (see 5.3.2) where relevant and may be based on a buckling length equal to the system length, see Figure 5.1 (d), (e), (f) and (g).

(6) Where the stability of a frame is assessed by a check with the equivalent column method according to 6.3 the buckling length values should be based on a global buckling mode of the frame accounting for the stiffness behaviour of members and joints, the presence of plastic hinges and the distribution of compressive forces under the design loads. In this case internal forces to be used in resistance checks are calculated according to first order theory without considering imperfections, see Figure 5.1 (a), (b) and (c).

5.3 Imperfections

5.3.1 Basis

(1)P Appropriate allowances shall be considered to cover the effects of imperfections, including residual stresses and geometrical imperfections such as lack of verticality, lack of straightness, lack of flatness, lack of fit and any unspecified eccentricities present in joints of the unloaded structure.

NOTE Geometrical imperfections ϕ_0 in accordance with the essential tolerances given in EN 1090-3 are considered in the resistance formulae, the buckling curves and the χ_M -values χ_{M1} in EN 1999.

(2) Equivalent geometric imperfections, see 5.3.2 and 5.3.3, should be used, with values which reflect the possible effects of all type of imperfections. In the equivalent column method according to 5.3.4 the effects are included in the resistance formulae for member design.

(3) The following imperfections should be taken into account:

- a) global imperfections for frames and bracing systems
- b) local imperfections for individual members

5.3.2 Imperfections for global analysis of frames

(1) The assumed shape of global imperfections and local imperfections may be derived from the elastic buckling mode of a structure in the plane of buckling considered.

(2) Both in and out of plane buckling including torsional buckling with symmetric and asymmetric buckling shapes should be taken into account in the most unfavourable direction and form.

(3) For frames sensitive to buckling in a sway mode the effect of imperfections should be allowed for in frame analysis by means of an equivalent imperfection in the form of an initial sway imperfection and individual bow imperfections of members. The imperfections may be determined from:

a) global initial sway imperfections, see Figure 5.1(d):

$$\phi = \phi_0 \alpha_h \alpha_m \quad (5.2)$$

where:

ϕ_0 is the basic value: $\phi_0 = 1/200$

α_h is the reduction factor for height h applicable to columns:

$$\alpha_h = \frac{2}{\sqrt{h}} \quad \text{but} \quad \frac{2}{3} \leq \alpha_h \leq 1,0$$

h is the height of the structure in meters

α_m is the reduction factor for the number of columns in a row: $\alpha_m = \sqrt{0,5 \left(1 + \frac{1}{m} \right)}$

m is the number of columns in a row including only those columns which carry a vertical load N_{Ed} not less than 50% of the average value of the column in the vertical plane considered.

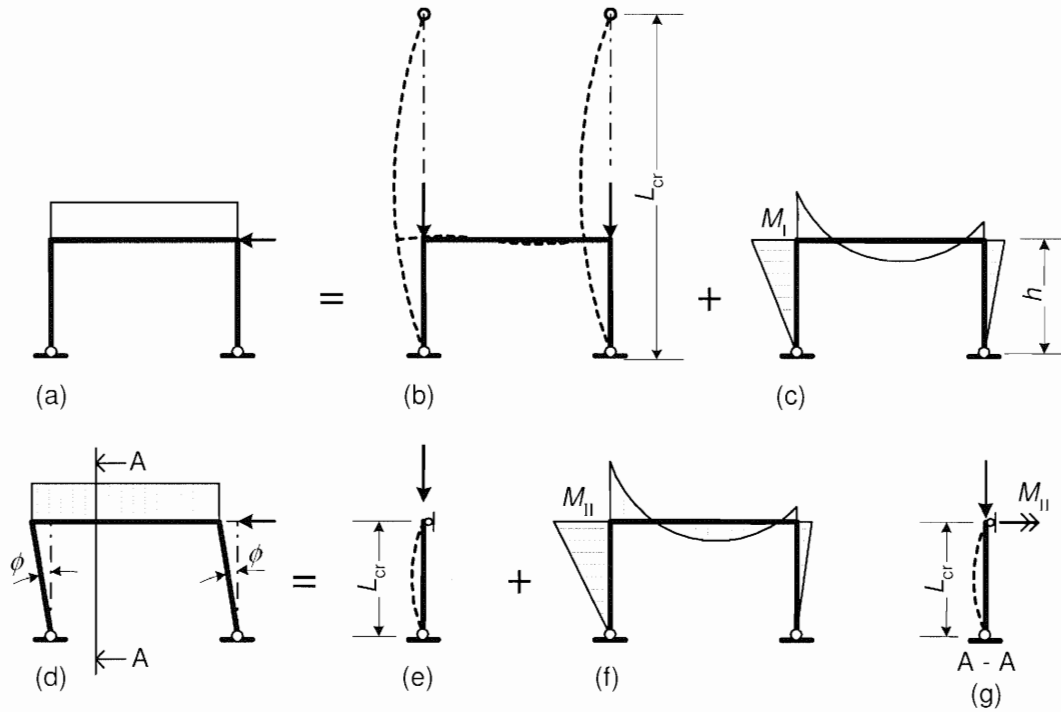

The equivalent column method is illustrated by (a), (b) and (c), where (a) is system and load, (b) is equivalent column length and (c) is the first order moment.

The equivalent sway method is illustrated by (d), (e), (f) and (g), where (d) is system, load and displacement, (e) is initial local bow and buckling length for flexural buckling, (f) is second order moment including moment from sway imperfection and (g) is initial local bow and buckling length for lateral-torsional buckling.

Figure 5.1 - Equivalent buckling length and equivalent sway imperfections

b) relative initial local bow imperfections of members for flexural buckling

$$e_0 / L \tag{5.3}$$

where L is the member length

NOTE The values e_0/L may be chosen in the National Annex. Recommended values are given in Table 5.1.

Table 5.1 - Design values of initial bow imperfection e_0 / L

Buckling class acc. to Table 3.2	elastic analysis	plastic analysis
	e_0/L	e_0/L
A	1/300	1/250
B	1/200	1/150

(4) For building frames sway imperfections may be disregarded where

$$H_{Ed} \geq 0,15 V_{Ed} \tag{5.4}$$

where:

H_{Ed} is the design value of the horizontal force

V_{Ed} is design value of the vertical force.

(5) For the determination of horizontal forces to floor diaphragms the configuration of imperfections as given in Figure 5.2 should be applied, where ϕ is a sway imperfection obtained from expression (5.2) assuming a single storey with height h , see (3) a).

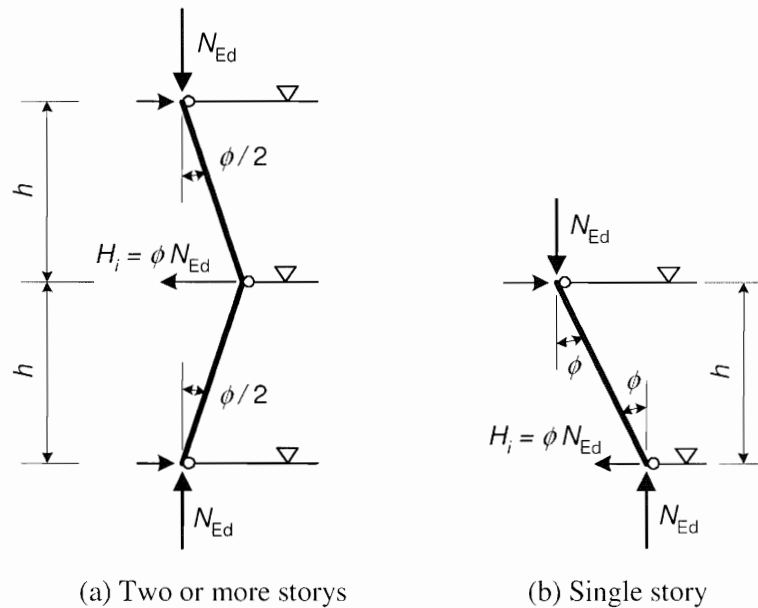

Figure 5.2 - Configuration of sway imperfections ϕ for horizontal forces on floor diaphragms

(6) When performing the global analysis for determining end forces and end moments to be used in member checks according to 6.3 local bow imperfections may be neglected. However, for frames sensitive to second order effects local bow imperfections of members additionally to global sway imperfections (see 5.2.1(3)) should be introduced in the structural analysis of the frame for each compressed member where the following conditions are met:

- at least one moment resistant joint at one member end

- $$\bar{\lambda} > 0,5 \sqrt{\frac{A f_o}{N_{Ed}}} \quad (5.5)$$

where:

N_{Ed} is the design value of the compression force

$\bar{\lambda}$ is the in-plane relative slenderness calculated for the member considered as hinged at its ends

NOTE Local bow imperfections are taken into account in member checks, see 5.2.2 (3) and 5.3.4.

(7) The effects of initial sway imperfection and bow imperfections may be replaced by systems of equivalent horizontal forces, introduced for each column, see Figure 5.2 and Figure 5.3.

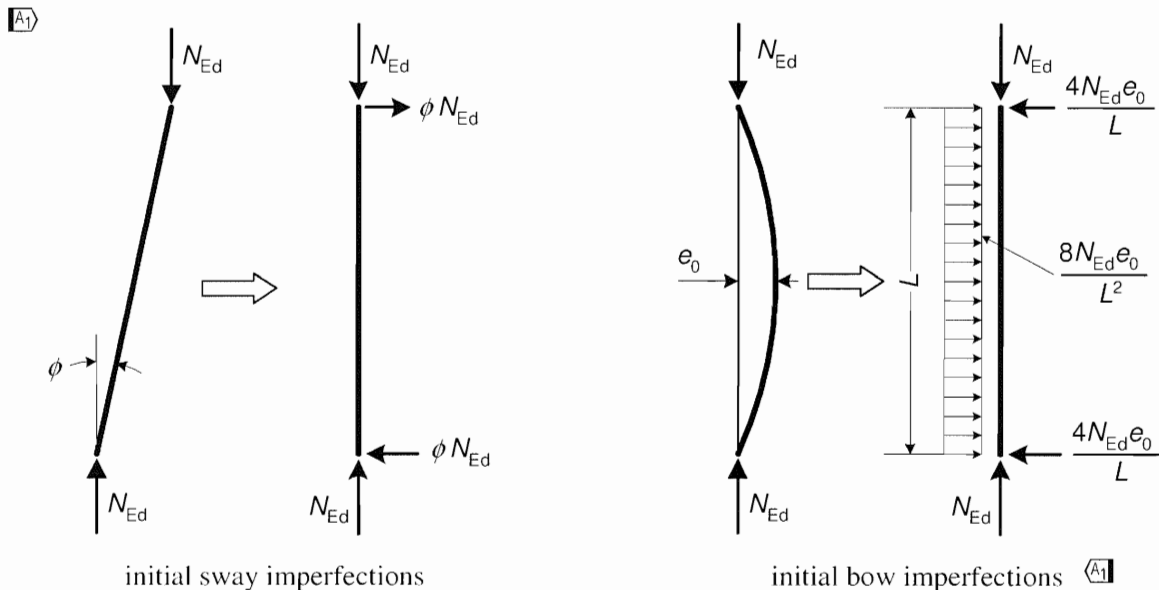

Figure 5.3 - Replacement of initial imperfections by equivalent horizontal forces

- (8) These initial sway imperfections should apply in all relevant horizontal directions, but need only be considered in one direction at a time.
- (9) Where, in multi-storey beam-and-column building frames, equivalent forces are used they should be applied at each floor and roof level.
- (10) The possible torsional effects on a structure caused by anti-symmetric sways at the two opposite faces, should also be considered, see Figure 5.4.

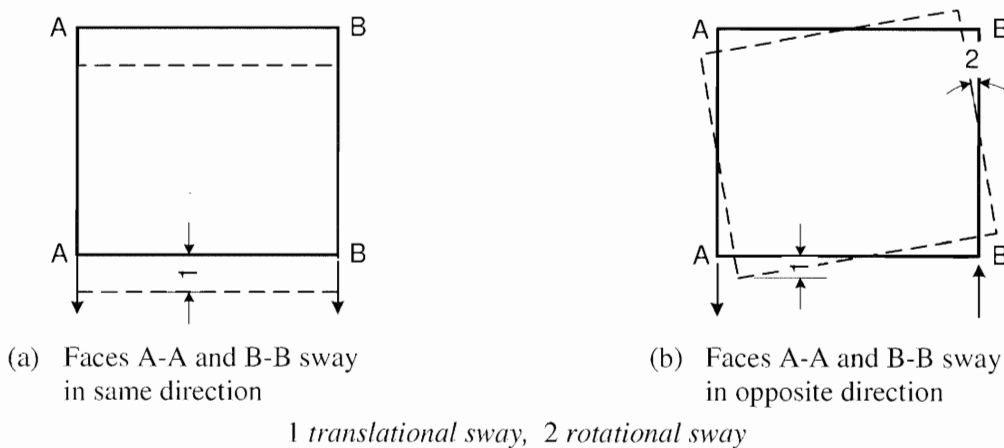

Figure 5.4 - Translational and torsional effects (plan view)

(11) As an alternative to (3) and (6) the shape of the elastic critical buckling mode η_{cr} of the structure or of the verified member may be applied as a unique global and local imperfection. The equivalent geometrical imperfection may be expressed in the form:

$$A1 \quad \eta_{init}(x) = e_0 \frac{N_{cr,m}}{EI_m |\eta''_{cr,m}|} \eta_{cr}(x) \tag{5.6} A1$$

where:

$$A1 \quad e_0 = \alpha (\bar{\lambda}_m - \bar{\lambda}_0) \frac{M_{Rk,m}}{N_{Rk,m}} \frac{1 - \chi \bar{\lambda}_m^2}{1 - \chi \bar{\lambda}_m^2} \frac{\gamma_{M1}}{\gamma_{M1}} \quad \text{for } \bar{\lambda}_m > \bar{\lambda}_0 \tag{5.7} A1$$

\square_{A1} and m denotes the cross-section where $|\eta_{cr}''|$ reaches its maximum in the case of uniform normal force and uniform cross-section; \square_{A1}

α is the imperfection factor for the relevant buckling curve, see Table 6.6;

$\bar{\lambda}_m = \sqrt{\frac{N_{Rk,m}}{N_{cr,m}}}$ is the relative slenderness of the structure;

$\bar{\lambda}_0$ is the limit given in Table 6.6;

χ is the reduction factor for the relevant buckling curve, see 6.3.1.2;

$N_{cr,m} = \alpha_{cr} N_{Ed,m}$ is the value of axial force in cross-section m when the elastic critical buckling was reached;

α_{cr} is the minimum force amplifier for the axial force configuration N_{Ed} in members to reach the elastic critical buckling;

$M_{Rk,m}$ is the characteristic moment resistance of the cross-section m according to (6.25) 6.2.5.1;

$N_{Rk,m}$ is the characteristic normal force resistance of the cross-section m according to (6.22) 6.2.4;

\square_{A1} $EI_m |\eta_{cr,m}''|$ is the bending moment due to η_{cr} at the cross-section m ; \square_{A1}

η_{cr}'' is the second derivative of $\eta_{cr}(x)$

NOTE 1 For calculating the amplifier α_{cr} the members of the structure may be considered to be loaded by axial forces N_{Ed} only that result from the first order elastic analysis of the structure for the design loads.

NOTE 2 The ratio \square_{A1} $\frac{1}{EI_m |\eta_{cr,m}''|}$ may be replaced by $\frac{|\eta^{II}|_{\max}}{|M_{\eta_{cr,m}^{II}}| |\eta_{cr}|_{\max}}$ \square_{A1}

where:

\square_{A1} $|\eta_{cr}|_{\max}$ is the maximum value of the amplitude of the buckling mode of the structure (arbitrary value may be taken); \square_{A1}

\square_{A1} $|\eta^{II}|_{\max}$ is the maximum deflection of the structure calculated using second order analysis (symbolised by II) for the structure with the imperfection in the shape of the elastic critical buckling mode η_{cr} with maximum amplitude $|\eta_{cr}|_{\max}$; \square_{A1}

$M_{\eta_{cr,m}^{II}}$ is the bending moment in cross-section m calculated as given for $|\eta^{II}|_{\max}$.

The bending moments in the structure due to $\eta_{init}(x)$ with allowing for second order effects may be then calculated from:

$$\square_{A1} M_{\eta_{init}^{II}}(x) = \frac{e_0 N_{cr,m} |\eta^{II}|_{\max}}{|M_{\eta_{cr,m}^{II}}| |\eta_{cr}|_{\max}} M_{\eta_{cr}^{II}}(x) \quad (5.8) \quad \square_{A1}$$

NOTE 3 Formula (5.6) is based on the requirement that the imperfection η_{init} having the shape of the elastic buckling mode η_{cr} , should have the same maximum curvature as the equivalent uniform member.

5.3.3 Imperfection for analysis of bracing systems

(1) In the analysis of bracing systems which are required to provide lateral stability within the length of beams or compression members the effects of imperfections should be included by means of an equivalent geometric imperfection of the members to be restrained, in the form of an initial bow imperfection:

$$e_0 = \alpha_m L / 500 \quad (5.9)$$

where:

L is the span of the member and

$$\alpha_m = \sqrt{0,5 \left(1 + \frac{1}{m} \right)} \quad (5.10)$$

in which m is the number of members to be restrained.

(2) For convenience, the effects of the initial bow imperfections of the members to be restrained by a bracing system, may be replaced by the equivalent stabilising force as shown in Figure 5.5:

$$q_0 = \sum N_{Ed} \delta \frac{e_0 + \delta_q}{L^2} \quad (5.11)$$

where:

δ_q is the inplane deflection of the bracing system due to q_0 plus any external loads calculated from first order analysis.

NOTE 1 δ_q may be taken as 0 if second order theory is used.

NOTE 2 As δ_q in (5.11) depends on q_0 , it results in an iterative procedure.

(3) Where the bracing system is required to stabilise the compression flange of a beam of constant height, the force N_{Ed} in Figure 5.5 may be obtained from:

$$N_{Ed} = M_{Ed} / h \quad (5.12)$$

where:

M_{Ed} is the maximum moment in the beam

h is the overall depth of the beam.

NOTE Where a beam is subjected to external compression, this should be taken into account.

(4) At points where beams or compression members are spliced, it should also be verified that the bracing system is able to resist a local force equal to $\alpha_m N_{Ed} / 100$ applied to it by each beam or compression member which is spliced at that point, and to transmit this force to the adjacent points at which that beam or compression member is restrained, see Figure 5.6.

(5) For checking for the local force according to clause (4), any external loads acting on bracing systems should also be included, but the forces arising from the imperfection given in (1) may be omitted.

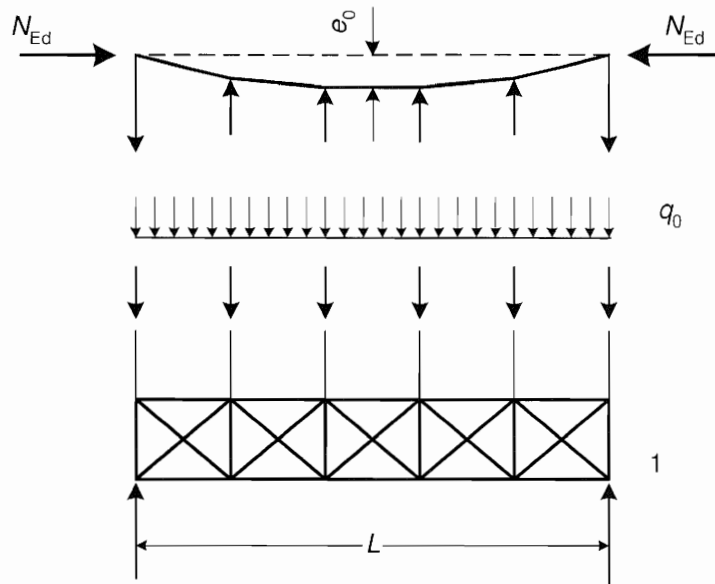

- e_0 imperfection
- q_0 equivalent force per unit length
- 1 bracing system

The force N_{Ed} is assumed uniform within the span L of the bracing system. For non-uniform forces this is slightly conservative.

Figure 5.5 - Equivalent stabilising force

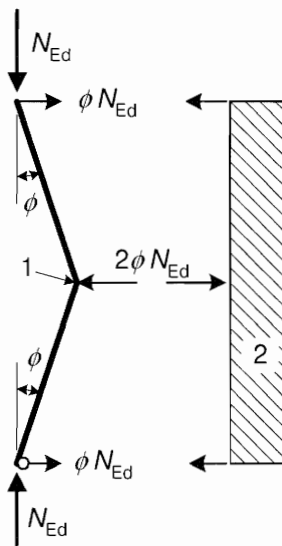

$$\phi = \alpha_m \phi_0 \quad : \phi_0 = 1/200$$

$$2\phi N_{Ed} = \alpha_m N_{Ed} / 100$$

1 splice, 2 bracing system

Figure 5.6 - Bracing forces at splices in compression members

5.3.4 Member imperfections

(1) The effects of imperfections of members described in 5.3.1(1) are incorporated within the formulas given for buckling resistance for members, see section 6.3.1.

(2) Where the stability of members is accounted for by second order analysis according to 5.2.2(5)a) for compression members imperfections $\overline{A_1} e_0 \overline{A_1}$ according to 5.3.2(3)b) or 5.3.2(5) or (6) should be considered.

(3) For a second order analysis taking account of lateral torsional buckling of a member in bending the imperfections may be adopted as $\overline{A_1} k e_0 \overline{A_1}$, where $e_0 \overline{A_1}$ is the equivalent initial bow imperfection of the weak axis of the profile considered. In general an additional torsional imperfection need not to be allowed for.

NOTE The National Annex may choose the value of k . The value $k = 0,5$ is recommended.

5.4 Methods of analysis

5.4.1 General

(1) The internal forces and moments may be determined using either

- a) elastic global analysis
- b) plastic global analysis.

NOTE For finite element model (FEM) analysis see EN 1993-1-5.

(2) Elastic global analysis may be used in all cases.

(3) Plastic global analysis may be used only where the structure has sufficient rotation capacity at the actual location of the plastic hinge, whether this is in the members or in the joints. Where a plastic hinge occurs in a member, the member cross sections should be double symmetric or single symmetric with a plane of symmetry in the same plane as the rotation of the plastic hinge and it should satisfy the requirements specified in 5.4.3. Where a plastic hinge occurs in a joint the joint should either have sufficient strength to ensure the hinge remains in the member or should be able to sustain the plastic resistance for a sufficient rotation.

NOTE 1 Information on rotation capacity is given in Annex G.

NOTE 2 Only certain alloys have the required ductility to allow sufficient rotation capacity, see 6.4.3(2).

5.4.2 Elastic global analysis

(1) Elastic global analysis is based on the assumption that the stress-strain behaviour of the material is linear, whatever the stress level is.

NOTE For the choice of a semi-continuous joint model see 5.1.2.

(2) Internal forces and moments may be calculated according to elastic global analysis even if the resistance of a cross section is based on its plastic resistance.

(3) Elastic global analysis may also be used for cross sections, the resistances of which are limited by local buckling.

5.4.3 Plastic global analysis

(1) Plastic global analysis should not be used for beams with transverse welds on the tension side of the member at the plastic hinge locations.

NOTE For plastic global analysis of beams recommendations are given in Annex H.

(2) Plastic global analysis should only be used where the stability of members can be assured, see 6.3.

6 Ultimate limit states for members

6.1 Basis

6.1.1 General

(1)P Aluminium structures and components shall be proportioned so that the basic design requirements for the ultimate limit state given in Section 2 are satisfied. The design recommendations are for structures subjected to normal atmospheric conditions.

6.1.2 Characteristic value of strength

(1) Resistance calculations for members are made using characteristic value of strength as follows:

f_o is the characteristic value of the strength for bending and overall yielding in tension and compression

f_u is the characteristic value of the strength for the local capacity of a net section in tension or compression

(2) The characteristic value of the 0,2% proof strength f_o and the ultimate tensile strength f_u for wrought aluminium alloys are given in 3.2.2.

6.1.3 Partial safety factors

(1) The partial factors γ_M as defined in 2.4.3 should be applied to the various characteristic values of resistance in this section as follows:

Table 6.1 - Partial safety factors for ultimate limit states

resistance of cross-sections whatever the class is:	γ_{M1}
resistance of members to instability assessed by member checks:	
resistance of cross-sections in tension to fracture:	γ_{M2}
resistance of joints:	See Section 8

NOTE 1 Partial factors γ_{Mi} may be defined in the National Annex. The following numerical values are recommended:

$$\gamma_{M1} = 1,10$$

$$\gamma_{M2} = 1,25$$

NOTE 2 For other recommended numerical values see EN 1999 Part 1-2 to Part 1-5. For structures not covered by EN 1999 Part 1-2 to Part 1-5 the National Annex may give information.

6.1.4 Classification of cross-sections

6.1.4.1 Basis

(1) The role of cross-section classification is to identify the extent to which the resistance and rotation capacity of cross-sections is limited by its local buckling resistance.

NOTE See also Annex F.

6.1.4.2 Classification

(1) Four classes of cross-sections are defined, as follows:

- Class 1 cross-sections are those that can form a plastic hinge with the rotation capacity required for plastic analysis without reduction of the resistance.

NOTE Further information on class 1 cross-sections is given in Annex G.

- Class 2 cross-sections are those that can develop their plastic moment resistance, but have limited rotation capacity because of local buckling.

- Class 3 cross-sections are those in which the calculated stress in the extreme compression fibre of the aluminium member can reach its proof strength, but local buckling is liable to prevent development of the full plastic moment resistance.
- Class 4 cross-sections are those in which local buckling will occur before the attainment of proof stress in one or more parts of the cross-section.

(2) In Class 4 cross-sections effective thickness may be used to make the necessary allowances for reduction in resistance due to the effects of local buckling, see 6.1.5.

(3) The classification of a cross-section depends on the width to thickness ratio of the parts subject to compression.

(4) Compression parts include every part of a cross-section that is either totally or partially in compression under the load combination considered.

(5) The various compression parts in a cross-section (such as web or a flange) can, in general, be in different classes. A cross-section is classified according to the highest (least favourable) class of its compression parts.

(6) The following basic types of thin-walled part are identified in the classification process:

- a) flat outstand parts;
- b) flat internal parts;
- c) curved internal parts.

These parts can be un-reinforced, or reinforced by longitudinal stiffening ribs or edge lips or bulbs (see Figure 6.1).

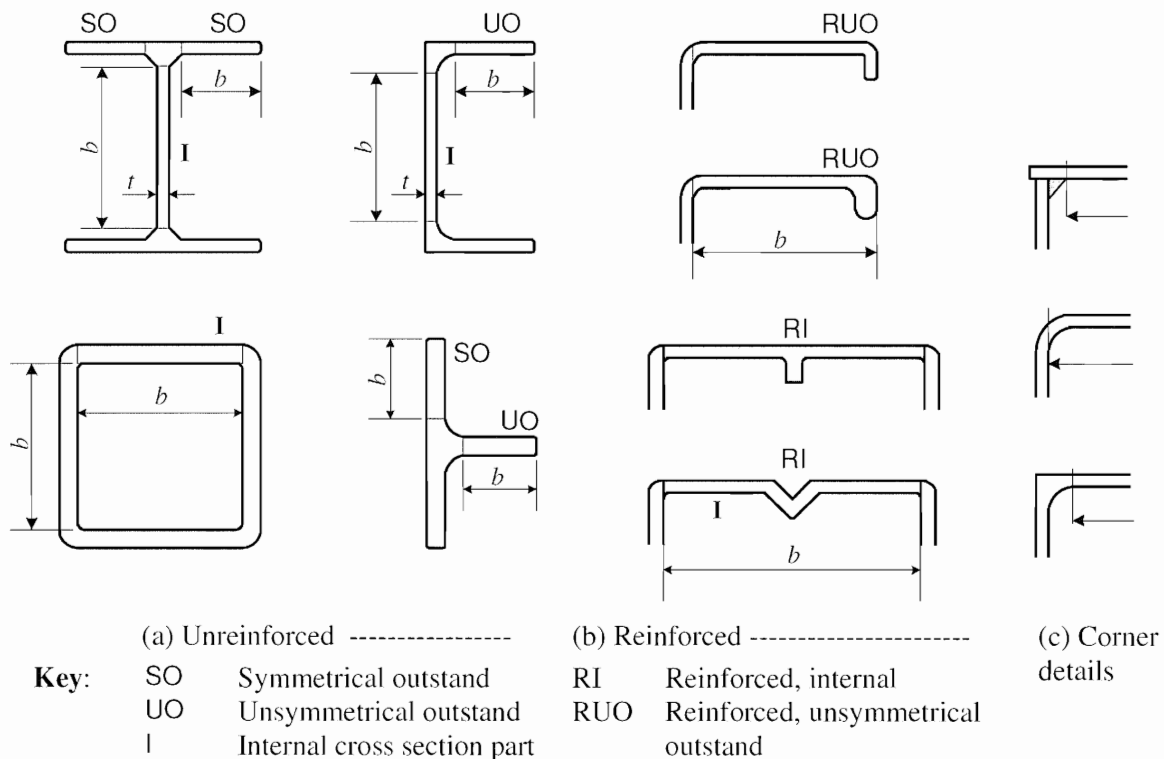

Figure 6.1 - Types of cross-section parts

6.1.4.3 Slenderness parameters

(1) The susceptibility of an un-reinforced flat part to local buckling is defined by the parameter β , which has the following values:

a) flat internal parts with no stress gradient or flat outstands with no stress gradient or peak compression at toe $\beta = b/t$ (6.1)

b) internal parts with a stress gradient that results in a neutral axis at the \bar{A}_1 centre \bar{A}_1 $\beta = 0,40 b/t$ (6.2)

c) internal parts with stress gradient and outstands with peak compression at root $\beta = \eta b/t$ (6.3)

where:

b is the width of a cross-section part

t is the thickness of a cross-section

η is the stress gradient factor given by the expressions:

$$\eta = 0,70 + 0,30\psi \quad (1 \geq \psi \geq -1), \quad (6.4)$$

$$\eta = 0,80 / (1 - \psi) \quad (\psi < -1), \text{ see Figure 6.2} \quad (6.5)$$

where

ψ is the ratio of the stresses at the edges of the plate under consideration related to the maximum compressive stress. In general the neutral axis should be the elastic neutral axis, but in checking whether a section is class 1 or 2 it is permissible to use the plastic neutral axis.

NOTE All cross section parts are considered simply supported when calculating the parameters β even if the cross section parts are elastically restrained or clamped.

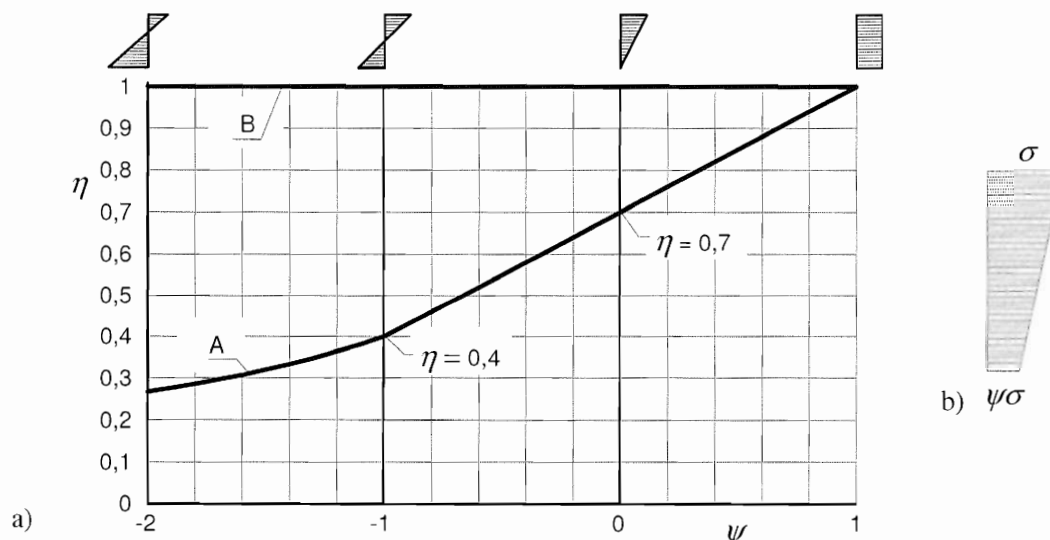
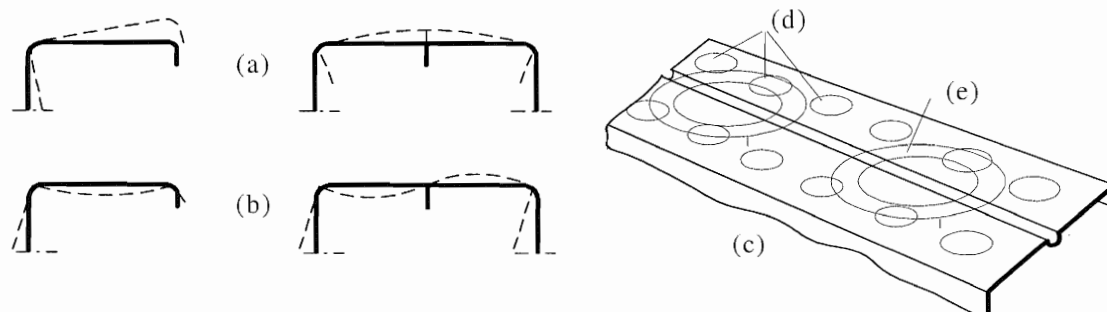

Figure 6.2 - Flat internal parts under stress gradient, values of η . For internal parts or outstands (peak compression at root) use curve A. For outstands (peak compression at toe) use line B.

(2) When considering the susceptibility of a reinforced flat part to local buckling, three possible buckling modes should be considered, as shown in Figure 6.3. Separate values of β should be found for each mode. The modes are:

- a) Mode 1: the reinforced part buckles as a unit, so that the reinforcement buckles with the same curvature as the part. This mode is often referred to as distortional buckling.
- b) Mode 2: the sub-parts and the reinforcement buckle as individual parts with the junction between them remaining straight.
- c) Mode 3: this is a combination of Modes 1 and 2 in which sub-part buckles are superimposed on the buckles of the whole part. This is indicated in Figure 6.3(c).



(a) Mode 1, (b) mode 2, (c) mode 3, (d) sub-part buckles, (e) whole reinforced part buckles.

Figure 6.3 - Buckling modes for flat reinforced parts

(3) Values of β are found as follows:

a) Mode 1, uniform compression, standard reinforcement:

When the reinforcement is a single-sided rib or lip of thickness equal to the part thickness t ,

$$\beta = \eta \frac{b}{t} \quad (6.6)$$

where η is given in expressions (6.7a), (6.7b) or (6.7c), or is read from Figure 6.4(a), (b) or (c). In this figure the depth c of the rib or lip is measured to the inner surface of the plate.

$$\eta = \frac{1}{\sqrt{1 + 0,1(c/t - 1)^2}} \quad (\text{Figure 6.4a}) \quad (6.7a)$$

$$\eta = \frac{1}{\sqrt{1 + 2,5 \frac{(c/t - 1)^2}{b/t}}} \geq 0,5 \quad (\text{Figure 6.4b}) \quad (6.7b)$$

$$\eta = \frac{1}{\sqrt{1 + 4,5 \frac{(c/t - 1)^2}{b/t}}} \geq 0,33 \quad (\text{Figure 6.4c}) \quad (6.7c)$$

b) Mode 1, uniform compression, non-standard reinforcement:

With any other single shape of reinforcement, the reinforcement is replaced by an equivalent rib or lip equal in thickness to the part (t). The value of c for the equivalent rib or lip is chosen so that the second moment of area of the reinforcement about the mid-plane of the plate part is equal to that of the non-standard reinforcement about the same plane. An alternative method is given in 6.6.

c) Mode 1, uniform compression, complex reinforcement:

For unusual shapes of reinforcement not amenable to the analysis described above,

$$\beta = \frac{b}{t} \left(\frac{\sigma_{cr0}}{\sigma_{cr}} \right)^{0,4} \quad (6.8)$$

σ_{cr} is the elastic critical stress for the reinforced part assuming simply supported edges

σ_{cr0} is the elastic critical stress for the unreinforced part assuming simply supported edges.

d) Mode 1, stress gradient:

The value of β is found from the expression (6.8), where σ_{cr} and σ_{cr0} now relate to the stress at the more heavily compressed edge of the part.

e) Mode 2:

The value of β is found separately for each sub-part in accordance with **EN** 6.1.4.3(1) **EN**.

(4) The susceptibility of a uniformly compressed shallow curved unreinforced internal part to local buckling is defined by β , where:

$$\beta = \frac{b}{t} \frac{1}{\sqrt{1 + 0,006 \frac{b^4}{R^2 t^2}}} \quad (6.9)$$

R is radius of curvature to the mid-thickness of material

b is developed width of the part at mid-thickness of material

t is thickness.

The above treatment is valid if $R/b > 0,1b/t$. Sections containing more deeply curved parts require special study or design by testing.

(5) The susceptibility of a thin-walled round tube to local buckling, whether in uniform compression or in bending is defined by β , where:

$$\beta = 3 \sqrt{\frac{D}{t}} \tag{6.10}$$

(6.10)

D = diameter to mid-thickness of tube material.

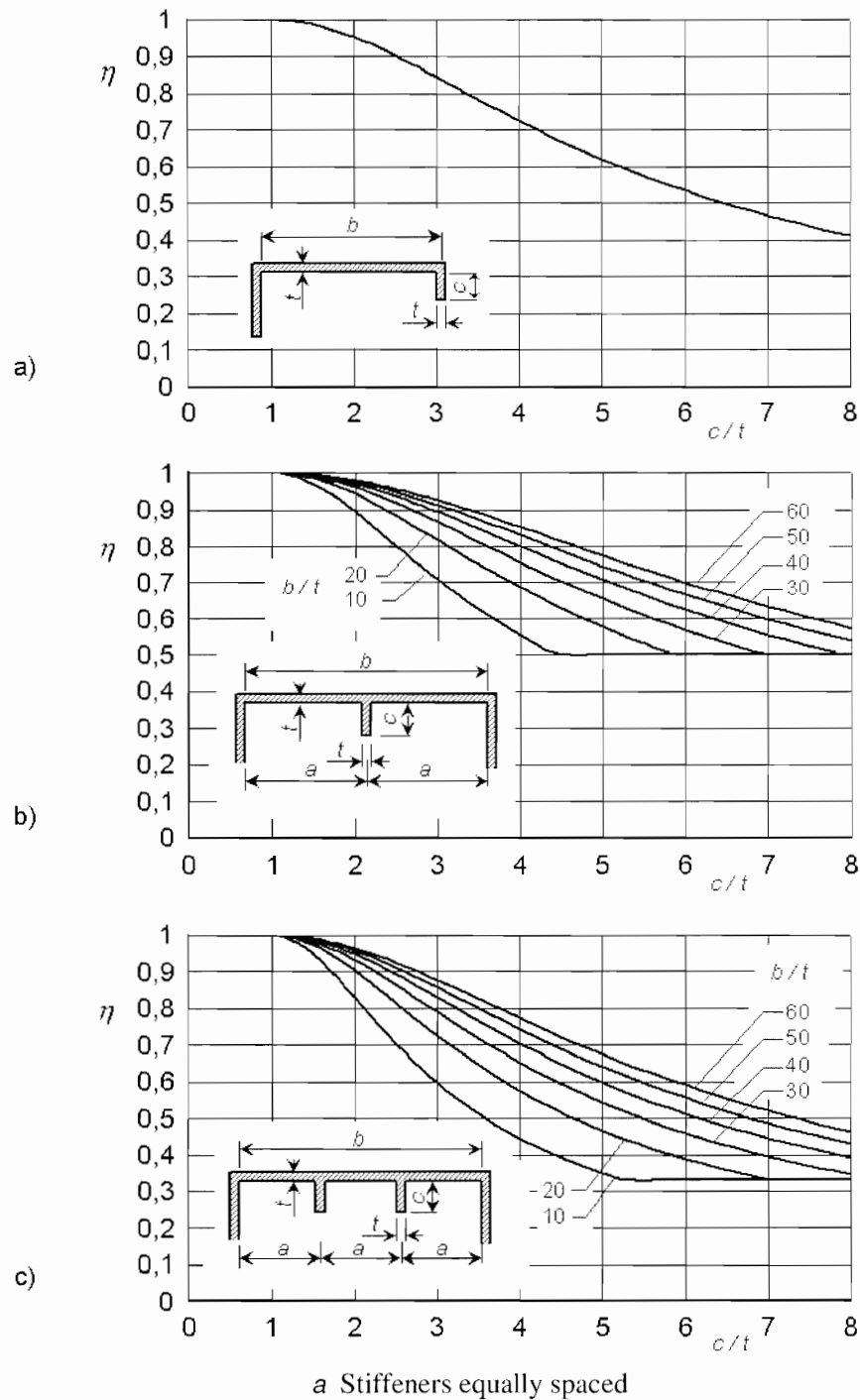

Figure 6.4 - Values of η for reinforced cross section parts

6.1.4.4 Classification of cross-section parts

(1) The classification of parts of cross-sections is linked to the values of the slenderness parameter β as follows:

Parts in beams

- $\beta \leq \beta_1$: class 1
- $\beta_1 < \beta \leq \beta_2$: class 2
- $\beta_2 < \beta \leq \beta_3$: class 3
- $\beta_3 < \beta$: class 4

Parts in struts

- $\beta \leq \beta_2$: class 1 or 2
- $\beta_2 < \beta \leq \beta_3$: class 3
- $\beta_3 < \beta$: class 4

(2) Values of β_1 , β_2 and β_3 are given in Table 6.2.

Table 6.2 - Slenderness parameters β_1/ϵ , β_2/ϵ and β_3/ϵ

Material classification according to Table 3.2	Internal part			Outstand part		
	β_1/ϵ	β_2/ϵ	β_3/ϵ	β_1/ϵ	β_2/ϵ	β_3/ϵ
Class A, without welds	11	16	22	3	4,5	6
Class A, with welds	9	13	18	2,5	4	5
Class B, without welds	13	16,5	18	3,5	4,5	5
Class B, with welds	10	13,5	15	3	3,5	4
$\epsilon = \sqrt{250/f_0}$, f_0 in N/mm ²						

(3) In the Table 6.2, a cross-section part is considered with welds if it contains welding at an edge or at any point within its width. However, a cross-sections part may be considered as without welds if the welds are transversal to the member axis and located at a position of lateral restraint.

NOTE In a cross-section part with welds the classification is independent of the extent of the HAZ.

(4) When classifying parts in members under bending, if the parts are less highly stressed than the most severely stressed fibres in the section, a modified expression $\epsilon = \sqrt{(250/f_0)(z_1/z_2)}$ may be used. In this expression, z_1 is the distance from the elastic neutral axis of the effective section to the most severely stressed fibres, and z_2 is the distance from the elastic neutral axis of the effective section to the part under consideration. z_1 and z_2 should be evaluated on the effective section by means of an iterative procedure (minimum two steps).

6.1.5 Local buckling resistance

(1) Local buckling in class 4 members is generally allowed for by replacing the true section by an effective section. The effective section is obtained by employing a local buckling factor ρ_c to factor down the thickness. ρ_c is applied to any uniform thickness class 4 part that is wholly or partly in compression. Parts that are not uniform in thickness require a special study.

(2) The factor ρ_c is given by expressions (6.11) or (6.12), separately for different parts of the section, in terms of the ratio β/ϵ , where β is found in 6.1.4.3, ϵ is defined in Table 6.2 and the constants C_1 and C_2 in Table 6.3. The relationships between ρ_c and β/ϵ are summarised in Figure 6.5.

$$\rho_c = 1,0 \quad \text{if } \beta \leq \beta_3 \quad (6.11)$$

$$\rho_c = \frac{C_1}{(\beta/\epsilon)} - \frac{C_2}{(\beta/\epsilon)^2} \quad \text{if } \beta > \beta_3 \quad (6.12)$$

Table 6.3 - Constants C_1 and C_2 in expressions for ρ_c

Material classification according to Table 3.2	Internal part		Outstand part	
	C_1	C_2	C_1	C_2
Class A, without welds	32	220	10	24
Class A, with welds	29	198	9	20
Class B, without welds	29	198	9	20
Class B, with welds	25	150	8	16

(3) For flat outstand parts in unsymmetrical cross-sections (Figure 6.1), ρ_c is given by the above expressions for flat outstand in symmetrical sections, but not more than $120/(\beta/\epsilon)^2$.

(4) For reinforced cross-section parts: Consider all possible modes of buckling, and take the lower value of ρ_c . In the case of mode 1 buckling the factor ρ_c should be applied to the area of the reinforcement as well as to the basic plate thickness. See also 6.7. For reinforced outstand cross section part use curve for outstands, otherwise curve for internal cross section part.

(5) For the determination of ρ_c in sections required to carry biaxial bending or combined bending and axial load, see notes in 6.3.3(4).

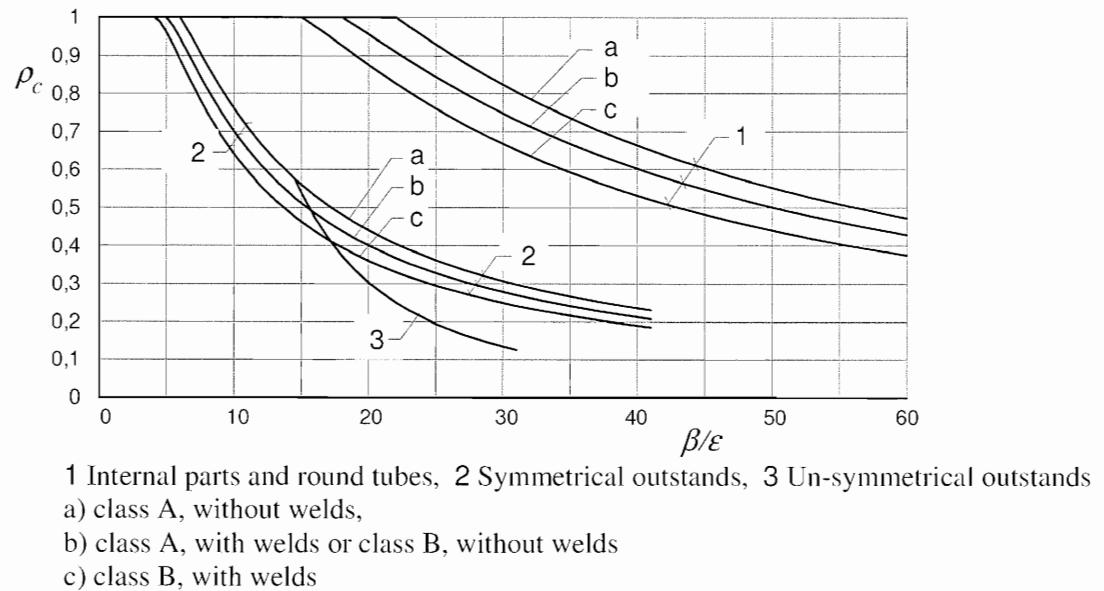

Figure 6.5 - Relationship between ρ_c and β/ϵ for outstands, internal parts and round tubes

6.1.6 HAZ softening adjacent to welds

6.1.6.1 General

(1)P In the design of welded structures using strain hardened or artificially aged precipitation hardening alloys the reduction in strength properties that occurs in the vicinity of welds shall be allowed for.

(2) Exceptions to this rule, where there is no weakening adjacent to welds, occur in alloys in the O-condition; or if the material is in the F condition and design strength is based on O-condition properties.

(3) For design purposes it is assumed that throughout the heat affected zone (HAZ) the strength properties are reduced on a constant level.

NOTE 1 The reduction affects the 0,2% proof strength of the material more severely than the ultimate tensile strength. The affected region extends immediately around the weld, beyond which the strength properties rapidly recover to their full unwelded values.

NOTE 2 Even small welds to connect a small attachment to a main member may considerably reduce the resistance of the member due to the presence of a HAZ. In beam design it is often beneficial to locate welds and attachments in low stress areas, i.e. near the neutral axis or away from regions of high bending moment.

NOTE 3 For some heat treatable alloys it is possible to mitigate the effects of HAZ softening by means of artificial ageing applied after welding.

6.1.6.2 Severity of softening

(1)The characteristic value of the 0,2 % proof strengths $f_{o,haz}$ and the ultimate strength $f_{a,haz}$ in the heat affected zone are listed in Table 3.2. Table 3.2 also gives the reduction factors

$$\rho_{o,haz} = \frac{f_{o,haz}}{f_o} \quad (6.13)$$

$$\rho_{u,haz} = \frac{f_{u,haz}}{f_u} \quad (6.14)$$

NOTE Values for other alloys and tempers must be found and defined by testing. If general values are wanted, testing series are necessary to allow for the fact that material from different manufactures of semi products may vary in chemical composition and therefore may show different strength values after welding. In some cases it is also possible to derive strength values from values of well-known alloys by interpolation.

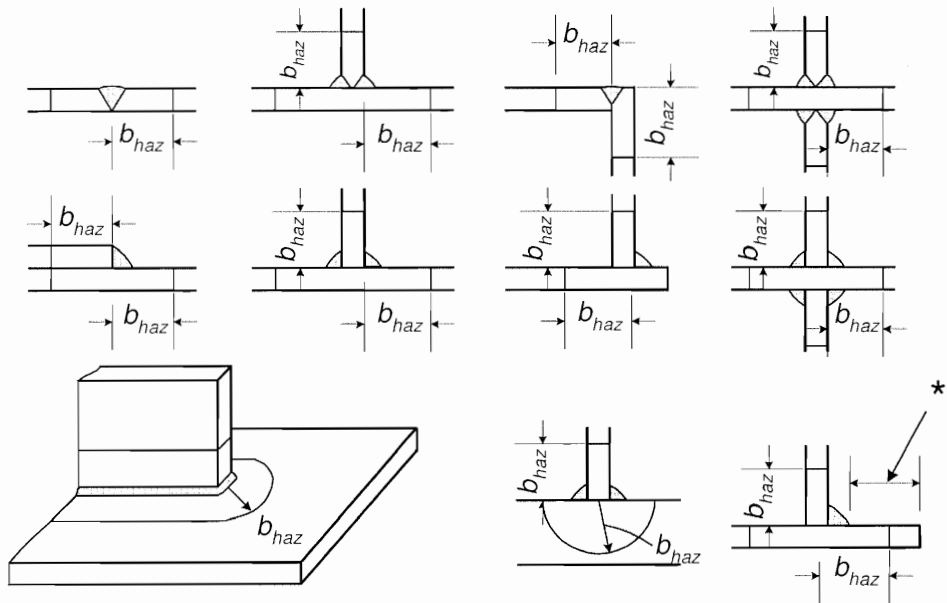

*) If this distance is less than $3b_{haz}$ assume that the HAZ extends to the full width of outstand, see 6.1.6.3(7)

Figure 6.6 - The extent of heat-affected zones (HAZ)

(2) The values of $f_{o,haz}$ and $f_{u,haz}$ in Table 3.2 are valid from the following times after welding, providing the material has been held at a temperature not less than 10°C:

- 6xxx series alloys 3 days
- 7xxx series alloys 30 days.

NOTE 1 If the material is held at a temperature below 10°C after welding, the recovery time will be prolonged. Advice should be sought from manufacturers.

NOTE 2 The severity of softening can be taken into account by the characteristic value of strength $f_{o,haz}$ and $f_{u,haz}$ in the HAZ (Table 3.2) as for the parent metal, or by reducing the assumed cross-sectional area over which the stresses act with the factors $\rho_{o,haz}$ and $\rho_{u,haz}$ (Table 3.2). Thus the characteristic resistance of a simple rectangular section affected by HAZ softening can be expressed as $A f_{u,haz} = (\rho_{u,haz} A) f_u$ if the design is dominated by ultimate strength or as $A f_{o,haz} = (\rho_{o,haz} A) f_o$ if the design is dominated by the 0,2% proof strength.

6.1.6.3 Extent of HAZ

(1) The HAZ is assumed to extend a distance b_{haz} in any direction from a weld, measured as follows (see Figure 6.6).

- a) transversely from the centre line of an in-line butt weld;
- b) transversely from the point of intersection of the welded surfaces at fillet welds;
- c) transversely from the point of intersection of the welded surfaces at butt welds used in corner, tee or cruciform joints;
- d) in any radial direction from the end of a weld.

(2) The HAZ boundaries should generally be taken as straight lines normal to the metal surface, particularly if welding thin material. However, if surface welding is applied to thick material it is permissible to assume a curved boundary of radius b_{haz} , as shown in Figure 6.6.

(3) For a MIG weld laid on unheated material, and with interpass cooling to 60°C or less when multi-pass welds are laid, values of b_{haz} are as follows:

$$0 < t \leq 6 \text{ mm: } b_{\text{haz}} = 20 \text{ mm}$$

$$6 < t \leq 12 \text{ mm: } b_{\text{haz}} = 30 \text{ mm}$$

$$12 < t \leq 25 \text{ mm: } b_{\text{haz}} = 35 \text{ mm}$$

$$t > 25 \text{ mm: } b_{\text{haz}} = 40 \text{ mm}$$

(4) For thickness > 12 mm there may be a temperature effect, because interpass cooling may exceed 60°C unless there is strict quality control. This will increase the width of the heat affected zone.

(5) The above figures apply to in-line butt welds (two valid heat paths) or to fillet welds at T-junctions (three valid heat paths) in A7 6xxx and 7xxx series alloys, and in 3xxx and 5xxx series A1 alloys in the work-hardened condition.

(6) For a TIG weld the extent of the HAZ is greater because the heat input is greater than for a MIG weld. TIG welds for in-line butt or fillet welds in 6xxx, 7xxx A7 and work-hardened 3xxx and 5xxx series A1 alloys, have a value of b_{haz} given by:

$$0 < t \leq 6 \text{ mm: } b_{\text{haz}} = 30 \text{ mm}$$

(7) If two or more welds are close to each other, their HAZ boundaries overlap. A single HAZ then exists for the entire group of welds. If a weld is located too close to the free edge of an outstand the dispersal of heat is less effective. This applies if the distance from the edge of the weld to the free edge is less than $3b_{\text{haz}}$. In these circumstances assume that the entire width of the outstand is subject to the factor $\rho_{\text{o,haz}}$.

(8) Other factors that affect the value of b_{haz} are as follows:

a) Influence of temperatures above 60°C

When multi-pass welds are being laid down, there could be a build-up of temperature between passes. This results in an increase in the extent of the HAZ. A7 If the interpass temperature T_1 (°C) is between 60°C and 120°C, it is conservative for 6xxx, 7xxx and work-hardened 3xxx and 5xxx series alloys to multiply b_{haz} by a factor α_2 as follows: A1

- 6xxx alloys A7 and work-hardened 3xxx and 5xxx series A1 alloys: $\alpha_2 = 1 + (T_1 - 60) / 120$;

- 7xxx alloys: $\alpha_2 = 1 + 1,5(T_1 - 60) / 120$.

If a less conservative value of α_2 is desired, hardness tests on test specimens will indicate the true extent of the HAZ. A temperature of 120°C is the maximum recommended temperature for welding aluminium alloys.

b) Variations in thickness

If the cross-section parts to be joined by welds do not have a common thickness t , it is conservative to assume in all the above expressions that t is the average thickness of all parts. This applies as long as the average thickness does not exceed 1,5 times the smallest thickness. For greater variations of thickness, the extent of the HAZ should be determined from hardness tests on specimens.

c) Variations in numbers of heat paths

If the junctions between cross-section parts are fillet welded, but have different numbers of heat paths (n) from the three designated at (5) above, multiply the value of b_{haz} by $3/n$.

6.2 Resistance of cross-sections

6.2.1 General

(1)P The design value of an action effect in each cross-section shall not exceed the corresponding design resistance and if several action effects act simultaneously the combined effect shall not exceed the resistance for that combination.

(2) Shear lag effects should be included by an effective width. Local buckling effects should be included by an effective thickness, see 6.1.5. As an alternative, equivalent effective width may also be used.

NOTE For the effect of shear lag, see Annex K

(3) The design values of resistance depend on the classification of the cross-section.

(4) Verification according to elastic resistance may be carried out for all cross-sectional classes provided the effective cross-sectional properties are used for the verification of class 4 cross-sections.

(5) For the resistance the following yield criterion for a critical point of the cross-section may be used unless other interaction formulae apply, see 6.2.7 to 6.2.10.

$$\left(\frac{\sigma_{x,Ed}}{f_o/\gamma_{M1}}\right)^2 + \left(\frac{\sigma_{z,Ed}}{f_o/\gamma_{M1}}\right)^2 - \left(\frac{\sigma_{x,Ed}}{f_o/\gamma_{M1}}\right)\left(\frac{\sigma_{z,Ed}}{f_o/\gamma_{M1}}\right) + 3\left(\frac{\tau_{Ed}}{f_o/\gamma_{M1}}\right)^2 \leq C \quad (6.15)$$

$$\frac{\sigma_{x,Ed}}{f_o/\gamma_{M1}} \leq 1, \quad \frac{\sigma_{z,Ed}}{f_o/\gamma_{M1}} \leq 1 \quad \text{and} \quad \frac{\sqrt{3}\tau_{Ed}}{f_o/\gamma_{M1}} \leq 1 \quad (6.15 \text{ a, b, c})$$

where:

$\sigma_{x,Ed}$ is the design value of the local longitudinal stress at the point of consideration

$\sigma_{z,Ed}$ is the design value of the local transverse stress at the point of consideration

τ_{Ed} is the design value of the local shear stress at the point of consideration

$C \geq 1$ is a constant, see NOTE 2

NOTE 1 The verification according to 6.2.1(5) can be conservative as it only partially allow for plastic stress distribution, which is permitted in elastic design. Therefore it should only be performed where the interaction on the basis of resistances cannot be performed.

NOTE 2 The constant C in criterion (6.15) may be defined in the National Annex. The numerical value $C = 1,2$ is recommended.

6.2.2 Section properties

6.2.2.1 Gross cross-section

(1) The properties of the gross cross-section (A_g) should be found by using the nominal dimensions. Holes for fasteners need not be deducted, but allowance should be made for larger openings. Splice materials and battens should not be included.

6.2.2.2 Net area

(1) The net area of a cross-section (A_{net}) should be taken as the gross area less appropriate deductions for holes, other openings and heat affected zones.

(2) For calculating net section properties, the deduction for a single fastener hole should be the A_1 text deleted A_1 cross-sectional area of the hole in the plane of its axis. For countersunk holes, appropriate allowance should be made for the countersunk portion.

(3) Provided that the fastener holes are not staggered, the total area to be deducted for the fastener holes should be the maximum sum of the sectional areas of the holes in any cross-section perpendicular to the member axis (see failure plane I in Figure 6.7).

NOTE The maximum sum denotes the position of the critical failure line.

(4) Where the fastener holes are staggered, the total area to be deducted for fastener holes should be the greater of (see Figure 6.7):

- the deduction for non-staggered holes given in (3)
- a deduction taken as $\sum t d - \sum t b_s$ where b_s is the lesser of

$$s^2/(4p) \quad \text{or} \quad 0,65s \quad (6.16)$$

where:

- d is the diameter of hole
- s is staggered pitch, the spacing of the centres of two consecutive holes in the chain measured parallel to the member axis
- p is the spacing of the $\overline{A_1}$ centres of the same two holes measured perpendicular to the member axis
- t is the thickness (or effective thickness in a member containing HAZ material).

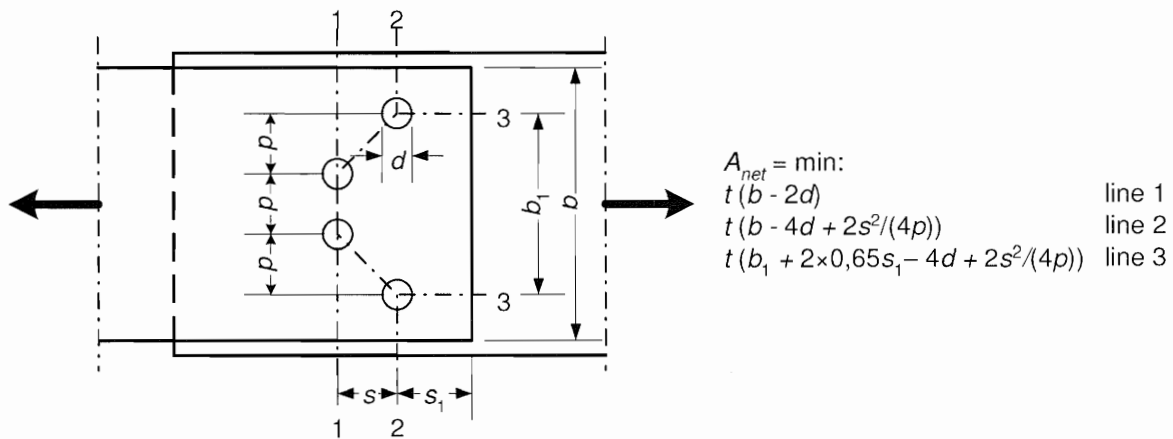

Figure 6.7 - Staggered holes and critical fracture lines 1, 2 and 3

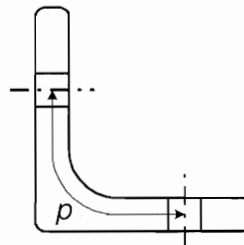

Figure 6.8 - Angles with holes in both legs

$\overline{A_1}$ (5) In an angle or other member with holes in more than one plane, the spacing p should be measured along the centre $\overline{A_1}$ of thickness of the material (see Figure 6.8).

6.2.2.3 Shear lag effects

(1) The effect of shear lag on the buckling and rupture resistance of flanges should be taken into account.

NOTE Recommendations for the effect of shear lag are given in Annex K.

6.2.3 Tension

(1)P The design value of the tensile force N_{Ed} shall satisfy:

$$\frac{N_{Ed}}{N_{t,Rd}} \leq 1,0 \quad (6.17)$$

$\overline{A_1}$ NOTE Eccentricity due to the shift of centroidal axis of asymmetric welded sections may be neglected. $\overline{A_1}$

(2) The design tension resistance of the cross-section $N_{t,Rd}$ should be taken as the lesser of $N_{o,Rd}$ and $N_{u,Rd}$ where:

a) general yielding along the member: $N_{o,Rd} = A_g f_o / \gamma_{M1}$ (6.18)

b) local failure at a section with holes: $N_{u,Rd} = 0,9 A_{net} f_u / \gamma_{M2}$ (6.19a)

c) local failure at a section with HAZ: $N_{u,Rd} = A_{eff} f_u / \gamma_{M2}$ (6.19b)

where:

A_g is either the gross section or a reduced cross-section to allow for HAZ softening due to longitudinal welds. In the latter case A_g is found by taking a reduced area equal to $\rho_{o,haz}$ times the area of the HAZ, see 6.1.6.2

A_{net} is the net section area, with deduction for holes and a deduction if required to allow for the effect of HAZ softening in the net section through the hole. The latter deduction is based on the reduced thickness of $\rho_{u,haz}t$.

A_{eff} is the effective area based on the reduced thickness of $\rho_{u,haz}t$.

(3) For angles connected through one leg [A1] see 8.5.2.3 [A1] . Similar consideration should also be given to other types of sections connected through outstands such as T-sections and channels.

[A1] (4) [A1] For staggered holes, see 6.2.2.2.

6.2.4 Compression

(1)P The design value of the axial compression force N_{Ed} shall satisfy:

$$\frac{N_{Ed}}{N_{c,Rd}} \leq 1,0 \quad (6.20)$$

[A1] NOTE Eccentricity due to the shift of centroidal axis of asymmetric welded sections may be neglected. [A1]

(2) The design resistance for uniform compression $N_{c,Rd}$ should be taken as the lesser of $N_{u,Rd}$ and $N_{c,Rd}$ where :

a) in sections with unfilled holes $N_{u,Rd} = A_{net} f_u / \gamma_{M2}$ (6.21)

b) other sections $N_{c,Rd} = A_{eff} f_o / \gamma_{M1}$ (6.22)

in which:

A_{net} is the net section area, with deductions for unfilled holes and HAZ softening if necessary. See 6.2.2.2. For holes located in reduced thickness regions the deduction may be based on the reduced thickness, instead of the full thickness.

A_{eff} is the effective section area based on reduced thickness allowing for local buckling and HAZ softening but ignoring unfilled holes.

6.2.5 Bending moment

6.2.5.1 Basis

(1)P The design value of the bending moment M_{Ed} at each cross section shall satisfy

$$\frac{M_{Ed}}{M_{Rd}} \leq 1,0 \quad (6.23)$$

[A1] NOTE Eccentricity due to the shift of centroidal axis of asymmetric welded sections may be neglected. [A1]

(2) The design resistance for bending about one principal axis of a cross section M_{Rd} is determined as the lesser of $M_{u,Rd}$ and [A1] $M_{o,Rd}$ [A1] where:

$$M_{u,Rd} = W_{net} f_u / \gamma_{M2} \quad \text{in a net section and} \quad (6.24)$$

$$\text{[A1]}$$
 $M_{o,Rd} = \alpha W_{el} f_o / \gamma_{M1}$ at each cross-section (6.25) [A1]

where:

α is the shape factor, see Table 6.4

W_{el} is the elastic modulus of the gross section (see 6.2.5.2)

W_{net} is the elastic modulus of the net section allowing for holes and HAZ softening, if welded (see 6.2.5.2). The latter deduction is based on the reduced thickness of $\rho_{u,haz}t$.

Table 6.4 - Values of shape factor α

Cross-section class	Without welds	With longitudinal welds
1	$W_{pl} / W_{el}^{*})$	$W_{pl,haz} / W_{el}^{*})$
2	W_{pl} / W_{el}	$W_{pl,haz} / W_{el}$
3	$\alpha_{3,u}$	$\alpha_{3,w}$
4	W_{eff} / W_{el}	$W_{eff,haz} / W_{el}$
*) NOTE These formulae are on the conservative side. For more refined value, recommendations are given in Annex F		

In Table 6.4 the various section moduli W and $\alpha_{3,u}$, $\alpha_{3,w}$ are defined as:

W_{pl} plastic modulus of gross section

W_{eff} effective elastic section modulus, obtained using a reduced thickness t_{eff} for the class 4 parts (see 6.2.5.2)

$W_{el,haz}$ effective elastic modulus of the gross section, obtained using a reduced thickness $\rho_{o,haz}t$ for the HAZ material (see 6.2.5.2)

$W_{pl,haz}$ effective plastic modulus of the gross section, obtained using a reduced thickness $\rho_{o,haz}t$ for the HAZ material (see 6.2.5.2)

$W_{eff,haz}$ effective elastic section modulus, obtained using a reduced thickness $\rho_c t$ for the class 4 parts or a reduced thickness $\rho_{o,haz}t$ for the HAZ material, whichever is the smaller (see 6.2.5.2)

$\alpha_{3,u} = 1$ or may alternatively be taken as:

$$\alpha_{3,u} = \left[1 + \left(\frac{\beta_3 - \beta}{\beta_3 - \beta_2} \right) \left(\frac{W_{pl}}{W_{el}} - 1 \right) \right] \quad (6.26)$$

$\alpha_{3,w} = W_{el,haz} / W_{el}$ or may alternatively be taken as:

$$\alpha_{3,w} = \left[\frac{W_{el,haz}}{W_{el}} + \left(\frac{\beta_3 - \beta}{\beta_3 - \beta_2} \right) \left(\frac{W_{pl,haz} - W_{el,haz}}{W_{el}} \right) \right] \quad (6.27)$$

where:

β is the slenderness parameter for the most critical part in the section

β_2 and β_3 are the limiting values for that same part according to Table 6.2.

The critical part is determined by the lowest value of $\frac{A_1}{A_2} \beta_2 / \beta \frac{A_1}{A_2}$

(3) Refer to 6.2.8 for combination of bending moment and shear force.

(4) In addition, the resistance of the member to lateral-torsional buckling should also be verified, see 6.3.2.

6.2.5.2 Design cross section

(1) The terminology used in this section is as follows:

a) net section includes the deduction for holes and includes the allowance for reduced material strength taken in the vicinity of the welds to allow for HAZ softening, if welded.

b) effective section includes the allowance for HAZ softening and local buckling, but with no reduction for holes. See Figure 6.9.

(2) In items a) and b) above the allowance for reductions in material strength should generally be taken as follows for the various parts in the section:

a) Class 4 part free of HAZ effects. A value $t_{eff} = \rho_c t$ is taken for the compressed portion of the cross-section part, where ρ_c is found as in 6.1.5. Application of an effective section can result in an iteration procedure. See 6.7.

b) Class 1, 2 or 3 parts subject to HAZ effects. A value $\rho_{o,haz} t$ is taken in the softened portions of the cross-section part, where $\rho_{o,haz}$ and the extent of the softening are as given in 6.1.6.2 and 6.1.6.3.

c) Class 4 part with HAZ effects. The allowance is taken as the lesser of that corresponding to the reduced thickness t_{eff} and that corresponding to the reduced thickness in the softened part, $\rho_{o,haz} t$ and as t_{eff} in the rest of the compressed portion of the cross-section part. See Figure 6.9.

d) In the case of reinforced cross-section parts (see 6.1.4.3(2)), ρ_c should be applied to the area of the reinforcement as well as to the basic plate thickness.

e) For a welded part in a Class 3 or 4 section a more favourable assumed thickness may be taken as follows:

- HAZ softening is ignored in any material at distance less than $\rho_{o,haz} z_1$ from the elastic neutral axis of the gross section, where z_1 is the distance from there to the furthest extreme fibres of the section.
- For HAZ material, at a distance $z (> \rho_{o,haz} z_1)$ from the neutral axis, $\rho_{o,haz}$ may be replaced by a value ρ_{zy} determined as $\rho_{zy} = \rho_{o,haz} + 1 - z / z_1$.

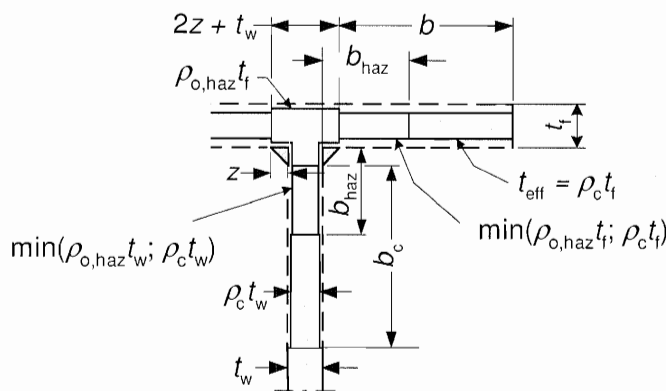

Figure 6.9 - Effective thickness in class 4 cross-section with welds

6.2.6 Shear

(1)P The design value of the shear force V_{Ed} at each cross-section shall satisfy:

$$\frac{V_{Ed}}{V_{Rd}} \leq 1,0 \quad (6.28)$$

where:

V_{Rd} is the design shear resistance of the cross-section.

(2) For non-slender sections, $h_w / t_w < 39\epsilon$, see 6.5.5(2)

$$V_{Rd} = A_v \frac{f_o}{\sqrt{3} \gamma_{M1}} \quad (6.29)$$

where A_v is the shear area, taken as:

a) For sections containing shear webs

$$A_v = \sum_{i=1}^n \left[(h_w - \sum d)(t_w)_i - (1 - \rho_{o,haz}) b_{haz} (t_w)_i \right] \quad (6.30)$$

where:

h_w is the depth of the web between flanges.

b_{haz} is the total depth of HAZ material occurring between the clear depth of the web between flanges. For sections with no welds, $\rho_{o,haz} = 1$. If the HAZ extends the entire depth of the web panel $b_{haz} = h_w - \sum d$

t_w is the web thickness

d is the diameter of holes along the shear plane

n is the number of webs.

b) For a solid bar and a round tube

$$A_v = \eta_v A_e \quad (6.31)$$

where:

$\eta_v = 0,8$ for a solid bar

$\eta_v = 0,6$ for a round tube

A_e is the full section area of an unwelded section, and the effective section area obtained by taking a reduced thickness $\rho_{o,haz} t$ for the HAZ material of a welded section.

(3) For slender webs and stiffened webs, see 6.7.4 - 6.7.6.

(4) Where a shear force is combined with a torsional moment, the shear resistance V_{Rd} should be reduced as specified in 6.2.7(9).

6.2.7 Torsion

6.2.7.1 Torsion without warping

(1)P For members subjected to torsion for which distortional deformations and warping torsion may be disregarded the design value of the torsional moment T_{Ed} at each cross-section shall satisfy:

$$\frac{T_{Ed}}{T_{Rd}} \leq 1,0 \quad (6.32)$$

where:

$T_{Rd} = W_{T,pl} f_o / (\sqrt{3} \gamma_{M1})$ is the design St.Venants torsion moment resistance of the cross-section in which $W_{T,pl}$ is the plastic torsion modulus.

NOTE 1 If the resultant force is acting through the shear centre there is no torsional moment due to that loading.

NOTE 2 Formulae for the shear centre for some frequent cross-sections are given in Annex J

(2) For the calculation of the resistance T_{Rd} of hollow sections with slender cross section parts the design shear strength of the individual parts of the cross-section should be taken into account according to 6.7.4 or 6.7.5.

6.2.7.2 Torsion with warping

(1) For members subjected to torsion for which distortional deformations may be disregarded but not warping torsion the total torsional moment at any cross-section should be considered as the sum of two internal effects:

$$T_{Ed} = T_{t,Ed} + T_{w,Ed} \quad (6.33)$$

where:

$T_{t,Ed}$ is the internal St. Venants torsion moment;

$T_{w,Ed}$ is the internal warping torsion moment.

(2) The values of $T_{t,Ed}$ and $T_{w,Ed}$ at any cross-section may be determined from T_{Ed} by elastic analysis, taking account of the section properties of the member, the condition of restraint at the supports and the distribution of the actions along the member,

NOTE No expression for resistance T_{Rd} can be given in this case

(3) The following stresses due to torsion should be taken into account:

- the shear stresses $\tau_{t,Ed}$ due to St. Venant torsion moment $T_{t,Ed}$
- the direct stresses $\sigma_{w,Ed}$ due to the bimoment B_{Ed} and shear stresses $\tau_{w,Ed}$ due to warping torsion moment $T_{w,Ed}$.

NOTE Cross section constants are given in Annex J.

(4) For elastic resistance the yield criterion in 6.2.1(5) may be applied.

(5) For determining the moment resistance of a cross-section due to bending and torsion only, torsion effects B_{Ed} should be derived from elastic analysis, see (3).

(6) As a simplification, in the case of a member with open cross section, such as I or H, it may be assumed that the effect of St. Venant torsion moment can be neglected.

6.2.7.3 Combined shear force and torsional moment

(1)P For combined shear force and torsional moment the shear force resistance accounting for torsional effects shall be reduced from V_{Rd} to $V_{T,Rd}$ and the design shear force shall satisfy:

$$\frac{V_{Ed}}{V_{T,Rd}} \leq 1,0 \quad (6.34)$$

in which $V_{T,Rd}$ may be derived as follows:

- for an I or H section

$$V_{T,Rd} = \sqrt{1 - \frac{\tau_{t,Ed} \sqrt{3}}{1,25 f_o / \gamma_{M1}}} V_{Rd} \quad (6.35)$$

- for a channel section:

$$V_{T,Rd} = \left[\sqrt{1 - \frac{\tau_{t,Ed} \sqrt{3}}{1,25 f_o / \gamma_{M1}}} - \frac{\tau_{w,Ed} \sqrt{3}}{f_o / \gamma_{M1}} \right] V_{Rd} \quad (6.36)$$

- for a hollow section

$$V_{T,Rd} = \left[1 - \frac{\tau_{t,Ed} \sqrt{3}}{f_o / \gamma_{M1}} \right] V_{Rd} \quad (6.37)$$

where V_{Rd} is given in 6.2.6.

6.2.8 Bending and shear

(1) Where a shear force is present allowance should be made for its effect on the moment resistance.

(2) If the shear force V_{Ed} is less than half the shear resistance V_{Rd} its effect on the moment resistance may be neglected except where shear buckling reduces the section resistance, see 6.7.6.

(3) Otherwise the reduced moment resistance should be taken as the design resistance of the cross-section, calculated using a reduced strength

$$f_{o,V} = f_o \left(1 - (2V_{Ed} / V_{Rd} - 1)^2 \right) \quad (6.38)$$

where V_{Rd} is obtained from 6.2.6.

(4) In the case of an equal-flanged I-section classified as class 1 or 2 in bending, the resulting value of the reduced moment resistance $M_{v,Rd}$ is:

$$M_{v,Rd} = t_f b_f (h - t_f) \frac{f_o}{\gamma_{M1}} + \frac{t_w h_w^2}{4} \frac{f_{o,V}}{\gamma_{M1}} \quad (6.39)$$

where h is the total depth of the section and h_w is the web depth between inside flanges.

(5) In the case of an equal-flanged I-section classified as class 3 in bending, the resulting value of $M_{v,Rd}$ is given by expression (6.39) but with the denominator 4 in the second term replaced by 6:

A1 (6) For sections classified as class 4 in bending or affected by HAZ softening, see 6.2.5.

(7) Where torsion is present V_{Rd} in expression (6.38) is replaced by $V_{T,Rd}$, see 6.2.7, but $f_{o,V} = f_o$ for $V_{Ed} \leq 0,5V_{T,Rd}$

(8) For the interaction of bending, shear force and transverse loads see 6.7.6. **A1**

6.2.9 Bending and axial force

6.2.9.1 Open cross-sections

(1) For doubly symmetric cross-sections (except solid sections, see 6.2.9.2) the following two criteria should be satisfied:

$$\left(\frac{N_{Ed}}{\omega_0 N_{Rd}} \right)^{\xi_0} + \frac{M_{y,Ed}}{\omega_0 M_{y,Rd}} \leq 1,00 \quad (6.40)$$

$$\left(\frac{N_{Ed}}{\omega_0 N_{Rd}} \right)^{\eta_0} + \left(\frac{M_{y,Ed}}{\omega_0 M_{y,Rd}} \right)^{\gamma_0} + \left(\frac{M_{z,Ed}}{\omega_0 M_{z,Rd}} \right)^{\xi_0} \leq 1,00 \quad (6.41)$$

where:

$$\eta_0 = 1,0 \text{ or may alternatively be taken as } \alpha_z^2 \alpha_y^2 \text{ but } 1 \leq \eta_0 \leq 2 \quad (6.42a)$$

$$\gamma_0 = 1,0 \text{ or may alternatively be taken as } \alpha_z^2 \text{ but } 1 \leq \gamma_0 \leq 1,56 \quad (6.42b)$$

$$\xi_0 = 1,0 \text{ or may alternatively be taken as } \alpha_y^2 \text{ but } 1 \leq \xi_0 \leq 1,56 \quad (6.42c)$$

N_{Ed} is the design values of the axial compression or tension force

$M_{y,Ed}$ and $M_{z,Ed}$ are the bending moments about the y-y and z-z axis

$N_{Rd} = A_{eff} f_0 / \gamma_{M1}$, see 6.2.4.

$M_{y,Rd} = \alpha_y W_{y,el} f_0 / \gamma_{M1}$

$M_{z,Rd} = \alpha_z W_{z,el} f_0 / \gamma_{M1}$

α_y, α_z are the shape factors for bending about the y and z axis, with allowance for local buckling and HAZ softening from longitudinal welds, see 6.2.5.

$\omega_0 = 1$ for sections without localized welds or holes. Otherwise, see 6.2.9.3.

NOTE For classification of cross section, see 6.3.3(4).

(2) Criterion (6.41) may also be used for mono-symmetrical cross-sections with $\eta_0 = \alpha_y^2$ (but $1 \leq \eta_0 \leq 2,0$) and $\gamma_0 = \xi_0 = 1$, where $\alpha_y = \max(\alpha_{y1}, \alpha_{y2})$, see Figure 6.10, if the axial force and the bending moment give stresses with the same sign in the larger flange and $\alpha_y = \min(\alpha_{y1}, \alpha_{y2})$ if the axial force and the bending moment give stresses with the same sign in the smaller flange.

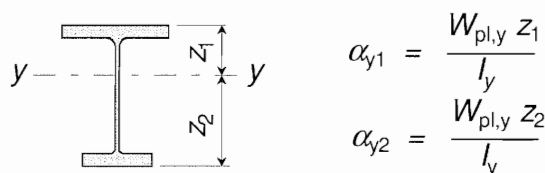

Figure 6.10 - Shape factor for a mono-symmetrical class 1 or 2 cross-section

6.2.9.2 Hollow sections and solid cross-sections

(1) Hollow sections and solid cross-sections should satisfy the following criterion:

$$\left(\frac{N_{Ed}}{\omega_0 N_{Rd}} \right)^\psi + \left[\left(\frac{M_{y,Ed}}{\omega_0 M_{y,Rd}} \right)^{1,7} + \left(\frac{M_{z,Ed}}{\omega_0 M_{z,Rd}} \right)^{1,7} \right]^{0,6} \leq 1,00 \quad (6.43)$$

where $\psi = 1,3$ for hollow sections and $\psi = 2$ for solid cross-sections. Alternatively ψ may be taken as $\alpha_y \alpha_z$ but $1 \leq \psi \leq 1,3$ for hollow sections and $1 \leq \psi \leq 2$ for solid cross-sections.

6.2.9.3 Members containing localized welds

(1) If a section is affected by HAZ softening with a specified location along the length and if the softening does not extend longitudinally a distance greater than the least width of the member, then the limiting stress should be taken as the design *ultimate strength* $\rho_{u,haz} f_u / \gamma_{M2}$ of the reduced strength material.

$$\omega_0 = (\rho_{u,haz} f_u / \gamma_{M2}) / (f_0 / \gamma_{M1}) \quad (6.44)$$

NOTE This includes HAZ effects due to the welding of temporary attachments.

(2) If the softening A_1 extends A_1 longitudinally a distance greater than the least width of the member the limiting stress should be taken as the strength $\rho_{o,haz} f_0$ for *overall yielding* of the reduced strength material, thus

$$\omega_0 = \rho_{o,haz} \quad (6.45)$$

6.2.10 Bending, shear and axial force

(1) Where shear and axial force are present, allowance should be made for the effect of both shear force and axial force on the resistance of the moment.

(2) Provided that the design value of the shear force V_{Ed} does not exceed 50% of the shear resistance V_{Rd} no reduction of the resistances defined for bending and axial force in 6.2.9 need be made, except where shear buckling reduces the section resistance, see 6.7.6.

(3) Where V_{Ed} exceeds 50% of V_{Rd} the design resistance of the cross-section to combinations of moment and axial force should be reduced using a reduced yield strength

$$(1 - \rho) f_0 \quad (6.46)$$

for the shear area where:

$$\rho = (2V_{Ed} / V_{Rd} - 1)^2 \quad (6.47)$$

and V_{Rd} is obtained from 6.2.6(2).

NOTE Instead of applying reduced yield strength, the calculation may also be performed applying an effective plate thickness.

6.2.11 Web bearing

(1) This clause concerns the design of webs subjected to localised forces caused by concentrated loads or reactions applied to a beam. For un-stiffened and longitudinally stiffened web this subject is covered in 6.7.5.

(2) For transversely stiffened web, the bearing stiffener, if fitted, should be of class 1 or 2 section. It may be conservatively designed on the assumption that it resists the entire bearing force, unaided by the web, the stiffener being checked as a strut (see 6.3.1) for out-of-plane column buckling and local squashing, with lateral bending effects allowed for if necessary (see 6.3.2). See also 6.7.8.

6.3 Buckling resistance of members

6.3.1 Members in compression

(1) Members subject to axial compression may fail in one of three ways:

- a) flexural (see 6.3.1.1 to 6.3.1.3)
- b) torsional or flexural torsional (see 6.3.1.1 and 6.3.1.4)
- c) local squashing (see 6.2.4)

NOTE Check a) should always be made. Check b) is generally necessary but may be waived in some cases. Check c) is only necessary for struts of low slenderness that are significantly weakened locally by holes or welding.

6.3.1.1 Buckling Resistance

(1)P A compression member shall be verified against both flexural and torsional or torsional-flexural buckling as follows:

$$\frac{N_{Ed}}{N_{b,Rd}} \leq 1,0 \quad (6.48)$$

where:

N_{Ed} is the design value of the compression force

$N_{b,Rd}$ is the design buckling resistance of the compression member

(2) The design buckling resistance of a compression member $N_{b,Rd}$ should be taken as:

$$N_{b,Rd} = \kappa \chi A_{eff} f_0 / \gamma_{M1} \quad (6.49)$$

where:

χ is the reduction factor for the relevant buckling mode as given in 6.3.1.2.

κ is a factor to allow for the weakening effects of welding. For longitudinally welded member κ is given in Table 6.5 for flexural buckling and $\kappa = 1$ for torsional and torsional-flexural buckling. In case of transversally welded member $\kappa = \omega_x$ ^[A1] according to 6.3.3.3. $\kappa = 1$ if there are no welds. ^[A1]

A_{eff} is the effective area allowing for local buckling for class 4 cross-section. For torsional and torsional-flexural buckling see Table 6.7.

$A_{eff} = A$ for class 1, 2 or 3 cross-section

6.3.1.2 Buckling curves

(1) For axial compression in members the value of χ for the appropriate value of $\bar{\lambda}$ should be determined from the relevant buckling curve according to:

$$\chi = \frac{1}{\phi + \sqrt{\phi^2 - \bar{\lambda}^2}} \quad \text{but } \chi \leq 1,0 \quad (6.50) \quad [A1]$$

where:

$$\phi = 0,5(1 + \alpha(\bar{\lambda} - \bar{\lambda}_0) + \bar{\lambda}^2)$$

$$\bar{\lambda} = \sqrt{\frac{A_{eff} f_0}{N_{cr}}} \quad (6.51)$$

α is an imperfection factor

$\bar{\lambda}_0$ is the limit of the horizontal plateau

N_{cr} is the elastic critical force for the relevant buckling mode based on the gross cross-sectional properties

^[A1] NOTE In a member with a local weld the slenderness parameter $\bar{\lambda}_{haz}$ according to 6.3.3.3 (3) should be used for the section with the weld ^[A1]

(2) The imperfection factor α and limit of horizontal plateau $\bar{\lambda}_0$ corresponding to appropriate buckling curve should be obtained from Table 6.6 for flexural buckling and Table 6.7 for torsional or torsional-flexural buckling.

(3) Values of the reduction factor χ for the appropriate relative slenderness $\bar{\lambda}$ may be obtained from Figure 6.11 for flexural buckling and Figure 6.12 for torsional or torsional-flexural buckling.

(4) For slenderness $\bar{\lambda} \leq \bar{\lambda}_0$ or for $N_{Ed} \leq \bar{\lambda}_0^2 N_{cr}$ the buckling effects may be ignored and only cross-sectional check apply.

Table 6.5 - Values of κ factor for member with longitudinal welds

Class A material according to Table 3.2	Class B material according to Table 3.2
$\kappa = 1 - \left(1 - \frac{A_1}{A}\right) 10^{-\bar{\lambda}} - \left(0,05 + 0,1 \frac{A_1}{A}\right) \bar{\lambda}^{1,3(1-\bar{\lambda})}$ <p>with $A_1 = A - A_{haz}(1 - \rho_{o,haz})$ in which A_{haz} = area of HAZ</p>	$\kappa = 1 \text{ if } \bar{\lambda} \leq 0,2$ $\kappa = 1 + 0,04(4\bar{\lambda})^{(0,5-\bar{\lambda})} - 0,22\bar{\lambda}^{1,4(1-\bar{\lambda})}$ <p>if $\bar{\lambda} > 0,2$</p>

Table 6.6 - Values of α and $\bar{\lambda}_0$ for flexural buckling

Material buckling class according to Table 3.2	α	$\bar{\lambda}_0$
Class A	0,20	0,10
Class B	0,32	0,00

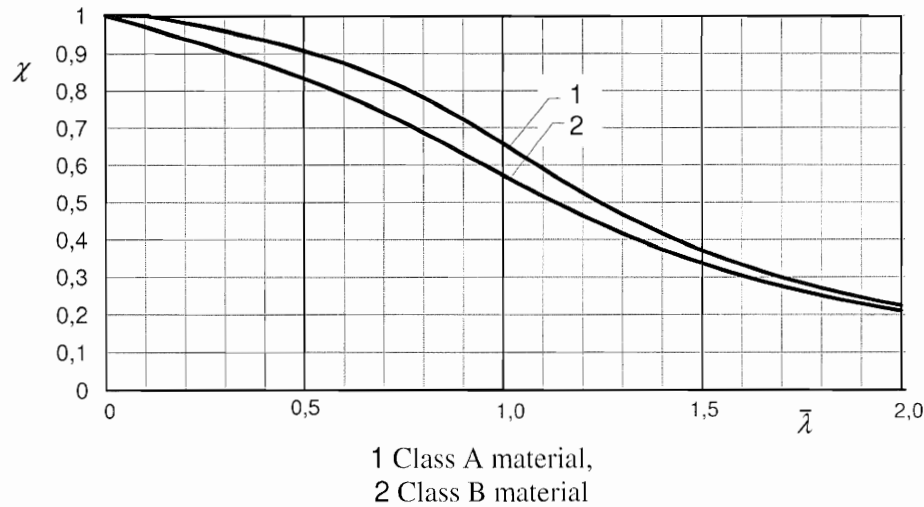

Figure 6.11 - Reduction factor χ for flexural buckling

Table 6.7 - Values of α , $\bar{\lambda}_0$ and A_{eff} for torsional and torsional-flexural buckling

Cross-section	α	$\bar{\lambda}_0$	A_{eff}
General ¹⁾	0,35	0,4	A_{eff} ¹⁾
Composed entirely of radiating outstands ²⁾	0,20	0,6	A ²⁾

1) For sections containing reinforced outstands such that mode 1 would be critical in terms of local buckling (see 6.1.4.3(2)), the member should be regarded as "general" and A_{eff} determined allowing for either or both local buckling and HAZ material.

2) For sections such as angles, tees and cruciforms, composed entirely of radiating outstands, local and torsional buckling are closely related. When determining A_{eff} allowance should be made, where appropriate, for the presence of HAZ material but no reduction should be made for local buckling i.e. $\rho_c = 1$.

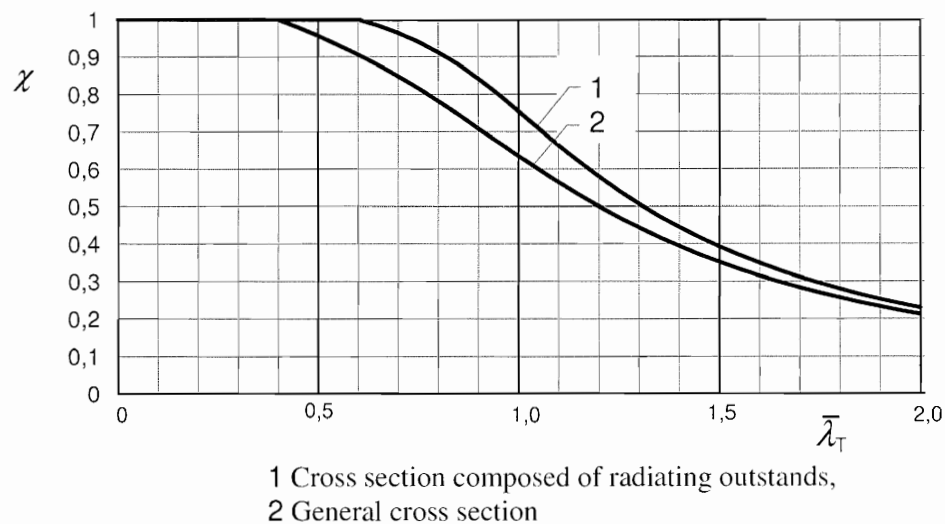

Figure 6.12 - Reduction factor χ for torsional and torsional-flexural buckling

6.3.1.3 Slenderness for flexural buckling

Ⓐ) (1) The relative slenderness $\bar{\lambda}$ is given by:

$$\bar{\lambda} = \sqrt{\frac{A_{eff} f_0}{N_{cr}}} = \frac{L_{cr}}{i} \frac{1}{\pi} \sqrt{\frac{A_{eff} f_0}{A E}} \quad (6.52)$$

where:

L_{cr} is the buckling length in the buckling plane considered Ⓐ)

i is the radius of gyration about the relevant axis, determined using the properties of gross cross-section.

(2) The buckling length L_{cr} should be taken as kL , where L is the length between points of lateral support; for a cantilever, L is its length. The value of k , the buckling length factor for members, should be assessed from knowledge of the end conditions. Unless more accurate analysis is carried out, Table 6.8 should be used.

NOTE The buckling length factors k are increased compared to the theoretical value for fixed ends to allow for various deformations in the connection between different structural parts.

Table 6.8 - Buckling length factor k for members

End conditions	k
1. Held in position and restrained in direction at both ends	0,7
2. Held in position at both ends and restrained in direction at one end	0,85
3. Held in position at both ends, but not restrained in direction	1,0
4. Held in position at one end, and restrained in direction at both ends	1,25
5. Held in position and restrained in direction at one end, and partially restrained in direction but not held in position at the other end	1,5
6. Held in position and restrained in direction at one end, but not held in position or restrained at the other end	2,1

A1

6.3.1.4 Slenderness for torsional and torsional-flexural buckling

(1) For members with open cross-sections account should be taken of the possibility that the resistance of the member to either torsional or torsional-flexural buckling could be less than its resistance to flexural buckling

NOTE The possibility of torsional and torsional-flexural buckling may be ignored for the following:

- a) hollow sections
- b) doubly symmetrical I-sections
- c) sections composed entirely of radiating outstands, e.g. angles, tees, cruciforms, that are classified as class 1 and 2 in accordance with 6.1.4

(2) The relative slenderness $\bar{\lambda} = \bar{\lambda}_T$ for torsional and torsional-flexural buckling should be taken as:

$$\bar{\lambda}_T = \sqrt{\frac{A_{eff} f_o}{N_{cr}}} \tag{6.53}$$

where:

- A_{eff} is the cross-section area according to Table 6.7
- N_{cr} is the elastic critical load for torsional buckling, allowing for interaction with flexural buckling if necessary (torsional-flexural buckling)

NOTE Values of N_{cr} and $\bar{\lambda}_T$ are given in Annex I.

6.3.1.5 Eccentrically connected single - bay struts

(1) Providing the end attachment prevents rotation in the plane of the connected part and no deliberate bending is applied, the following types of eccentrically connected strut may be designed using a simplified approach. This represents an alternative to the general method for combined bending and compression of 6.3.3:

- a) single angle connected through one leg only;
- b) back to back angles connected to one side of a gusset plate;
- c) single channel connected by its web only;
- d) A1 single A1 tee connected by its flange only.

(2) Where flexural buckling using 6.3.1.1 out of the plane of the attached part(s) is checked, the eccentricity of loading should be ignored and the value of $N_{b,Rd}$ should be taken as 40% of the value for centroidal loading.

(3) The value for a) should be that about the axis parallel to the connected part(s). For torsional buckling no change to the method of 6.3.1.1 and 6.3.1.4 is necessary.

6.3.2 Members in bending

(1) The following resistances should normally be checked:

- a) bending (see 6.2.5), including, where appropriate, allowance for coincident shear (see 6.2.8);
- b) shear (see 6.2.6 and 6.2.8);
- c) web bearing (see 6.7.5);
- d) lateral torsional buckling (see 6.3.2.1).

(2) Due account should be taken of the class of cross-section (see 6.1.4), the presence of any heat affected zones (see 6.1.5) and the need to allow for the presence of holes (see 6.2.5).

(3) For members required to resist bending combined with axial load reference is made to 6.3.3.

(4) Biaxial bending combined with axial load is covered under 6.2.9 and 6.3.3. If there is no axial force the term with N_{Ed} should be deleted.

6.3.2.1 Buckling resistance

NOTE Lateral torsional buckling need not be checked in any of the following circumstances:

- a) bending takes place about the minor principal axis and at the same time the load application is not over the shear centre;
- b) the member is fully restrained against lateral movement throughout its length;
- c) the relative slenderness $\bar{\lambda}_{LT}$ (see 6.3.2.3) between points of effective lateral restraint is less than 0.4.

(1)P A laterally unrestrained member subject to $\langle A_1 \rangle$ major $\langle A_1 \rangle$ axis bending shall be verified against lateral-torsional buckling as follows:

$$\frac{M_{Ed}}{M_{b,Rd}} \leq 1,0 \quad (6.54)$$

where:

- M_{Ed} is the design value of the bending moment
- $M_{b,Rd}$ is the design buckling resistance moment.

(2) The design buckling resistance moment of laterally un-restrained member should be taken as:

$$M_{b,Rd} = \chi_{LT} \alpha W_{el,y} f_o / \gamma_{M1} \quad (6.55)$$

where:

- $W_{el,y}$ is the elastic section modulus of the gross section, without reduction for HAZ softening, local buckling or holes.
- α is taken from Table 6.4 subject to the limitation $\alpha \leq W_{pl,y} / W_{el,y}$.
- χ_{LT} is the reduction factor for lateral torsional buckling (see 6.3.2.2).

6.3.2.2 Reduction factor for lateral torsional buckling

(1) The reduction factor for lateral torsional buckling χ_{LT} for the appropriate relative slenderness $\bar{\lambda}_{LT}$ should be determined from:

$$\chi_{LT} = \frac{1}{\phi_{LT} + \sqrt{\phi_{LT}^2 - \bar{\lambda}_{LT}^2}} \quad \text{but } \chi_{LT} \leq 1 \quad (6.56)$$

where:

$$\phi_{LT} = 0,5 \left[1 + \alpha_{LT} (\bar{\lambda}_{LT} - \bar{\lambda}_{0,LT}) + \bar{\lambda}_{LT}^2 \right] \quad (6.57)$$

α_{LT} is an imperfection factor

$\bar{\lambda}_{LT}$ is the relative slenderness

$\bar{\lambda}_{0,LT}$ is the limit of the horizontal plateau

M_{cr} is the elastic critical moment for lateral-torsional buckling.

(2) The value of α_{LT} and $\bar{\lambda}_{0,LT}$ should be taken as:

$\alpha_{LT} = 0,10$ and $\bar{\lambda}_{0,LT} = 0,6$ for class 1 and 2 cross-sections

$\alpha_{LT} = 0,20$ and $\bar{\lambda}_{0,LT} = 0,4$ for class 3 and 4 cross-sections.

(3) Values of the reduction factor χ_{LT} for the appropriate relative slenderness $\bar{\lambda}_{LT}$ may be obtained from Figure 6.13

(4) For slenderness $\bar{\lambda}_{LT} \leq \bar{\lambda}_{0,LT}$ or for $M_{Ed} \leq \lambda_{0,LT}^2 M_{cr}$ the buckling effects may be ignored and only cross-sectional check apply.

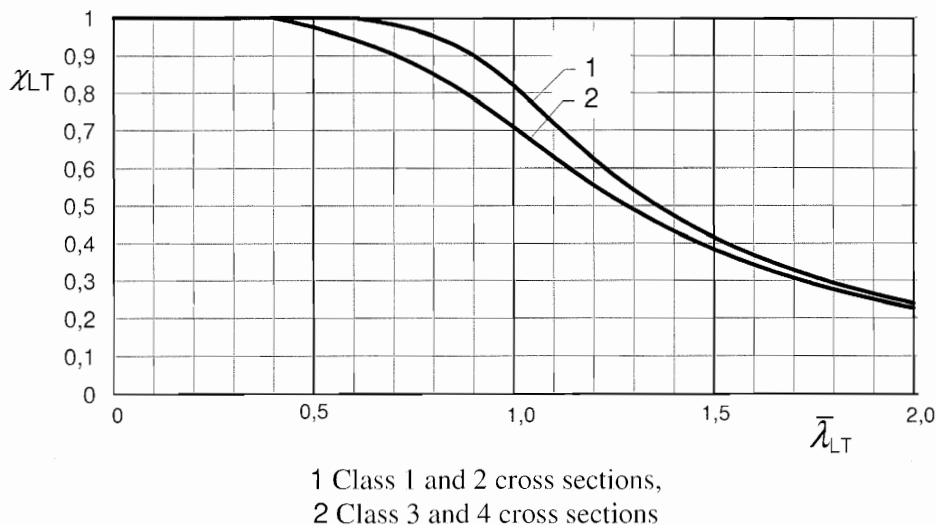

Figure 6.13 - Reduction factor for lateral-torsional buckling

6.3.2.3 Slenderness

(1) The relative slenderness parameter $\bar{\lambda}_{LT}$ should be determined from

$$\bar{\lambda}_{LT} = \sqrt{\frac{\alpha W_{el,y} f_o}{M_{cr}}} \quad (6.58)$$

where:

α is taken from Table 6.4 subject to the limitation $\alpha \leq W_{pl,y} / W_{el,y}$.

M_{cr} is the elastic critical moment for lateral-torsional buckling.

(2) M_{cr} is based on gross cross sectional properties and takes into account the loading conditions, the real moment distribution and the lateral restraints.

NOTE Expressions for M_{cr} for certain sections and boundary conditions are given in Annex I.1 and approximate values of $\bar{\lambda}_{LT}$ for certain I-sections and channels are given in Annex I.2.

6.3.2.4 Effective Lateral Restraints

(1) Bracing systems providing lateral restraint should be designed according to 5.3.3.

NOTE Where a series of two or more parallel members require lateral restraint, it is not adequate merely to tie the compression flanges together so that they become mutually dependent. Adequate restraint will be provided only by anchoring the ties to an independent robust support, or by providing a triangulated bracing system. If the number of parallel members exceeds three, it is sufficient for the restraint system to be designed to resist the sum of the lateral forces derived from the three largest compressive forces only.

6.3.3 Members in bending and axial compression

(1) Unless second order analysis is carried out using the imperfections as given in 5.3.2, the stability of uniform members should be checked as given in the following clause, where a distinction is made for:

- members that are not susceptible to torsional deformations, e.g. circular hollow sections or sections restrained from torsion (flexural buckling only);
- members that are susceptible to torsional deformations, e.g. members with open cross-sections not restrained from torsion (lateral-torsional buckling or flexural buckling).

(2) Two checks are in general needed for members that are susceptible to torsional deformations:

- flexural buckling;
- lateral-torsional buckling.

(3) For calculation of the resistance N_{Rd} , $M_{y,Rd}$ and $M_{z,Rd}$ due account of the presence of HAZ-softening from longitudinal welds should be taken. (See 6.2.4 and 6.2.5). The presence of localized HAZ-softening from transverse welds and the presence of holes should be taken care of according to 6.3.3.3 and 6.3.3.4 respectively.

(4) All quantities in the interaction criterion should be taken as positive.

NOTE 1 Classification of cross-sections for members with combined bending and axial forces is made for the loading components separately according to 6.1.4. No classification is made for the combined state of stress.

NOTE 2 A cross-section can belong to different classes for axial force, major axis bending and minor axis bending. The combined state of stress is taken care of in the interaction expressions. These interaction expressions can be used for all classes of cross-section. The influence of local buckling and yielding on the resistance for combined loading is taken care of by the capacities in the denominators and the exponents, which are functions of the slenderness of the cross-section.

NOTE 3 Section check is included in the check of flexural and lateral-torsional buckling if the methods in 6.3.3.1 and 6.3.3.5 are used.

6.3.3.1 Flexural buckling

(1) For a member with open doubly symmetric cross-section (solid sections, see (2)), one of the following criteria should be satisfied:

- For major axis (y-axis) bending:

$$\left(\frac{N_{Ed}}{\chi_y \omega_x N_{Rd}} \right)^{\xi_{yc}} + \frac{M_{y,Ed}}{\omega_0 M_{y,Rd}} \leq 1,00 \quad (6.59)$$

- For minor axis (z-axis) bending:

$$\left(\frac{N_{Ed}}{\chi_z \omega_x N_{Rd}} \right)^{\eta_c} + \left(\frac{M_{z,Ed}}{\omega_0 M_{z,Rd}} \right)^{\xi_{zc}} \leq 1,00 \quad (6.60)$$

where:

$$\eta_c = 0,8 \text{ or may alternatively be taken as } \eta_c = \eta_0 \chi_z \text{ but } \eta_c \geq 0,8 \quad (6.61a)$$

$$\xi_{yc} = 0,8 \text{ or may alternatively be taken as } \xi_{yc} = \xi_0 \chi_y \text{ but } \xi_{yc} \geq 0,8 \quad (6.61b)$$

$$\xi_{zc} = 0,8 \text{ or may alternatively be taken as } \xi_{zc} = \xi_0 \chi_z \text{ but } \xi_{zc} \geq 0,8 \quad (6.61c)$$

η_0 and ξ_0 are according to 6.2.9.1

$\omega_x = \omega_0 = 1$ for beam-columns without localized welds and with equal end moments. $\text{\textcircled{A1}}$ Otherwise, see 6.3.3.3, 6.3.3.4 and 6.3.3.5 $\text{\textcircled{A1}}$, respectively.

(2) For solid cross-sections criterion (6.60) may be used with the exponents taken as 0,8 or

$$\eta_c = 2\chi \quad \text{but } \eta_c \geq 0,8 \quad (6.61d)$$

$$\xi_c = 1,56\chi \quad \text{but } \xi_c \geq 0,8 \quad (6.61e)$$

(3) Hollow cross-sections and tubes should satisfy the following criterion:

$$\left(\frac{N_{Ed}}{\chi_{\min} \omega_x N_{Rd}} \right)^{\psi_c} + \frac{1}{\omega_0} \left[\left(\frac{M_{y,Ed}}{M_{y,Rd}} \right)^{1,7} + \left(\frac{M_{z,Ed}}{M_{z,Rd}} \right)^{1,7} \right]^{0,6} \leq 1,00 \quad (6.62)$$

where $\psi_c = 0,8$ or may alternatively be taken as $1,3\chi_y$ or $1,3\chi_z$ depending on direction of buckling, but $\psi_c \geq 0,8$. $\chi_{\min} = \min(\chi_y, \chi_z)$

(4) For other open monosymmetrical cross sections, bending about either axis, expression (6.59) may be used with ξ_{yc} , $M_{y,Ed}$, $M_{y,Rd}$ and χ_y replaced by ξ_{zc} , $M_{z,Ed}$, $M_{z,Rd}$ and χ_z

(5) The notations in the criteria (6.59) to (6.62) are:

N_{Ed} is the design value of the axial compressive force

$M_{y,Ed}$, $M_{z,Ed}$ are the design values of bending moment about the y- and z-axis. The moments are calculated according to *first order theory*

$N_{Rd} = Af_o / \gamma_{M1}$ or $A_{\text{eff}} f_o / \gamma_{M1}$ for class 4 cross-sections. For members with longitudinal welds but without localized welds $N_{Rd} = \kappa Af_o / \gamma_{M1}$ or $\kappa A_{\text{eff}} f_o / \gamma_{M1}$, see 6.3.1.

χ_y and χ_z are the reduction factor for buckling in the z-x plane and the y-x plane, respectively

$M_{y,Rd} = \alpha_y W_y f_o / \gamma_{M1}$ bending moment capacity about the y-axis

$M_{z,Rd} = \alpha_z W_z f_o / \gamma_{M1}$ bending moment capacity about the z-axis

α_y , α_z are the shape factors, but α_y and α_z should not be taken larger than 1,25. See 6.2.5 and 6.2.9.1(1)

6.3.3.2 Lateral-torsional buckling

(1) Members with open cross-section symmetrical about major axis, centrally symmetric or doubly symmetric cross-section, the following criterion should satisfy:

$$\left(\frac{N_{Ed}}{\chi_z \omega_x N_{Rd}} \right)^{\eta_c} + \left(\frac{M_{y,Ed}}{\chi_{LT} \omega_{xLT} M_{y,Rd}} \right)^{\gamma_c} + \left(\frac{M_{z,Ed}}{\omega_0 M_{z,Rd}} \right)^{\xi_{zc}} \leq 1,00 \quad (6.63)$$

where:

N_{Ed} is the design value of axial compression force

$M_{y,Ed}$ is bending moment about the y-axis. In the case of beam-columns with hinged ends and in the case of members in non-sway frames, $M_{y,Ed}$ is moment of the *first order*. For members in frames free to sway, $M_{y,Ed}$ is bending moment according to *second order theory*.

$M_{z,Ed}$ is bending moment about the z-axis. $M_{z,Ed}$ is bending moment according to *first order theory*

$N_{Rd} = Af_o / \gamma_{M1}$ or $A_{\text{eff}} f_o / \gamma_{M1}$ for class 4 cross-sections. For members with longitudinal welds but without localized welds $N_{Rd} = \kappa Af_o / \gamma_{M1}$ or $\kappa A_{\text{eff}} f_o / \gamma_{M1}$, see 6.3.1.

χ_z is the reduction factor for buckling when one or both flanges deflects laterally (buckling in the x-y plane or lateral-torsional buckling) based on (6.68a) in section with localized weld

$M_{y,Rd} = \alpha_y W_{y,el} f_o / \gamma_{M1}$ = bending moment capacity for y-axis bending

$M_{z,Rd} = \alpha_z W_{z,el} f_o / \gamma_{M1}$ = bending moment capacity for z-axis bending

α_y, α_z are the shape factors but α_y and α_z should not be taken larger than 1,25. See 6.2.5 and 6.2.9.1(1)

χ_{LT} is the reduction factor for lateral-torsional buckling

$\eta_c = 0,8$ or alternatively $\eta_0 \chi_z$ but $\eta_c \geq 0,8$

$\gamma_c = \gamma_0$

$\xi_{zc} = 0,8$ or alternatively $\xi_0 \chi_z$ but $\xi_{zc} \geq 0,8$

where η_0, γ_0 and ξ_0 are defined according to the expression in 6.2.9.1.

ω_x, ω_0 and ω_{xLT} = HAZ-softening factors, see 6.3.3.3 or factors for design section, see 6.3.3.5.

(2) The criterion for flexural buckling, see 6.3.3.1, should also be satisfied.

6.3.3.3 Members containing localized welds

(1) The value of ω_x, ω_0 and ω_{xLT} for a member subject to HAZ softening, should generally be based on the *ultimate* strength of the HAZ softened material. It could be referred to the most unfavourable section in the bay considered. If such softening occurs only locally along the length, then ω_x, ω_0 and ω_{xLT} in the expressions in 6.3.3.1 and 6.3.3.2 are:

$$\omega_0 = \omega_x = \omega_{xLT} = \frac{\rho_{u,haz} f_u / \gamma_{M2}}{f_o / \gamma_{M1}} \quad \text{but } \leq 1,00 \quad (6.64)$$

where $\rho_{u,haz}$ is the reduction factor for the heat affected material according to 6.1.6.2.

(2) However, if HAZ softening occurs close to the ends of the bay, or close to points of contra flexure only, ω_x and ω_{xLT} may be increased in considering flexural and lateral-torsional buckling, provided that such softening does not extend a distance along the member greater than the least width (e.g. flange width) of the section.

$$\omega_x = \frac{\omega_0}{\chi + (1 - \chi) \sin \frac{\pi x_s}{l_c}} \quad (6.65)$$

$$\omega_{xLT} = \frac{\omega_0}{\chi_{LT} + (1 - \chi_{LT}) \sin \frac{\pi x_s}{l_c}} \quad (6.66)$$

$$\omega_0 = \frac{\rho_{u,haz} f_u / \gamma_{M2}}{f_o / \gamma_{M1}} \quad \text{but } \omega_0 \leq 1,00 \quad (6.67)$$

where:

$\chi = \chi_y$ or χ_z depending on buckling direction

χ_{LT} is the reduction factor for lateral-torsional buckling of the beam-column in bending only

x_s is the distance from the localized weld to a support or point of contra flexure for the deflection curve for elastic buckling of axial force only, compare Figure 6.14.

l_c is the buckling length.

(3) Calculation of χ (χ_y or χ_z) and χ_{LT} in the section with the localized weld should be based on the ultimate strength of the heat affected material for the relative slenderness parameters

$$\bar{\lambda}_{haz} = \bar{\lambda} \sqrt{\omega_0} \quad (6.68a)$$

$$\bar{\lambda}_{\text{haz,LT}} = \bar{\lambda}_{LT} \sqrt{\omega_0} \tag{6.68b}$$

(4) If the length of the softening region is larger than the least width (e.g. flange width) of the section, then the factor $\rho_{u,\text{haz}}$ for local failure in the expressions for ω_x , ω_{xLT} , $\bar{\lambda}_{\text{haz}}$, $\bar{\lambda}_{\text{haz,LT}}$ should be replaced by the factor $\rho_{o,\text{haz}}$ for overall yielding.

(5) If the localized softening region covers a part of the cross-section (e.g. one flange) then the whole cross-section is supposed to be softened.

6.3.3.4 Members containing localized reduction of cross-section

(1) Members containing localized reduction of cross-section, e.g. bolt holes or flange cut-outs, should be checked according to 6.3.3.3 by replacing $\rho_{u,\text{haz}}$ in ω_x and ω_{xLT} with A_{net}/A_g where A_{net} is net section area, with reduction of holes and A_g gross section area.

6.3.3.5 Unequal end moments and/or transverse loads

(1) For members subjected to combined axial force and unequal end moments and/or transverse loads, different sections along the beam-column should be checked. The actual bending moment in the studied section is used in the interaction expressions. ω_x and ω_{xLT} should be:

$$\omega_x = \frac{1}{\chi + (1 - \chi) \sin \frac{\pi x_s}{l_c}} \tag{6.69}$$

$$\omega_{xLT} = \frac{1}{\chi_{LT} + (1 - \chi_{LT}) \sin \frac{\pi x_s}{l_c}} \tag{6.70}$$

where x_s is the distance from the studied section to a simple support or point of contra flexure of the deflection curve for elastic buckling of axial force only, see Figure 6.14.

Ⓐ) (2) For end moments $M_{\text{Ed},1} > M_{\text{Ed},2}$ only, the distance x_s can be calculated from

$$\cos\left(\frac{x_s \pi}{l_c}\right) = \frac{(M_{\text{Ed},1} - M_{\text{Ed},2})}{M_{\text{Rd}}} \cdot \frac{N_{\text{Rd}}}{N_{\text{Ed}}} \cdot \frac{1}{\pi(1/\chi - 1)} \text{ but } x_s \geq 0 \tag{6.71}$$

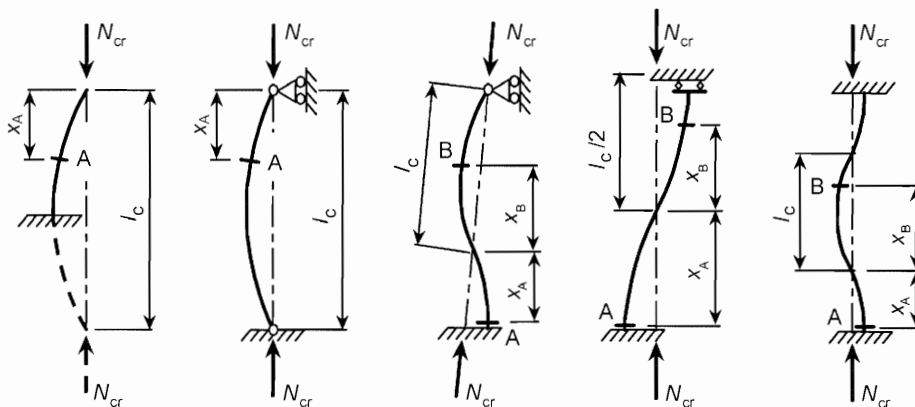

A and B are examples of studied sections marked with transverse lines.

See Table 6.8 for value of buckling length $l_c = KL$.

Figure 6.14 - Buckling length l_c and definition of x_s ($= x_A$ or x_B) Ⓐ

6.4 Uniform built-up members

6.4.1 General

(1) Uniform built-up compression members with hinged ends that are laterally supported should be designed with the following model, see Figure 6.15.

1. The member may be considered as a column with a bow imperfection $e_0 = L / 500$
2. The elastic deformations of lacings or battening, see Figure 6.15, may be considered by continuous (smeared) shear stiffness S_v of the column.

NOTE For other end conditions appropriate modifications may be performed.

(2) The model of a uniform built-up compression member applies if:

1. the lacings or battening consist of equal modules with parallel chords;
2. the minimum number of modules in a member is three.

NOTE This assumption allows the structure to be regular and smearing the discrete structure to a continuum.

(3) The design procedure is applicable to built-up members with lacings in two directions, see Figure 6.16.

(4) The chords may be solid members or may themselves be laced or battened in the perpendicular plane.

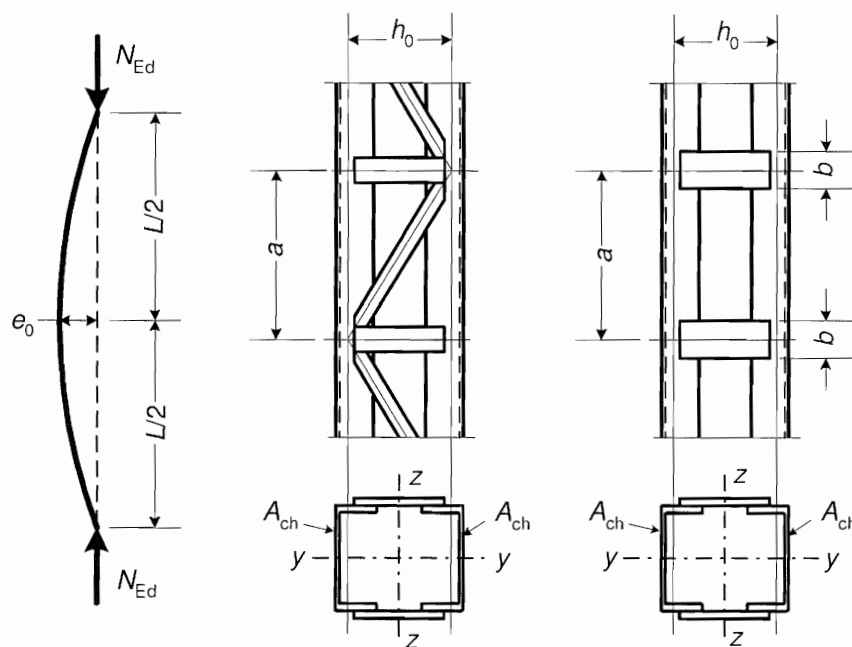

Figure 6.15 - Uniform built-up columns with lacings and battening

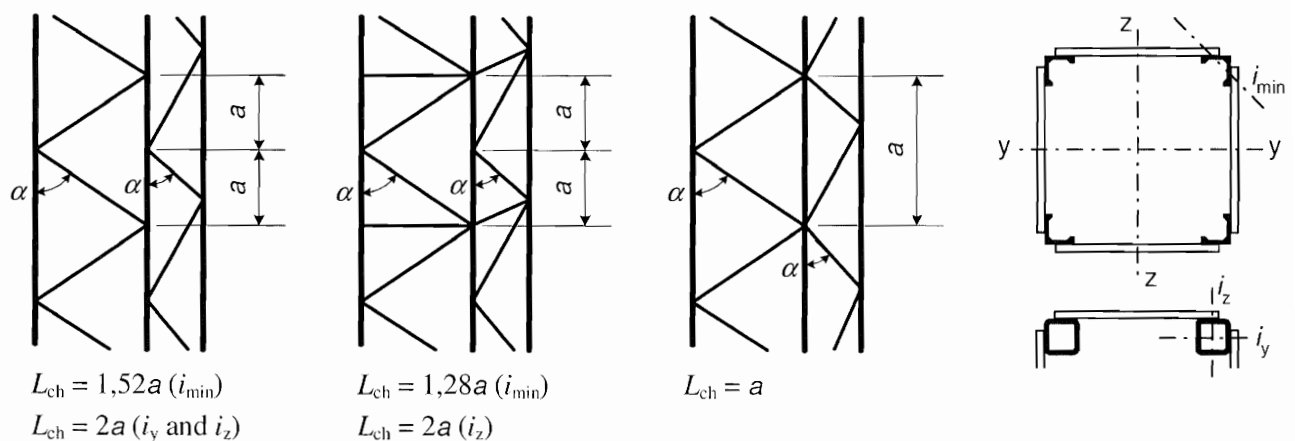

Figure 6.16 - Lacings on four sides and buckling length L_{ch} of chords

(5) Checks should be performed for chords using the design chord forces $N_{ch,Ed}$ from compression forces N_{Ed} and moments M_{Ed} at mid span of the built-up member.

(6) For a member with two identical chords the design force $N_{ch,Ed}$ should be determined from:

$$N_{ch,Ed} = 0,5N_{Ed} + \frac{M_{Ed}h_0A_{ch}}{2I_{eff}} \quad (6.72)$$

where:

$$M_{Ed} = \frac{N_{Ed}e_0 + M_{Ed}^I}{1 - \frac{N_{Ed}}{N_{cr}} - \frac{N_{Ed}}{S_v}}$$

$N_{cr} = \pi^2 EI_{eff} / L^2$ is the critical force of the effective built-up member

N_{Ed} is the design value of the compression force to the built-up member

M_{Ed} is the design value of the maximum moment in the middle of the built-up member considering second order effects

M_{Ed}^I is the design value of the maximum moment in the middle of the built-up member without second order effects

h_0 is the distance between the centroids of chords

A_{ch} is the cross-sectional area of one chord

I_{eff} is the effective second moment of area of the built-up member, see 6.4.2 and 6.4.3

S_v is the shear stiffness of the lacings or battened panel, see 6.4.2 and 6.4.3

(7) The checks for the lacings of laced built-up members or for the frame moments and shear forces of the battened panels of battened built-up members should be performed for the end panel taking account of the shear force in the built-up member:

$$V_{Ed} = \pi \frac{M_{Ed}}{L} \quad (6.73)$$

6.4.2 Laced compression members

6.4.2.1 Resistance of components of laced compression members

(1) The chords and diagonal lacings subject to compression should be designed for buckling.

NOTE Secondary moments may be neglected.

(2)P For chords the buckling verification shall be performed as follows:

$$\frac{N_{ch,Ed}}{N_{b,Rd}} \leq 1,0 \quad (6.74)$$

where:

$N_{ch,Ed}$ is the design compression force in the chord at mid-length of the built-up member according to 6.4.1(6)

$N_{b,Rd}$ is the design value of the buckling resistance of the chord taking the buckling length L_{ch} from Figure 6.16.

(3) The shear stiffness S_y of the lacings should be taken from Figure 6.17.

(4) The effective second order moment of area of laced built-up members may be taken from (6.77) with $\mu = 0$. Then :

$$I_{eff} = 0,5h_0^2 A_{ch} \quad (6.75)$$

System			
S_v	$\frac{nEA_d a h_0^2}{2d^3}$	$\frac{nEA_d a h_0^2}{d^3}$	$\frac{nEA_d a h_0^2}{d^3 \left(1 + \frac{A_d h_0^3}{A_v d^3} \right)}$
<p>n is number of planes of lacings A_d and A_v refer to the cross sectional area of the bracings in one plane</p>			

Figure 6.17 - Shear stiffness of lacings of built-up members

6.4.2.2 Constructional details

- (1) Single lacing system in opposite faces of the built-up members with two parallel laced planes should be corresponding systems as shown in Figure 6.18(a), arranged so that one is shadow of the other.
- (2) If the single lacing systems on opposite faces of a built-up member with two parallel laced planes are mutually opposed in direction as shown in Figure 6.18(b), the resulting torsional effects in the member should be taken into account.
- (3) Tie panels should be provided at the ends of lacing systems, at points where the lacing is interrupted and at joints with other members.

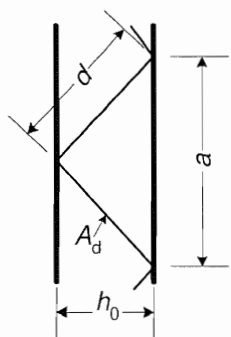
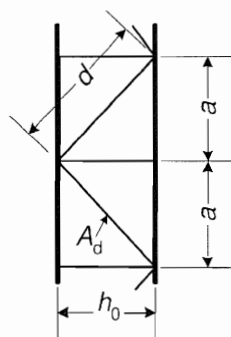
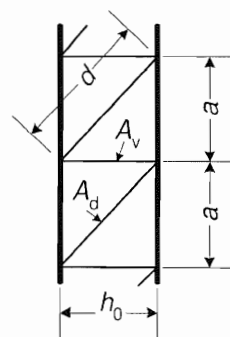
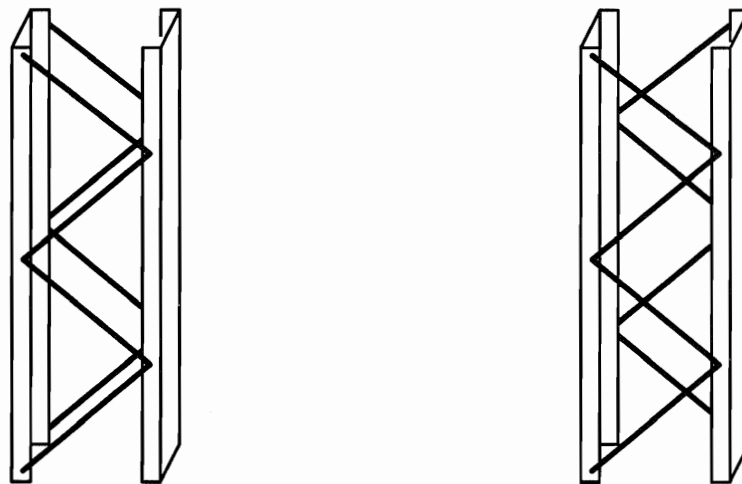

a) Corresponding lacing system
(recommended system)

b) Mutually opposed lacing system
(not recommended)

Figure 6.18 - Single lacing system on opposite faces of a built-up member with two parallel laced planes

6.4.3 Battened compression members

6.4.3.1 Resistance of components of battened compression members

- (1) The chords and the battens and their joints to the chords should be checked for the actual moments and forces in an end panel and at mid-span as indicated in Figure 6.19.

NOTE For simplicity the maximum chord forces $N_{ch,Ed}$ may be combined with the maximum shear force V_{Ed} .

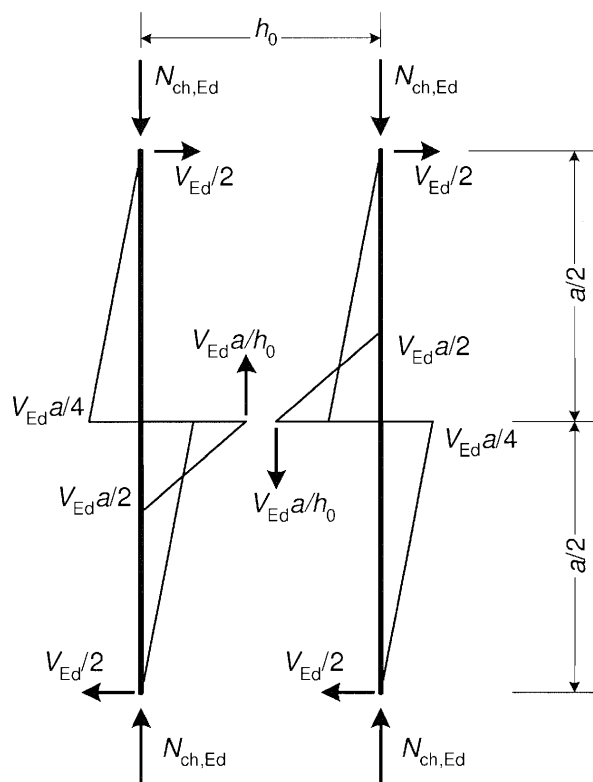

Figure 6.19 - Moments and forces in an end panel of a battened built-up member

(2) The shear stiffness S_v should be taken as follows:

$$S_v = \frac{24EI_{ch}}{a^2 \left(1 + \frac{2I_{ch} h_0}{nI_b a} \right)} \leq \frac{2\pi^2 EI_{ch}}{a^2} \quad (6.76)$$

(1) The effective second moment of area of battened built-up members may be taken as:

$$I_{eff} = 0,5h_0^2 A_{ch} + 2\mu I_{ch} \quad (6.77)$$

where:

I_{ch} is in plane second moment of area of one chord

I_b is in plane second moment of area of one batten

μ is efficiency factor from Table 6.9

Table 6.9 - Efficiency factor μ

criteria	efficiency factor μ
$\lambda \geq 150$	0
$75 < \lambda < 150$	$\mu = 2 - \lambda/75$
$\lambda \leq 150$	1,0

where $\lambda = \frac{L}{i_0}$; $i_0 = \sqrt{\frac{I_1}{2A_{ch}}}$; $I_1 = 0,5h_0^2 A_{ch} + 2I_{ch}$

6.4.3.2 Constructional details

- (1) Battens should be provided at each end of a member.
- (2) Where parallel planes of battens are provided, the battens in each plane should be arranged opposite each other.
- (3) Battens should also be provided at intermediate points where loads are applied or lateral restraint is supplied.

6.4.4 Closely spaced built-up members

(1) Built-up compression members with chords in contact or closely spaced and connected through packing plates, see Figure 6.20, or star batted angle members connected by pairs of battens in two perpendicular planes, see Figure 6.21 should be checked for buckling as a single integral member ignoring the effect of shear stiffness ($S_v = \infty$), if the conditions in Table 6.10 are met.

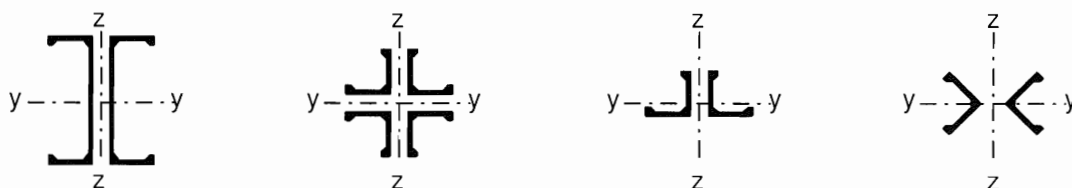

Figure 6.20 - Closely spaced built-up members

Table 6.10 - Maximum spacing for interconnections in closely spaced built-up or star batted angle members

Type of built-up member	Maximum spacing between interconnections *)
Members according to Figure 6.20 in contact or connected through packings by bolts or welds	$15i_{min}$
Members according to Figure 6.21 connected by pair of battens and by bolts or welds	$70i_{min}$
*) centre-to-centre distance of interconnections i_{min} is the minimum radius of gyration of one chord or one angle	

- (2) The shear forces to be transmitted by the battens should be determined from 6.4.3.1(1).
- (3) In the case of unequal-leg angles, see Figure 6.21, buckling about the y-y axis may be verified with:

$$i_y \cong 0,87 i_0 \tag{6.78}$$

where i_0 is the radius of gyration of the built-up member about the 0-0 axis.

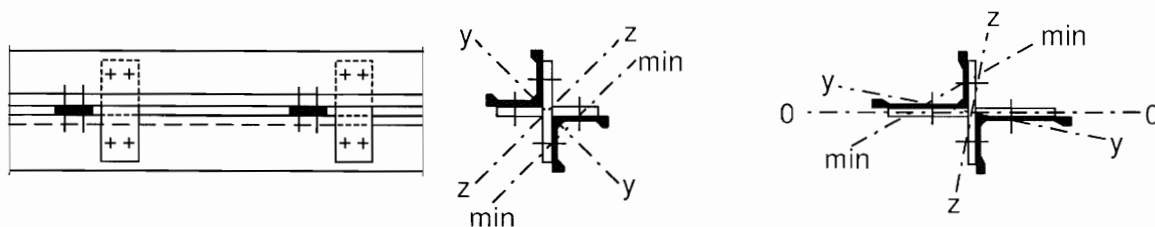

Figure 6.21 - Star-batted angle members

6.5 Un-stiffened plates under in-plane loading

6.5.1 General

(1) In certain types of structure un-stiffened plates can exist as separate components under direct stress, shear stress, or a combination of the two. The plates are attached to the supporting structure by welding, riveting,

bolting or bonding, and the form of attachment can affect the boundary conditions. Thin plates must be checked for the ultimate limit states of bending under lateral loading, buckling under edge stresses in the plane of the plate, and for combinations of bending and buckling. The design rules given in this section only refer to rectangular plates. For slender beam webs, see 6.7.

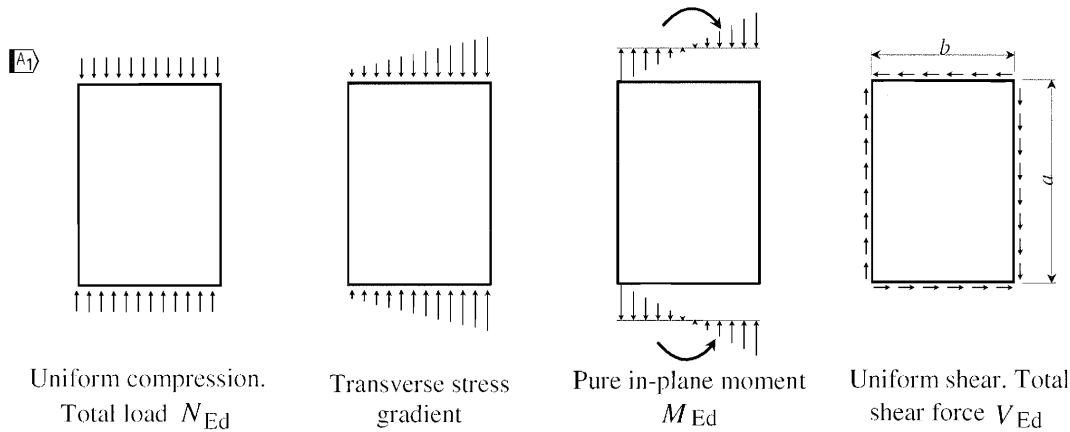

Figure 6.22 - Unstiffened plates \square

6.5.2 Resistance under uniform compression

(1) A rectangular plate under uniform end compression is shown in Figure 6.22. The length of the plate in the direction of compression = a , and the width across the plate = b . The thickness is assumed to be uniform, and equal to t . The plate can be supported on all four edges, where the support conditions are hinged, elastically restrained or fixed, or it can be free along one longitudinal edge.

(2) The susceptibility of the unstiffened plate to buckling is defined by the parameter β , where $\beta = b/t$. The classification of the cross-section is carried out in the same way as that described in 6.1.4, where plates with longitudinal edges simply supported, elastically restrained, or completely fixed are taken to correspond to “internal parts”, and plates with one longitudinal edge free correspond to “outstands”. Thus

$$\begin{aligned} \beta &\leq \beta_2 && \text{class 1 or 2} \\ \beta_2 &\leq \beta < \beta_3 && \text{class 3} \\ \beta_3 &< \beta && \text{class 4} \end{aligned}$$

where values of β_2 and β_3 are given in Table 6.2.

(3)P The design value of the compression force N_{Ed} shall satisfy

$$\frac{N_{Ed}}{N_{Rd}} \leq 1,0 \quad (6.79)$$

where N_{Rd} is the lesser of

$$N_{o,Rd} = A_{eff} f_o / \gamma_{M1} \quad (\text{overall yielding and local buckling}) \quad \text{and} \quad (6.80)$$

$$N_{u,Rd} = A_{net} f_u / \gamma_{M2} \quad (\text{local failure}) \quad (6.81)$$

where:

A_{eff} is the effective area of the cross-section taking account of local buckling for class 4 cross-sections and HAZ softening of longitudinal welds

A_{net} is the area of the least favourable cross-section taking account of unfilled holes and HAZ softening of transverse or longitudinal welds if necessary

(4) A_{eff} for class 4 cross-section is obtained by taking a reduced thickness to allow for buckling as well as for HAZ softening, but with the presence of holes ignored. A_{eff} is generally based on the least favourable cross-section, taking a thickness equal to the lesser of $\rho_c t$ and $\rho_{o,haz} t$ in HAZ regions, and $\rho_c t$ elsewhere. In this check HAZ softening due to welds at the loaded edges may be ignored.

The factor ρ_c is found from the more favourable of the following treatments:

- Calculate ρ_c from 6.1.5(2) or read from Figure 6.5, using the internal part expressions for plates that are simply supported, elastically restrained, or fixed along longitudinal edges, and the outstand part expressions for plates with one longitudinal free edge.
- Take $\rho_c = \chi$, where χ is the column buckling reduction factor from 6.3.1. In calculating χ take a slenderness parameter $\bar{\lambda}$ equal to $3,5 a/t$, which corresponds to simple support at the loaded edges. For restrained loaded edges a lower value of $\bar{\lambda}$ can be used at the discretion of the designer.

6.5.3 Resistance under in-plane moment

(1) If a pure in-plane moment acts on the ends (width = b) of a rectangular unstiffened plate (see Figure 6.22) the susceptibility to buckling is defined by the parameter β , where $\beta = 0,40 b/t$. The classification of the cross-section is carried out in the same way as described in section 6.5.2.

(2)P The design value of the bending moment M_{Ed} shall satisfy

$$\frac{M_{Ed}}{M_{Rd}} \leq 1,0 \quad (6.82)$$

where the design bending moment resistance M_{Rd} is the lesser of $M_{o,Rd}$ and $M_{u,Rd}$ according to (3) and (4).

(3) The design bending moment resistance $M_{o,Rd}$ for overall yielding and local buckling is as follows:

Class 1 and 2 cross-sections

$$M_{o,Rd} = W_{pl} f_o / \gamma_{M1} \quad (6.83)$$

Class 3 cross-sections

$$M_{o,Rd} = \left[W_{el} + \frac{\beta_3 - \beta}{\beta_3 - \beta_2} (W_{pl} - W_{el}) \right] f_o / \gamma_{M1} \quad (6.84)$$

Class 4 cross-sections

$$M_{o,Rd} = W_{eff} f_o / \gamma_{M1} \quad (6.85)$$

where:

W_{pl} and W_{el} are the plastic and elastic moduli for the gross cross-section or a reduced cross-section to allow for HAZ softening from longitudinal welds, but with the presence of holes ignored

W_{eff} is the elastic modulus for the effective cross-section obtained by taking a reduced thickness to allow for buckling as well as HAZ softening from longitudinal welds if required, but with the presence of holes ignored. See 6.2.5.2.

β is the slenderness factor for the most critical part in the section

β_2 and β_3 are the class 2 and class 3 limiting values of β for that part

~~text deleted~~

(4) The design bending moment resistance $M_{u,Rd}$ for local failure at sections with holes or transverse welds is:

$$M_{u,Rd} = W_{net} f_u / \gamma_{M2} \quad (6.86)$$

where

W_{net} is the section modulus allowing for holes and taking a reduced thickness $\rho_{u,haz} t$ in any region affected by HAZ softening. See 6.2.5.1(2).

6.5.4 Resistance under transverse or longitudinal stress gradient

(1) If the applied actions at the end of a rectangular plate result in a transverse stress gradient, the stresses are transferred into an axial force and a bending moment treated separately according to 6.5.2 and 6.5.3. The load combination is then treated as in 6.5.6.

(2) If the applied compression or in-plane bending moment varies longitudinally along the plate (i.e. in the direction of the dimension a), the design moment resistance for class 1, 2 or 3 cross-sections at any cross-section should not be less than the action arising at that section under factored loading. For class 4 cross-sections the yielding check should be performed at every cross-section, but for the buckling check it is permissible to compare the design compressive or moment resistance with the action arising at a distance from the more heavily loaded end of the plate equal to 0,4 times the elastic plate buckling half wavelength.

6.5.5 Resistance under shear

(1) A rectangular plate under uniform shear forces is shown in Figure 6.22. The thickness is assumed to be uniform and the support conditions along all four edges are either simply supported, elastically restrained or fixed.

(2) The susceptibility to shear buckling is defined by the parameter β , where $\beta = b/t$ and b is the shorter of the side dimensions. For all edge conditions the plate in shear is classified as slender or non-slender as follows:

$$\beta \leq 39\epsilon \quad \text{non-slender plate}$$

$$\beta > 39\epsilon \quad \text{slender plate}$$

where:

$$\epsilon = \sqrt{250 / f_0}, f_0 \text{ in N/mm}^2$$

(3) The design value of the shear force V_{Ed} at each cross-section should satisfy

$$V_{Ed} \leq V_{Rd} \quad (6.87)$$

where V_{Rd} is the design shear resistance of the cross-section based on the least favourable cross-section as follows.

a) non-slender plate ($\beta \leq 39\epsilon$):

$$V_{Rd} = A_{net} f_0 / (\sqrt{3} \gamma_{M1}) \quad (6.88)$$

where A_{net} is the net effective area allowing for holes, and taking a reduced thickness $\rho_{0, haz} t$ in any area affected by HAZ softening. If the HAZ extends around the entire perimeter of the plate the reduced thickness is assumed to extend over the entire cross-section. In allowing for holes, the presence of small holes may be ignored if their total cross-sectional area is less than 20% of the total cross-sectional area bt .

b) slender plate ($\beta > 39\epsilon$):

Values of V_{Rd} for both yielding and buckling should be checked. For the yielding check use a) above for non-slender plates. For the buckling check:

$$V_{Rd} = v_1 b t f_0 / (\sqrt{3} \gamma_{M1}) \quad (6.89)$$

where:

$$v_1 = 17t\epsilon\sqrt{k_\tau} / b \text{ but not more than } v_1 = k_\tau \frac{430t^2\epsilon^2}{b^2} \text{ and } v_1 \leq 1,0$$

$$k_\tau = 5,34 + 4,00(b/a)^2 \text{ if } a/b \geq 1$$

$$k_{\tau} = 4,00 + 5,34(b/a)^2 \quad \text{if } a/b < 1$$

NOTE These expressions do not take advantage of tension field action, but if it is known that the edge supports for the plate are capable of sustaining a tension field, the treatment given in 6.7.3 can be employed.

6.5.6 Resistance under combined action

- (1) A plate subjected to combined axial force and in-plane moment under factored loading should be given a separate classification for the separate actions in accordance with 6.5.2. In so doing, the value of β should be based on the pattern of edge stress produced if the force (N_{Ed}) and the moment (M_{Ed}) act separately.
- (2) If the plate is class 4, each individual resistance, $N_{c,Rd}$ and $M_{o,Rd}$ should be based on the specific type of action considered.
- (3) If the combined action is axial force and in-plane moment, the following condition should be satisfied:

$$\frac{N_{Ed}}{N_{c,Rd}} + \frac{M_{Ed}}{M_{o,Rd}} \leq 1,00 \quad (6.90a)$$

- (4) If the combined action includes the effect of a coincident shear force, V_{Ed} , then V_{Ed} may be ignored if it does not exceed $0,5V_{Rd}$ (see 6.5.8). If $V_{Ed} > 0,5V_{Rd}$ the following condition should be satisfied:

$$\frac{N_{Ed}}{N_{c,Rd}} + \frac{M_{Ed}}{M_{c,Rd}} + \left(\frac{2V_{Ed}}{V_{Rd}} - 1 \right)^2 \leq 1,00 \quad (6.90b)$$

6.6 Stiffened plates under in-plane loading

6.6.1 General

- (1) The following rules concern plates, supported on all four edges and reinforced with one or two, central or eccentric longitudinal stiffeners, or three or more equally spaced longitudinal stiffeners or corrugations (see Figure 6.23). Also general rules for orthotropic plating (Figure 6.23(c), (d) and (e) and clause 6.6.6) are given. Rules for extruded profiles with one or two open stiffeners are given in 6.1.4.3.
- (2) The stiffeners may be unsupported on their whole length or else be continuous over intermediate transverse stiffeners. The dimension L should be taken as the spacing between the supports. An essential feature of the design is that the longitudinal reinforcement, but not transverse stiffening, is "sub-critical", i.e. it can deform with the plating in an overall buckling mode.
- (3) The resistance of such plating to longitudinal direct stress in the direction of the reinforcement is given in 6.6.2 to 6.6.4, and the resistance in shear is given in 6.6.5. Interaction between different effects may be allowed for in the same way as for un-stiffened plates (see 6.7.6). The treatments are valid also if the cross-section contains parts that are classified as slender.

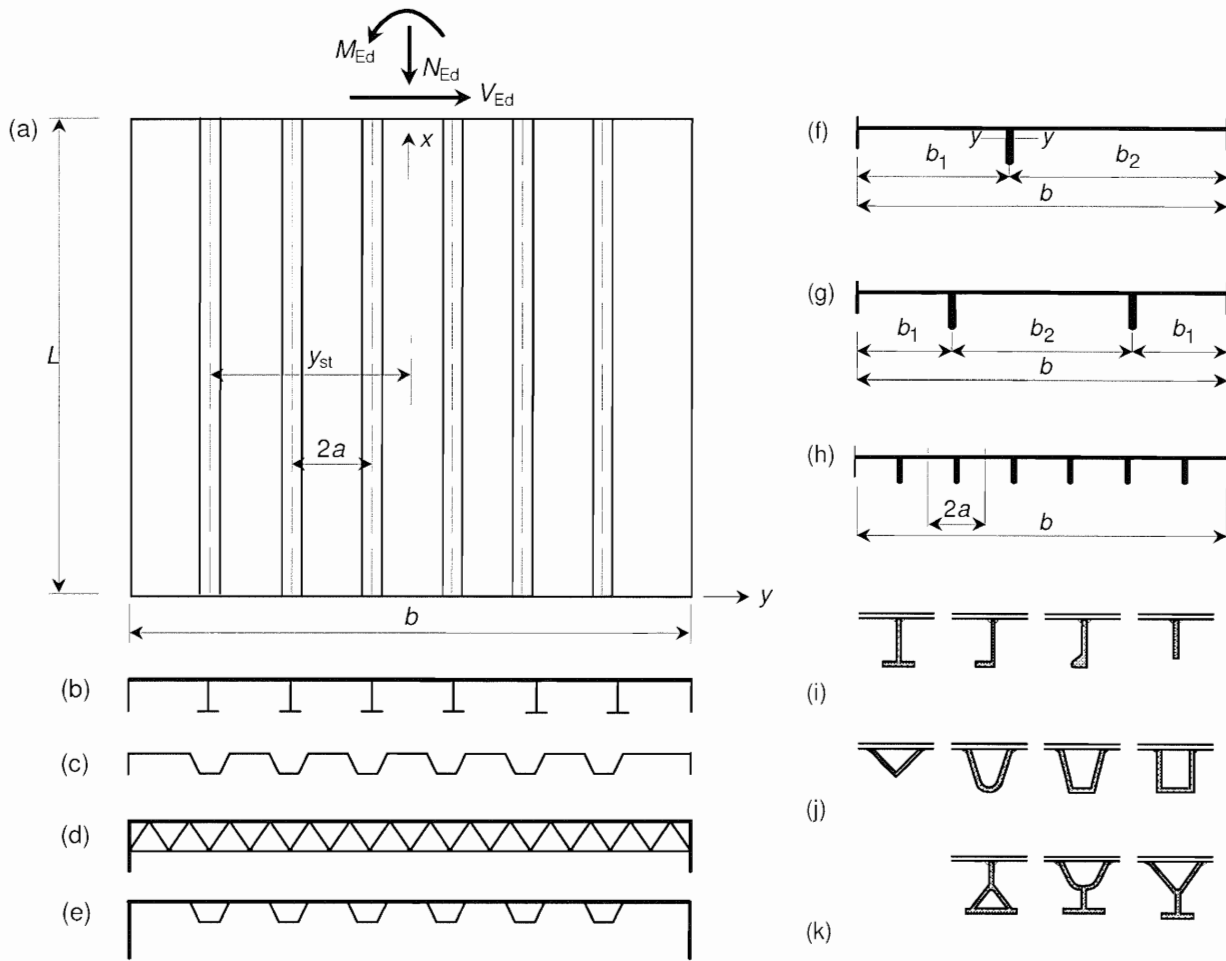

(i) open stiffeners, (j) closed stiffeners, (k) combined stiffeners

Figure 6.23 - Stiffened plates and types of stiffeners

(4) If the structure consists of flat plating with $\overline{A_1}$ longitudinal stiffeners, the resistance to transverse direct stress may be taken the same as for an unstiffened plate. With corrugated structure it is negligible. Orthotropic plating may have considerable resistance to transverse in-plane direct stress $\overline{A_1}$.

6.6.2 Stiffened plates under uniform compression

(1)P General

The cross-section shall be classified as compact or slender in accordance with 6.1.4, considering all the component parts before carrying out either check.

The design value of the compression force N_{Ed} shall satisfy

$$\frac{N_{Ed}}{N_{Rd}} \leq 1,0 \quad (6.91)$$

where N_{Rd} is the lesser of $N_{u,Rd}$ and $N_{c,Rd}$ according to (2) and (3).

(2) Yielding check

The entire section should be checked for local squashing in the same way as for a strut (see 6.3). The design resistance $N_{u,Rd}$ should be based on the net section area A_{net} for the least favourable cross-section, taking account of $\overline{A_1}$ text deleted $\overline{A_1}$ HAZ softening if necessary, and also any unfilled holes.

$$N_{u,Rd} = A_{net} f_u / \gamma_{M2} \quad (6.92)$$

(3) Column check

The plating is regarded as an assemblage of identical column sub-units, each containing one centrally located stiffener or corrugation and with a width equal to the pitch $\overline{\lambda} 2a$. The design axial resistance $N_{c,Rd}$ is then taken as:

$$N_{c,Rd} = A_{eff} \chi f_o / \gamma_{M1} \quad (6.93)$$

where:

χ is the reduction factor for flexural buckling

A_{eff} is the effective area of the cross-section of the plating allowing for local buckling and HAZ softening due to longitudinal welds. HAZ softening due to welds at the loaded edges or at transverse stiffeners may be ignored in finding A_{eff} . Also unfilled holes may be ignored.

The reduction factor χ should be obtained from the appropriate column curve relevant to column buckling of the sub-unit as a simple strut out of the plane of the plating.

(4) The relative slenderness parameter $\overline{\lambda}$ in calculating χ is

$$\overline{\lambda} = \sqrt{\frac{A_{eff} f_o}{N_{cr}}} \quad (6.94)$$

where

N_{cr} = the elastic orthotropic buckling load based on the gross cross-section

(5) For a plate with *open stiffeners*:

$$N_{cr} = \frac{\pi^2 EI_y}{L^2} + \frac{L^2 c}{\pi^2} \quad \text{if } L < \pi \sqrt[4]{\frac{EI_y}{c}} \quad (6.95)$$

$$N_{cr} = 2\sqrt{c EI_y} \quad \text{if } L \geq \pi \sqrt[4]{\frac{EI_y}{c}} \quad (6.96)$$

where c is the elastic support from the plate according to expressions (6.97), (6.98) or (6.99) and I_y is the second moment of area of all stiffeners and plating within the width b with respect to y -axes in Figure 6.23f.

(6) For a cross-section part with *one central or eccentric stiffener* (Figure 6.23(f)):

$$c = \frac{0,27 Et^3 b}{b_1^2 b_2^2} \quad (6.97)$$

where t is the thickness of the plate, b is the overall width of the plate and b_1 and b_2 are the width of plate parts on both sides of the stiffener.

(7) For a cross-section part with *two symmetrical stiffeners* located a distance b_1 from the longitudinal supports (Figure 6.23(g)):

$$c = \frac{1,1 Et^3}{b_1^2 (3b - 4b_1)} \quad (6.98)$$

(8) For a *multi-stiffened plate with open stiffeners* (Figure 6.23(c), (b) (h) and (i)) with small torsional stiffness

$$c = \frac{8,9 Et^3}{b^3} \quad (6.99)$$

(9) For a *multi-stiffened plate with closed or partly closed stiffeners* (Figure 6.23 (e) and (j))

N_{cr} is the elastic orthotropic buckling load. See 6.6.6.

(10) The half-wavelength in elastic buckling, used if the applied action varies in the direction of the stiffener or corrugations (see 6.6.4(3)) is

$$l_w = \pi \sqrt[4]{\frac{EI_y}{c}} \quad (6.100)$$

6.6.3 Stiffened plates under in-plane moment

(1) General

Two checks should be performed, a yielding check (see 6.6.3(3)) and a column check (see 6.6.3(4)).

(2) Section classification and local buckling

The cross-section should be classified as Classes 2, 3 and 4 (see 6.1.4) when carrying out either check. For the purpose of classifying individual parts, and also when determining effective thicknesses for slender parts, $\square A1$ it should generally be assumed $\square A1$ that each part is under uniform compression taking $\eta = 1$ in 6.1.4.3. However, in the case of the yielding check only, it is permissible to base η on the actual stress pattern in parts comprising the outermost region of the plating, and to repeat this value for the corresponding parts further in. This may be favourable if the number of stiffeners or corrugations is small.

(3) Yielding check

The entire cross-section of the plating should be treated as a beam under in-plane bending (see 6.2.5). The design moment resistance M_{Rd} should be based on the least favourable cross-section, taking account of local buckling and HAZ softening if necessary, and also any holes.

(4) Column check

The plating is regarded as an assemblage of column sub-units in the same general way as for axial compression (see 6.6.2(3)), the design moment resistance $\square A1$ $M_{o,Rd}$ $\square A1$ being taken as follows

$$\square A1$$
 $M_{o,Rd} = \frac{\chi I_{eff} f_o}{y_{st} \gamma_{M1}}$ $\square A1$ (6.101) $\square A1$

where:

$\square A1$ χ is the reduction factor for flexural buckling of sub-unit

I_{eff} is the second moment of area of the effective cross-section of the plating for in-plane bending

y_{st} is the distance from centre of plating to centre of outermost stiffener

The reduction factor χ $\square A1$ should be determined in the same way as for uniform compression (see 6.6.2(3)).

6.6.4 Longitudinal stress gradient on multi-stiffened plates

(1) General

Cases where the applied action N_{Ed} or M_{Ed} on a multi-stiffened plate varies in the direction of the stiffeners or corrugations are described in 6.6.4(2) and 6.6.4(3).

(2) Yielding check

The design resistance at any cross-section should be not less than the design action effect arising at that section.

(3) Column check

For the column check it is sufficient to compare the design resistance with the design action effect arising at a distance $0,4l_w$ from the more heavily loaded end of a panel, where l_w is the half wavelength in elastic buckling according to 6.6.2(10).

6.6.5 Multi-stiffened plating in shear

(1) A yielding check (see (2)) and a buckling check (see (3)) should be performed. The methods given in 6.6.5(2) and (3) are valid provided the stiffeners or corrugations, as well as the actual plating, are as follows:

- a) effectively connected to the transverse framing at either end;
- b) continuous at any transverse stiffener position.

(2) Yielding check: The design shear force resistance V_{Rd} is taken as the same as that for a flat unstiffened plate of the same overall aspect ($L \times b$) ~~Ⓐ~~ in accordance with 6.5.5(2).

(3) Buckling check: The design shear force resistance is found from 6.8.2. In order to calculate the resistance the following values should be used (Note difference in coordinate system, x and y in Figure 6.23 are z and x in Figure 6.33):

$$B_y = Et^3 / 10,9 \text{ for a flat plate with stiffeners, otherwise see 6.6.6(1)}$$

Ⓐ $B_x = EI_y / b$ where I_y is the second moment of area of stiffeners Ⓐ and plating within the width b about a centroidal axis parallel to the plane of the plating
 h_w is the buckling length l which may be safely taken as the unsupported length L (see Figure 6.23). If L greatly exceeds b , a more favourable result may be obtained by putting $V_{o,cr}$ equal to the elastic orthotropic shear buckling force. No allowance for HAZ softening needs to be made in performing the buckling check.

6.6.6 Buckling load for orthotropic plates

(1) For an orthotropic plate under *uniform compression* the procedure in 6.6.2 may be used. The elastic orthotropic buckling load N_{cr} for a simply supported orthotropic plate is given by

$$N_{cr} = \frac{\pi^2}{b} \left[\frac{B_x}{(L/b)^2} + 2H + B_y (L/b)^2 \right] \quad \text{if } \frac{L}{b} < 4 \sqrt{\frac{B_x}{B_y}} \quad (6.102)$$

$$N_{cr} = \frac{2\pi^2}{b} \left[\sqrt{B_x B_y} + H \right] \quad \text{if } \frac{L}{b} \geq 4 \sqrt{\frac{B_x}{B_y}} \quad (6.103)$$

Expressions for B_x , B_y and H for different cross-sections are given in Table 6.11 where the expressions Ⓐ (6.104) to (6.110) Ⓐ are given below. (Indexes x and y indicates rigidity in section $x = \text{constant}$ and $y = \text{constant}$, respectively).

Table 6.11, Case No. 2:

$$B_y = \frac{2B a}{2a_4 + \frac{2a_1 a_3 t_1^3 (4a_2 t_3^3 + a_3 t_2^3)}{a_3 t_1^3 (4a_2 t_3^3 + a_3 t_2^3) + a_1 t_3^3 (12a_2 t_3^3 + 4a_3 t_2^3)}} \quad (6.104)$$

$$H = 2B + \frac{G I_t}{2 a} \left[1 + \frac{3,3 G I_t a_4^2}{L_b^2 a B} \left[1 + \frac{1}{\pi^4 C_1 / L_b^4 + C_2} \right] \right] \quad (6.105)$$

where

$$L_b = L \quad \text{but } L_b \leq \frac{b}{3} \sqrt[4]{\frac{B_x}{B_y}} \quad (6.105a)$$

$$C_1 = 4(1-\nu^2)(a_2 + a_3) a_1^2 a_4^2 h^2 t_2 / (3a_1 t_1^3) \quad (6.106)$$

$$B = \frac{E t_1^3}{12(1-\nu^2)} \quad (6.107)$$

$$C_2 = \frac{4(a_1 + a_2)^2 a_1 a_4 (1 + a_1 / a_2 + a_2 / a_1 + a^2 / (a_1 a_3)) \left(\frac{t_2}{t_1} \right)^3}{a_2^3 (3a_3 + 4a_2)} \quad (6.108)$$

Table 6.11, Case No. 5:

$$B_y = \frac{1}{\frac{1}{B_v} + \frac{t_1 + t_2}{E t_1 t_2 h^2}} \quad (6.109)$$

where:

$$B_v = \frac{E t_1^3}{12(1-\nu^2)} \frac{10b^2}{32a^2} \frac{a t_3^3 + a t_2^3 t_3^3 / t_1^3 + 6h t_2^3}{a t_3^3 + 2h(t_1^3 + t_2^3) + 3h^2 t_1^3 t_2^3 / (a t_3^3)} \quad (6.109a)$$

$$H = \frac{2E}{3 \left(1 - \frac{t_3}{2a} \right)^3} \left[\frac{t_1^3}{1 + \frac{6t_1}{2a - t_3}} + \frac{t_2^3}{1 + \frac{6t_2}{2a - t_3}} \right] \quad (6.110)$$

Table 6.11 - Flexural and torsional rigidity of orthotropic plates

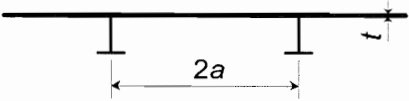
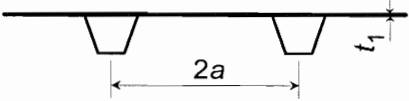
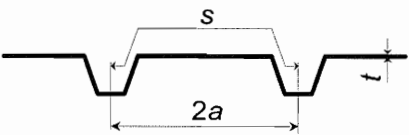
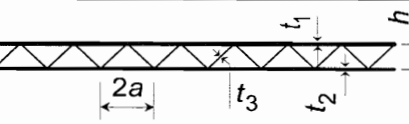
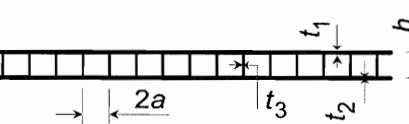
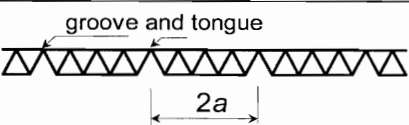
Case No	Cross-section	B_x (corresponds to EI_y)	B_y (corresponds to EI_x)	H
1		$\frac{EI_L}{2a}$	$\frac{Et^3}{12(1-\nu^2)}$	$\frac{Gt^3}{6}$
2		$\frac{EI_L}{2a}$	Eq.(6.104)	Eq. (6.105)
3		$\frac{EI_L}{2a}$	$\frac{2a}{s} \frac{Et^3}{12(1-\nu^2)}$	$\frac{2a}{s} \frac{Gt^3}{6}$
4		$\frac{EI_L}{2a}$	$\frac{Et_1 t_2 h^2}{t_1 + t_2}$	$\frac{GI_t}{2a}$
5		$\frac{EI_L}{2a}$	Eq. (6.109)	Eq. (6.110)
6		$\frac{EI_L}{2a}$	0	$\frac{GI_t}{2a}$

I_L is the second moment of area of one stiffener and adjacent plating within $2a$.
 I_t is the torsional constant of the same cross-section.

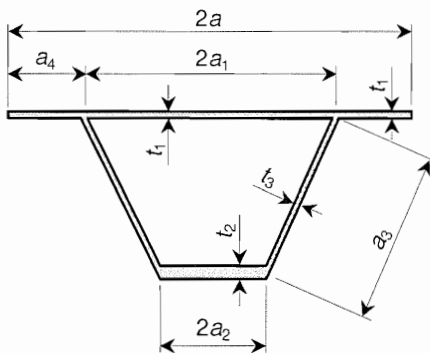

Figure 6.24 - Cross-section notations of closed stiffener

(2) The shear force resistance for an orthotropic plate with respect to global buckling can for $\phi \leq 1$ be calculated according to 6.8.2(3) where:

$$\tau_{cr,g} = \frac{k_\tau \pi^2}{LA} \sqrt[4]{B_y B_x^3} \quad (6.111)$$

$$k_\tau = 3,25 - 0,567\phi + 1,92\phi^2 + (1,95 + 0,1\phi + 2,75\phi^2) \eta_h \quad (6.112)$$

$$\phi = \frac{L}{b} \sqrt[4]{\frac{B_y}{B_x}} \quad (6.113)$$

$$\eta_h = \frac{H}{\sqrt{B_x B_y}} \quad (\text{Valid for } \eta_h < 1,5) \quad (6.114)$$

B_x , B_y and H are given in Table 6.11 and A is cross section area in smallest section for $y = \text{constant}$ ($A = Lt$ for cases 1, 2 and 3 in Table 6.11 and $A = L(t_1 + t_2)$ for 4 and 5. Not applicable to case 6).

For originally $\phi > 1$ interchange subscripts x and y and widths b and L in (6.111) and (6.113) and use $A = b \sum t$.

6.7 Plate girders

6.7.1 General

(1) A plate girder is a deep beam with a tension flange, a compression flange and a web plate. The web is usually slender and may be reinforced transversally with bearing and intermediate stiffeners. It can also be reinforced by longitudinal stiffeners.

(2) Webs buckle in shear at relatively low applied loads, but considerable amount of post-buckled strength can be mobilized due to tension field action. Plate girders are sometimes constructed with transverse web reinforcement in the form of corrugations or closely-spaced transverse stiffeners.

(3) Plate girders can be subjected to combinations of moment, shear and axial loading, and to local loading on the flanges. Because of their slender proportions they may be subjected to lateral torsional buckling, unless properly supported along their length.

(4) The rules for plate girders given in this Standard are generally applicable to the side members of box girders.

Failure modes and references to clauses with resistance expressions are given in Table 6.12.

Table 6.12 - Buckling modes and corresponding clause with resistance expressions

Buckling mode	Clause
Web buckling by compressive stresses	6.7.2 and 6.7.3
Shear buckling	6.7.4 and 6.8
Interaction between shear force and bending moment	6.7.6
Buckling of web because of local loading on flanges	6.7.5
Flange induced web buckling	6.7.7
Torsional buckling of flange (local buckling)	6.1.5
Lateral torsional buckling	6.3.2

6.7.2 Resistance of girders under in-plane bending

(1) A yielding check and a buckling check should be made, and for webs with continuous longitudinal welds the effect of the HAZ should be investigated. The HAZ effect caused by the welding of transverse stiffeners may be neglected and small holes in the web may be ignored provided they do not occupy more than 20 % of the cross-sectional area of the web. The web depth between flanges is h_w and the distance between the weld toes of the flanges is b_w .

(2)P For the yielding check, the design value of the moment, M_{Ed} at each cross-section shall satisfy

$$M_{Ed} \leq M_{o,Rd} \quad (6.115)$$

where $M_{o,Rd}$, for any class cross-section, is the design moment resistance of the cross-section that would apply if the section were designated class 3. Thus,

$$M_{o,Rd} = W_{net} f_o / \gamma_{M1} \quad (6.116)$$

where W_{net} is the elastic modulus allowing for holes and taking a reduced thickness $\rho_{o,haz} t$ in regions adjacent to the flanges which might be affected by HAZ softening (see 6.1.6.2).

(3) In applying the buckling check it is assumed that transverse stiffeners comply with the requirements of the effective stiffener section given in 6.7.8. It is also assumed that the spacing between adjacent transverse stiffeners is greater than half the clear depth of the web between flange plates. If this is not the case, refer to 6.8 for corrugated or closely stiffened webs.

(4) For each bay of the girder of length a between transverse stiffeners, the moment arising under design load at a distance $0,4 a$ from the more heavily stressed end should not exceed the design moment resistance, $M_{o,Rd}$ for that bay, where:

$$M_{o,Rd} = W_{eff} f_o / \gamma_{M1} \quad (6.117)$$

W_{eff} is the effective elastic modulus obtained by taking a reduced thickness to allow for buckling as well as HAZ softening, but with the presence of holes ignored. The reduced thickness is equal to the lesser of $\rho_{o,haz} t$ and $\rho_{ct} t$ in HAZ regions, and $\rho_c t$ elsewhere, see 6.2.5.

(5) The thickness is reduced in any class 4 part that is wholly or partly in compression (b_c in Figure 6.25). The stress ratio ψ used in 6.1.4.3 and corresponding width b_c may be obtained using the effective area of the compression flange and the gross area of the web, see Figure 6.25(c), gravity centre G_1 .

(6) If the compression edge of the web is nearer to the neutral axis of the girder than in the tension flange, see Figure 6.25(c), the method in 6.1.4.3 may be used.

This procedure generally requires an iterative calculation in which ψ is determined again at each step from the stresses calculated on the effective cross-section defined at the end of the previous step.

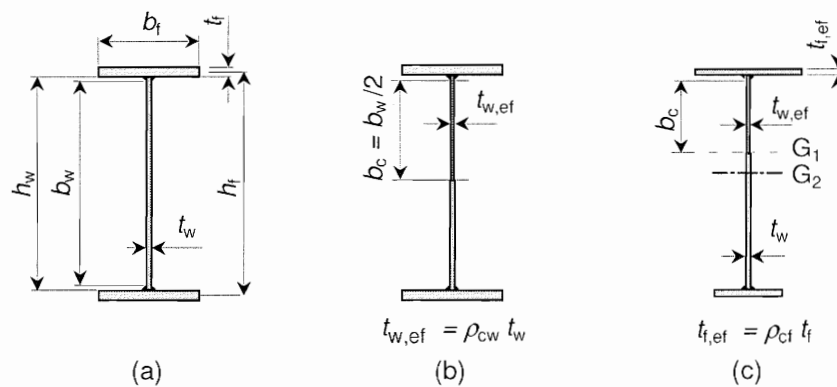

- (a) Cross-section notations.
 (b) Effective cross-section for a symmetric plate girder with class 1, 2 and 3 flanges.
 (c) Effective cross-section for a girder with smaller tension (bottom) flange and a class 4 compression (top) flange

Figure 6.25 - Plate girder in bending

6.7.3 Resistance of girders with longitudinal web stiffeners

(1) Plate buckling due to longitudinal compressive stresses may be taken into account by the use of an effective cross-section applicable to class 4 cross-sections.

(2) The effective cross-section properties should be based on the effective areas of the compression parts and their locations within the effective cross-section.

(3) In a first step the effective areas of flat compression sub panels between stiffeners should be obtained using effective thicknesses according to 6.1.5. See Figure 6.26.

(4) Overall plate buckling, including buckling of the stiffeners, is considered as flexural buckling of a column consisting of the stiffeners and half the adjacent part of the web. If the stresses change from compression to tension within the sub panel, one third of the compressed part is taken as part of the column. See Figure 6.26(c).

(5) The effective thicknesses of the different parts of the column section are further reduced in a second step with a reduction factor χ obtained from the appropriate column curve relevant for column buckling of the column as a simple strut out of the plane of the web.

(6) The relative slenderness parameter $\bar{\lambda}$ in calculating χ is

$$\bar{\lambda} = \sqrt{\frac{A_{st,eff} f_o}{N_{cr}}} \quad (6.118)$$

where

$A_{st,eff}$ is the effective area of the column from the first step, see Figure 6.26c. N_{cr} is the elastic buckling load given by the following expression:

$$N_{cr} = 1,05 E \frac{\sqrt{I_{st} t_w^3 b_w}}{b_1 b_2} \quad \text{if } a > a_c \quad (6.119)$$

$$N_{cr} = \frac{\pi^2 E I_{st}}{a^2} + \frac{E t_w^3 b_w a^2}{4\pi^2 (1-\nu^2) b_1^2 b_2^2} \quad \text{if } a \leq a_c \quad (6.120)$$

$$a_c = 4,33 \sqrt[4]{\frac{I_{st} b_1^2 b_2^2}{t_w^3 b_w}} \quad (6.121)$$

where:

I_{st} is second moment of area of the gross cross-section of the stiffener and adjacent part of web (see (7)) about an axis through its centroid and parallel to the plane of the web

b_1 and b_2 are distances from longitudinal edges to the stiffener ($b_1 + b_2 = b_w$).

a_c is the half wave length for elastic buckling of stiffener

(7) For calculation of I_{st} the column consists of the actual stiffener together with an effective width $15t_w$ of the web plate on both sides of the stiffener. See Figure 6.26(d1) and (d2).

(8) In case of two longitudinal stiffeners, both in compression, the two stiffeners are considered as lumped together, with an effective area and a second moment of area equal to the sum of those of the individual stiffeners. The location of the lumped stiffener is the position of the resultant of the axial forces in the stiffeners. If one of the stiffeners is in tension the procedure will be conservative.

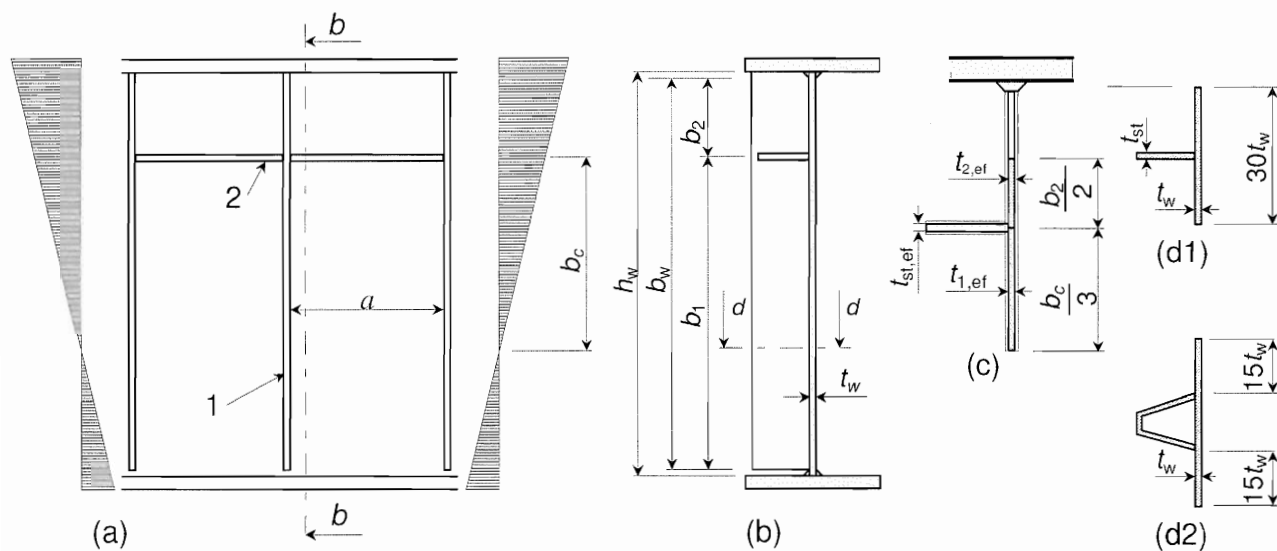

(a) Stiffened web, (b) cross-section, (c) effective area of stiffener column, (d1), (d2) column cross-section for calculation of I_{st} ,
1 transverse stiffener, 2 longitudinal stiffener

Figure 6.26 - Stiffened web of plate girder in bending

6.7.4 Resistance to shear

(1) This section gives rules for plate buckling effects from shear force where the following criteria are met:

- a) panels are rectangular and flanges are parallel within an angle not greater than 10° ;
- b) stiffeners if any are provided in the longitudinal and /or transverse direction;
- c) open holes or cut outs are small and limited to diameters d that satisfies $d/h_w \leq 0,05$ where h_w is the width of the plate;
- d) members are uniform.

(2)P A plate girder in shear shall be verified against buckling as follows:

$$\frac{V_{Ed}}{V_{Rd}} \leq 1,0$$

where:

V_{Ed} is the design value of the shear force

V_{Rd} is the design resistance for shear, see 6.7.4.1 or 6.7.4.2.

6.7.4.1 Plate girders with web stiffeners at supports

(1) This section gives rules for plate buckling effects from shear force where stiffeners are provided at supports only.

(2) Plates with $h_w / t_w > (2,37 / \eta) \sqrt{E / f_o}$ should be checked for resistance to shear buckling.

NOTE For η see Table 6.13, for h_w and t_w see Figure 6.27.

(3) For webs with transverse stiffeners at supports only, the design resistance V_{Rd} for shear should be taken as

$$V_{Rd} = \rho_v t_w h_w \frac{f_o}{\sqrt{3} \cdot \gamma_{M1}} \tag{6.122}$$

in which ρ_v is a factor for shear buckling obtained from Table 6.13 or Figure 6.28.

Table 6.13 - Factor ρ_v for shear buckling

Ranges of λ_w	Rigid end post	Non-rigid end post
$\lambda_w \leq 0,83/\eta$	η	η
$0,83/\eta < \lambda_w < 0,937$	$0,83/\lambda_w$	$0,83/\lambda_w$
$0,937 \leq \lambda_w$	$2,3/(1,66 + \lambda_w)$	$0,83/\lambda_w$

$\eta = 0,7 + 0,35 f_{uw} / f_{ow}$ but not more than 1,2 where f_{ow} is the strength for overall yielding and f_{uw} σ_{yk} is the ultimate strength of the web material.

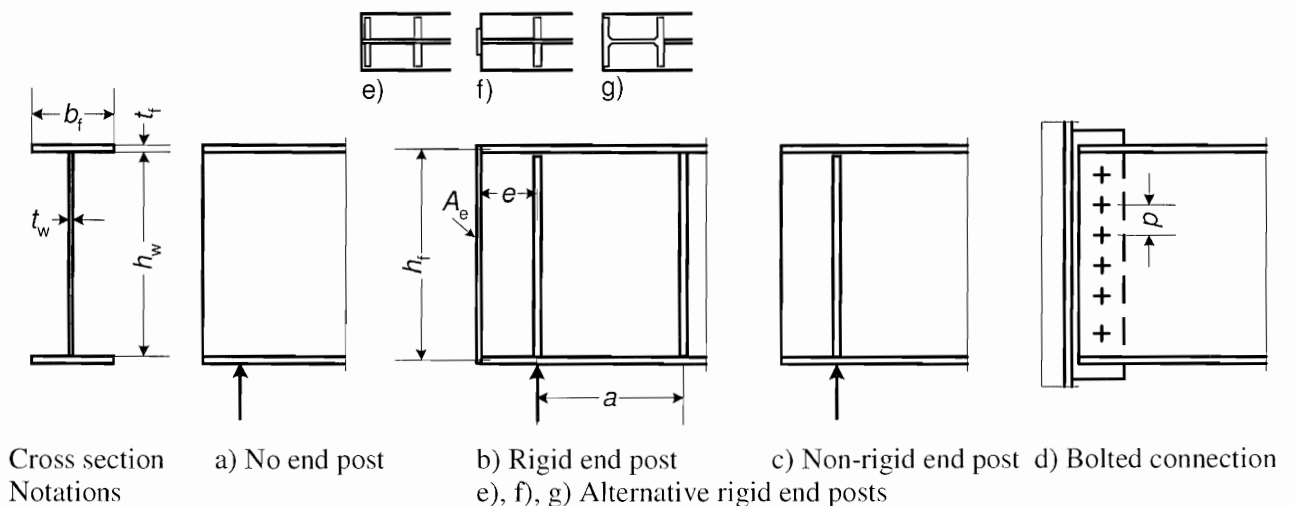
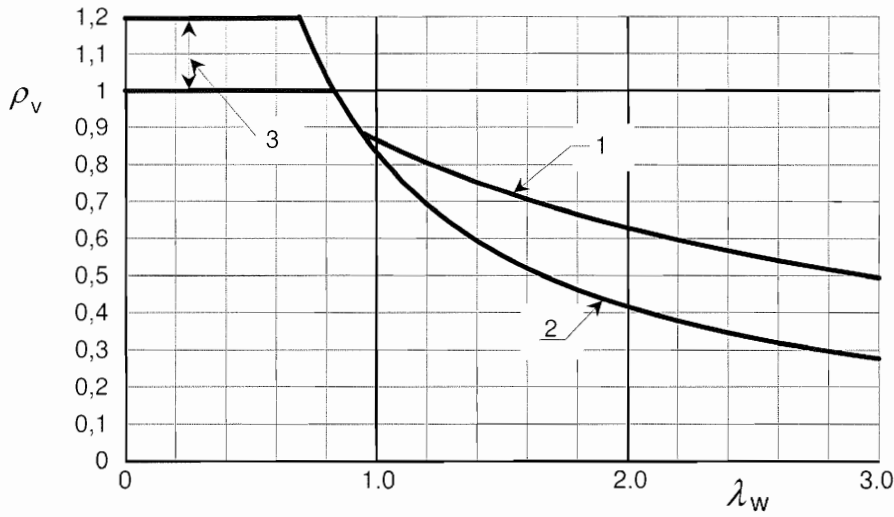

Figure 6.27 - End-stiffeners

Figure 6.27 shows various end supports for girders:

a) no end post, see 6.7.5, type c);

- b) rigid end posts, see 6.7.8.1. This case is also applicable for panels not at the end of the girder and at an intermediate support of a continuous girder;
- c) non-rigid end posts, see 6.7.8.2;
- d) bolted connection, see 6.7.8.2, to be classified as non-rigid in resistance calculation.



1 Rigid end post, 2 Non-rigid end post, 3 Range of η

Figure 6.28 - Factor ρ_v for shear buckling

(3) The slenderness parameter λ_w in Table 6.13 and Figure 6.28 is

$$\lambda_w = 0,35 \frac{b_w}{t_w} \sqrt{\frac{f_0}{E}} \quad (6.123)$$

6.7.4.2 Plate girders with intermediate web stiffeners

(1) This section gives rules for plate buckling effects from shear force where web stiffeners are provided in the longitudinal and/or transverse direction

(2) Plates with $h_w / t_w > (1,02 / \eta) \sqrt{k_\tau E / f_0}$ should be checked for resistance to shear buckling and should be provided with transverse stiffeners at the supports.

NOTE For η see Table 6.13, for h_w and t_w see Figure 6.29 and for k_τ see (6)

(3) For beams with transverse and longitudinal stiffeners the design resistance for shear buckling V_{Rd} is the sum of the contribution $V_{w,Rd}$ of the web and $V_{f,Rd}$ of the flanges.

$$V_{Rd} = V_{w,Rd} + V_{f,Rd} \quad (6.124)$$

in which $V_{w,Rd}$ includes partial tension field action in the web according to (4) and $V_{f,Rd}$ is an increase of the tension field caused by local bending resistance of the flanges according to (10).

(4) The contribution from the web to the design resistance for shear should be taken as:

$$\boxed{A1} \quad V_{w,Rd} = \rho_v t_w h_w \frac{f_0}{\sqrt{3} \cdot \gamma_{M1}} \quad (6.125) \quad \boxed{A1}$$

where ρ_v is the factor for shear buckling obtained from Table 6.13 or Figure 6.28.

(5) The slenderness parameter λ_w is

$$\lambda_w = \frac{0,81}{\sqrt{k_\tau}} \frac{b_w}{t_w} \sqrt{\frac{f_0}{E}} \quad (6.126)$$

in which k_{τ} is the minimum shear buckling coefficient for the web panel. Rigid boundaries may be assumed if flanges and transverse stiffeners are rigid, see 6.7.8.3. The web panel is then the panel between two adjacent transverse stiffeners.

(6) The second moment of area of the longitudinal stiffeners should be reduced to $1/3$ $\overline{A_1}$ of its value $\overline{A_1}$ when calculating k_{τ} . Formulae for k_{τ} taking this into account are given in (7) and (8).

(7) For plates with rigid transverse stiffeners and without longitudinal stiffeners or more than two longitudinal stiffeners, the shear buckling coefficient k_{τ} in (5) is:

$$k_{\tau} = 5,34 + 4,00(b_w/a)^2 + k_{\tau st} \quad \text{if } a/b_w \geq 1 \quad (6.127)$$

$$k_{\tau} = 4,00 + 5,34(b_w/a)^2 + k_{\tau st} \quad \text{if } a/b_w < 1 \quad (6.128)$$

where:

$$k_{\tau st} = 9 \left(\frac{b_w}{a} \right)^2 \left(\frac{I_{st}}{t_w^3 b_w} \right)^{\frac{3}{4}} \quad \text{but not less than } \frac{2,1}{t_w} \left(\frac{I_{st}}{b_w} \right)^{\frac{1}{3}} \quad (6.129)$$

a is the distance between transverse stiffeners. See Figure 6.29.

I_{st} is the second moment of area of the longitudinal stiffener with regard to the z -axis. See Figure 6.29(b). For webs with two or more equal stiffeners, not necessarily equally spaced, I_{st} $\overline{A_1}$ is the second moment of area of all individual stiffeners. $\overline{A_1}$

(8) The expression (6.129) also applies to plates with one or two longitudinal stiffeners, if the aspect ratio $a/b_w \geq 3$. For plates with one or two longitudinal stiffeners and an aspect ratio $a/b_w < 3$ the shear buckling coefficient should be taken from:

$$k_{\tau} = 4,1 + \frac{6,3 + 0,18 I_{st} / (t_w^3 b_w)}{a^2} + 2,2 \left(\frac{I_{st}}{t_w^3 b_w} \right)^{\frac{1}{3}} \quad (6.129a)$$

(9) For webs with longitudinal stiffeners the relative slenderness parameter λ_w should be taken not less than

$$\lambda_w = \frac{0,81}{\sqrt{k_{\tau 1}}} \frac{b_{w1}}{t_w} \sqrt{\frac{f_o}{E}} \quad (6.130)$$

where $k_{\tau 1}$ and b_{w1} refers to the sub-panel with the largest slenderness parameter λ_w of all subpanels within the webpanel under consideration. To calculate $k_{\tau 1}$ the expression in 6.7.4.2(7) may be used with $k_{\tau st} = 0$.

(10) If the flange resistance is not completely utilized in withstanding the bending moment ($M_{Ed} < M_{f,Rd}$, curve (1) in Figure 6.32) the shear resistance contribution $V_{f,Rd}$ from the flanges may be included in the shear buckling resistance as follows:

$$V_{f,Rd} = \frac{b_f t_f^2 f_{of}}{c \gamma_{MI}} \left(1 - \left(\frac{M_{Ed}}{M_{f,Rd}} \right)^2 \right) \quad (6.131)$$

in which b_f and t_f are taken for the flange leading to the lowest resistance,

b_f being taken as not larger than $15t_f$ on each side of the web

$M_{f,Rd}$ is the design moment resistance of the cross section considering of the effective flanges only

$$c = a \left(0,08 + \frac{4,4 b_f t_f^2 f_{of}}{t_w b_w^2 f_{ow}} \right) \quad (6.131a)$$

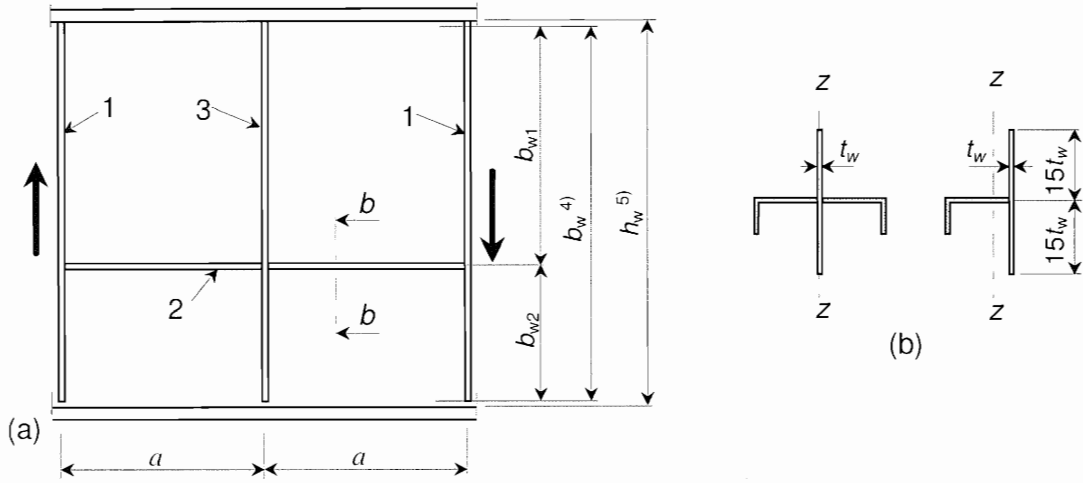

1 Rigid transverse stiffener, 2 Longitudinal stiffener, 3 Non-rigid transverse stiffener,
 4) Distance between fillets, 5) between flanges

Figure 6.29 - Web with transverse and longitudinal stiffeners

(11) If an axial force N_{Ed} is present, the value of $M_{f,Rd}$ should be reduced by a factor

$$\left(1 - \frac{N_{Ed}}{(A_{f1} + A_{f2}) f_{of} / \gamma_{M1}} \right) \tag{6.132}$$

where A_{f1} and A_{f2} are the areas of the top and bottom flanges.

Ⓜ(12)Ⓜ If $M_{Ed} \geq M_{f,Rd}$ then $V_{f,Rd} = 0$. For further interaction, see 6.7.6.

6.7.5 Resistance to transverse loads

6.7.5.1 Basis

(1) The resistance of the web of extruded beams and welded girders to transverse forces applied through a flange may be determined from the following rules, provided that the flanges are restrained in the lateral direction either by their own stiffness or by bracings.

(2) A load can be applied as follows:

- a. Load applied through one flange and resisted by shear forces in the web. See Figure 6.30(a).
- b. Load applied to one flange and transferred through the web to the other flange, see Figure 6.30(b)
- c. Load applied through one flange close to an un-stiffened end, see Figure 6.30(c).

(3) For box girders with inclined webs the resistance of both the web and flange should be checked. The internal forces to be taken into account are the components of the external load in the plane of the web and flange respectively.

(4)P The resistance of the web to transverse forces applied through a flange shall be verified as follows:

$$\frac{F_{Ed}}{F_{Rd}} \leq 1,0 \tag{6.133}$$

where:

F_{Ed} is the design transverse force;

F_{Rd} is the design resistance to transverse forces, see 6.7.5.2;

(5) The interaction of the transverse force, bending moment and axial force should be verified using 6.7.6.2.

6.7.5.2 Design resistance

(1) For un-stiffened or stiffened webs the design resistance F_{Rd} to local buckling under transverse loads should be taken as

$$F_{Rd} = L_{eff} t_w f_{ow} / \gamma_{M1} \quad (6.134)$$

where:

f_{ow} is the characteristic value of strength of the web material.

L_{eff} is the effective length for resistance to transverse loads, which should be determined from

$$L_{eff} = \chi_F l_y \quad (6.135)$$

where:

l_y is the effective loaded length, see 6.7.5.5, appropriate to the length of stiff bearings s_s , see 6.7.5.3

χ_F is the reduction factor due to local buckling, see 6.7.5.4.

6.7.5.3 Length of stiff bearing

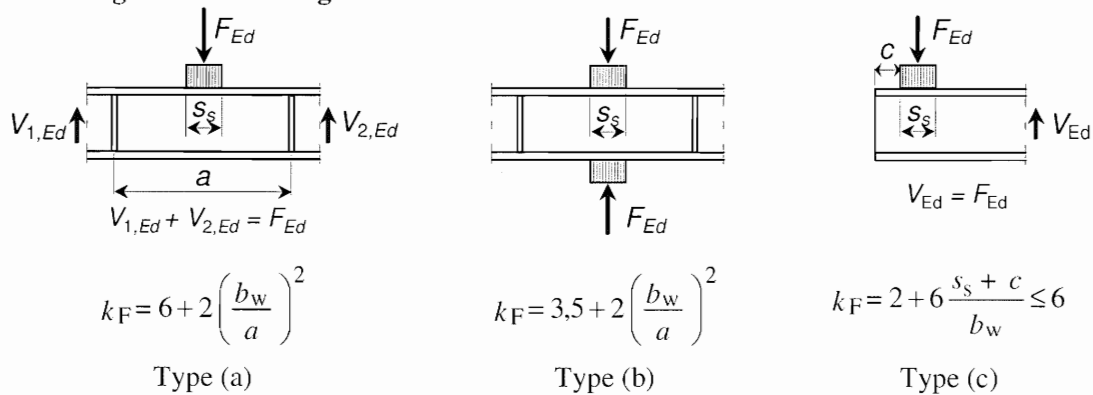

Figure 6.30 - Load applications and buckling coefficients

(1) The length of stiff bearing, s_s , on the flange is the distance over which the applied load is effectively distributed and it may be determined by dispersion of load through solid material at a slope of 1:1, see Figure 6.31. However, s_s should not be taken as larger than b_w .

(2) If several concentrated loads are closely spaced (s_s for individual loads > distance between loads), the resistance should be checked for each individual load as well as for the total load with s_s as the centre-to-centre distance between the outer loads.

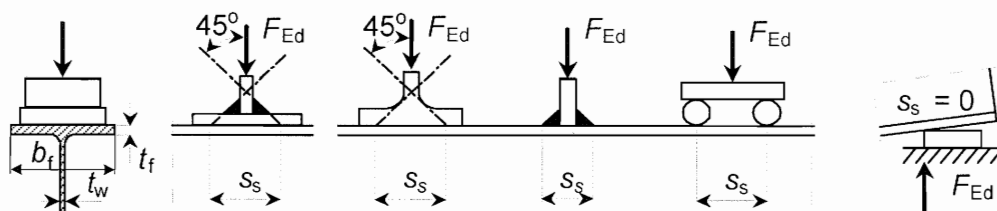

Figure 6.31 - Length of stiff bearing

6.7.5.4 Reduction factor χ_F for resistance

(1) The reduction factor χ_F for resistance should be obtained from:

$$\chi_F = \frac{0,5}{\lambda_F} \text{ but not more than } 1,0 \quad (6.136)$$

where:

$$\lambda_F = \sqrt{\frac{l_y t_w f_{ow}}{F_{cr}}} \quad (6.137)$$

$$F_{cr} = 0,9 k_F E t_w^3 / h_w \quad (6.138)$$

l_y is effective loaded length obtained from 6.7.5.5.

(2) For webs without longitudinal stiffeners the factor k_F should be obtained from Figure 6.30

(3) For webs with longitudinal stiffeners k_F should be taken as

$$k_F = 6 + 2(h_w / a)^2 + (5,44 b_1 / a - 0,21) \sqrt{\gamma_s} \quad (6.139)$$

where:

b_1 is the depth of the loaded sub-panel taken as the clear distance between the loaded flange and the stiffener

$$\gamma_s = 10,9 I_{s1} / (h_w t_w^3) \leq 13(a / h_w)^3 + 210(0,3 - b_1 / h_w) \quad (6.140)$$

where I_{s1} is the second moment of area (about z-z axis) of the stiffener closest to the loaded flange including contributing parts of the web according to Figure 6.29. Equation (6.140) is valid for $0,05 \leq b_1 / h_w \leq 0,3$ and loading according to type (a) in Figure 6.30.

6.7.5.5 Effective loaded length

(1) The effective loaded length l_y should be calculated using the two dimensionless parameters m_1 and m_2 obtained from

$$m_1 = \frac{f_{of} b_f}{f_{ow} t_w} \quad (6.141)$$

$$m_2 = 0,02 \left(\frac{h_w}{t_f} \right)^2 \text{ if } \lambda_F > 0,5 \text{ otherwise } m_2 = 0 \quad (6.142)$$

where b_f is the flange width, see Figure 6.31. For box girders, b_f in expression (6.141) is limited to $15t_f$ on each side of the web.

(2) For cases (a) and (b) in Figure 6.30, l_y should be obtained using:

$$l_y = s_s + 2t_f \left(1 + \sqrt{m_1 + m_2} \right), \text{ but } l_y \leq \text{distance between adjacent transverse stiffeners} \quad (6.143)$$

(3) For case (c) in Figure 6.30, l_y should be obtained as the smaller of the values obtained from the equations (6.143), (6.144) and (6.145). However, s_s in (6.143) should be taken as zero if the structure that introduces the force does not follow the slope of the girder, see Figure 6.31.

$$l_y = l_e + t_f \sqrt{\frac{m_1}{2} + \left(\frac{l_e}{t_f} \right)^2 + m_2} \quad (6.144)$$

$$l_y = l_e + t_f \sqrt{m_1 + m_2} \quad (6.145)$$

$$l_e = \frac{k_F E t_w^2}{2 f_{ow} h_w} \leq s_s + c \quad (6.146)$$

6.7.6 Interaction

6.7.6.1 Interaction between shear force, bending moment and axial force

(1) Provided that the flanges can resist the whole of the design value of the bending moment and axial force in the member, the design shear resistance of the web need not be reduced to allow for the moment and axial force in the member, except as given in 6.7.4.2(10).

(2) If $M_{Ed} > M_{f,Rd}$ the following two expressions (corresponding to curve (2) and (3) in Figure 6.32) should be satisfied:

$$\frac{M_{Ed} + M_{f,Rd}}{2M_{pl,Rd}} + \frac{V_{Ed}}{V_{w,Rd}} \left(1 - \frac{M_{f,Rd}}{M_{pl,Rd}} \right) \leq 1,00 \quad (6.147)$$

$$\boxed{A_1} M_{Ed} \leq M_{o,Rd} \quad \boxed{A_1}$$

where:

$\boxed{A_1} M_{o,Rd}$ is the design bending moment resistance according to 6.7.2 (4), $\boxed{A_1}$

$M_{f,Rd}$ is the design bending moment resistance of the flanges only $\boxed{A_1} (= \min(A_{f1} h_f f_o / \gamma_{M1}, A_{f2} h_f f_o / \gamma_{M1}))$, $\boxed{A_1}$

$M_{pl,Rd}$ is the plastic design bending moment resistance

(3) If an axial force N_{Ed} is also applied, then $M_{pl,Rd}$ should be replaced by the reduced plastic moment resistance $M_{N,Rd}$ given by

$$M_{N,Rd} = M_{pl,Rd} \left(1 - \left(\frac{N_{Ed}}{(A_{f1} + A_{f2}) f_o / \gamma_{M1}} \right)^2 \right) \quad (6.148)$$

where A_{f1}, A_{f2} are the areas of the flanges.

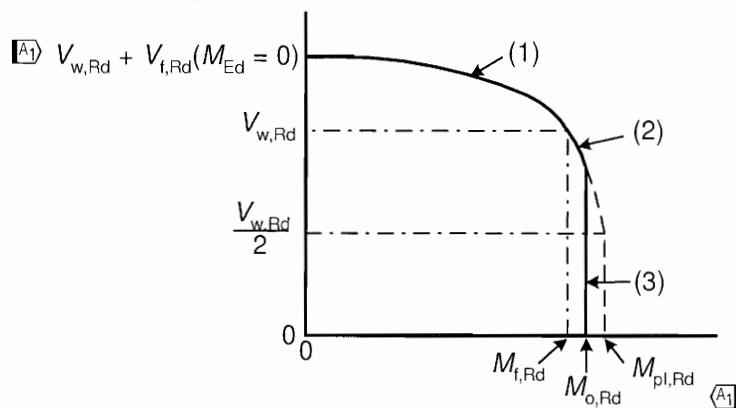

Figure 6.32 - Interaction of shear force resistance and bending moment resistance

6.7.6.2 Interaction between transverse force, bending moment and axial force

(1) If the girder is subjected to a concentrated force acting on the compression flange in conjunction with bending moment and axial force, the resistance should be verified using 6.2.9, 6.7.5.1 and the following interaction expression

$$\boxed{A_1} \frac{F_{Ed}}{F_{Rd}} + 0,8 \left(\frac{M_{Ed}}{M_{o,Rd}} + \frac{N_{Ed}}{N_{c,Rd}} \right) \leq 1,4 \quad (6.149) \quad \boxed{A_1}$$

where:

- Ⓐ) $M_{o,Rd}$ is the design bending moment resistance according to 6.7.2 (4). Ⓐ)
- $N_{c,Rd}$ is the design axial force resistance, see 6.3.1.1.

(2) If the concentrated force is acting on the tension flange the resistance according to 6.7.5 should be verified and in addition also 6.2.1(5)

6.7.7 Flange induced buckling

(1) To prevent the possibility of the compression flange buckling in the plane of the web, the ratio b_w / t_w of the web should satisfy the following expression

$$\frac{b_w}{t_w} \leq \frac{k E}{f_{of}} \sqrt{\frac{A_w}{A_{fc}}} \quad (6.150)$$

where:

- A_w is the cross section area of the web
- A_{fc} is the cross section area of the compression flange
- Ⓐ) f_{of} is the 0,2% proof strength of the flange material Ⓐ)

The value of the factor k should be taken as follows:

- plastic rotation utilized $k = 0,3$
- plastic moment resistance utilized $k = 0,4$
- Ⓐ) - elastic moment of resistance utilized $k = 0,55$ Ⓐ)

(2) If the girder is curved in elevation, with the compression flange on the concave face, the ratio b_w / t_w for the web should satisfy the following criterion:

$$\frac{b_w}{t_w} \leq \frac{kE}{f_{of}} \sqrt{\frac{A_w}{A_{fc}}} \frac{1}{\sqrt{1 + \frac{b_w E}{3 r f_{of}}}} \quad (6.151)$$

in which r is the radius of curvature of the compression flange.

(3) If the girder is provided with transverse web stiffeners, the limiting value of b_w / t_w may be increased by the factor $1 + (b_w / a)^2$.

6.7.8 Web stiffeners

6.7.8.1 Rigid end post

(1) The rigid end post (see Figure 6.27) should act as a bearing stiffener resisting the reaction from bearings at the girder support, and as a short beam resisting the longitudinal membrane stresses in the plane of the web.

(2) A rigid end post may comprise of one stiffener at the girder end and one double-sided transverse stiffener that together form the flanges of a short beam of length h_f , see Figure 6.27(b). The strip of web plate between the stiffeners forms the web of the short beam. Alternatively, an end post may be in the form of an inserted section, connected to the end of the web plate.

Ⓐ) (3) The double-sided transverse stiffener may act as a bearing stiffener resisting the reaction at the girder support (see 6.2.11).

(4) The stiffener at the girder end should have a cross-sectional area of at least $4h_f t_w^2 / e$ where e is the centre to centre distance between the stiffeners and $e > 0,1h_f$, see Figure 6.27(b). Ⓐ)

- A1** (5) If an end post is the only means of providing resistance against twist at the end of a girder, the second moment of area of the end-post section about the centre-line of the web (I_{ep}) should satisfy: **A1**

$$I_{ep} \geq b_w^3 t_f R_{Ed} / (250 W_{Ed}) \quad (6.152)$$

where:

- t_f is the maximum value of flange thickness along the girder
- R_{Ed} is the reaction at the end of the girder under design loading
- W_{Ed} is the total design loading on the adjacent span.

6.7.8.2 Non-rigid end post and bolted connection

(1) A non-rigid end post may be a single double-sided stiffener as shown in Figure 6.27(c). It may act as a bearing stiffener resisting the reaction at the girder support (see 6.2.11).

(2) The shear force resistance for a bolted connection as shown in Figure 6.27(c) may be assumed to be the same as for a girder with a non-rigid end post provided that the distance between bolts is $p < 40t_w$.

6.7.8.3 Intermediate transverse stiffeners

(1) Intermediate stiffeners that act as rigid supports of interior panels of the web should be checked for strength and stiffness.

(2) Other intermediate transverse stiffeners may be considered flexible, their stiffness being considered in the calculation of k_τ in 6.7.4.2.

(3) Intermediate transverse stiffeners acting as rigid supports for web panels should have a minimum second moment of area I_{st} :

$$\text{if } a/h_w < \sqrt{2}: \quad I_{st} \geq 1,5h_w^3 t_w^3 / a^2 \quad (6.153)$$

$$\text{if } a/h_w \geq \sqrt{2}: \quad I_{st} \geq 0,75h_w t_w^3 \quad (6.154)$$

The strength of intermediate rigid stiffeners should be checked for an axial force equal to $V_{Ed} - \rho_v b_w t_w f_v / \gamma_{M1}$ where ρ_v is calculated for the web panel between adjacent transverse stiffeners assuming the stiffener under consideration removed. In the case of variable shear forces the check is performed for the shear force at distance $0,5h_w$ from the edge of the panel with the largest shear force.

6.7.8.4 Longitudinal stiffeners

(1) Longitudinal stiffeners may be either rigid or flexible. In both cases their stiffness should be taken into account when determining the relative slenderness λ_w in 6.7.4.2(5).

(2) If the value of λ_w is governed by the sub-panel then the stiffener may be considered as rigid.

(3) The strength should be checked for direct stresses if the stiffeners are taken into account for resisting direct stress.

6.7.8.5 Welds

(1) The web to flange welds may be designed for the nominal shear flow V_{Ed} / h_w if V_{Ed} does not exceed $\rho_v h_w t_w f_o / (\sqrt{3} \gamma_{M1})$. For larger values the weld between flanges and webs should be designed for the shear flow $\eta t_w f_o / (\sqrt{3} \gamma_{M1})$ unless the state of stress is investigated in detail.

6.8 Members with corrugated webs

(1) For plate girders with trapezoidal corrugated webs, see Figure 6.33, the bending moment resistance is given in 6.8.1 and the shear force resistance in 6.8.2.

NOTE 1 Cut outs are not included in the rules for corrugated webs.

NOTE 2 For transverse loads the rules in 6.7.7 can be used as a conservative estimate.

6.8.1 Bending moment resistance

(1) The bending moment resistance may be derived from:

$$M_{Rd} = \min \left\{ \begin{array}{l} b_2 t_2 h_f f_{o,r} / \gamma_{M1} \\ b_1 t_1 h_f f_{o,r} / \gamma_{M1} \\ b_1 t_1 h_f \chi_{LT} f_{o,r} / \gamma_{M1} \end{array} \right. \quad \begin{array}{l} \text{tension flange} \\ \text{compression flange} \\ \text{compression flange} \end{array} \quad (6.155)$$

where $f_{o,r} = \rho_z f_o$ includes the reduction due to transverse moments in the flanges

$$\rho_z = 1 - 0,4 \sqrt{\frac{\sigma_x(M_z)}{f_o / \gamma_{M1}}} \quad (6.156)$$

M_z is the transverse bending moment in the flange

χ_{LT} is the reduction factor for lateral torsional buckling according to 6.3.2.

NOTE The transverse moment M_z may result from the shear flow introduction in the flanges as indicated in Figure 6.33(d).

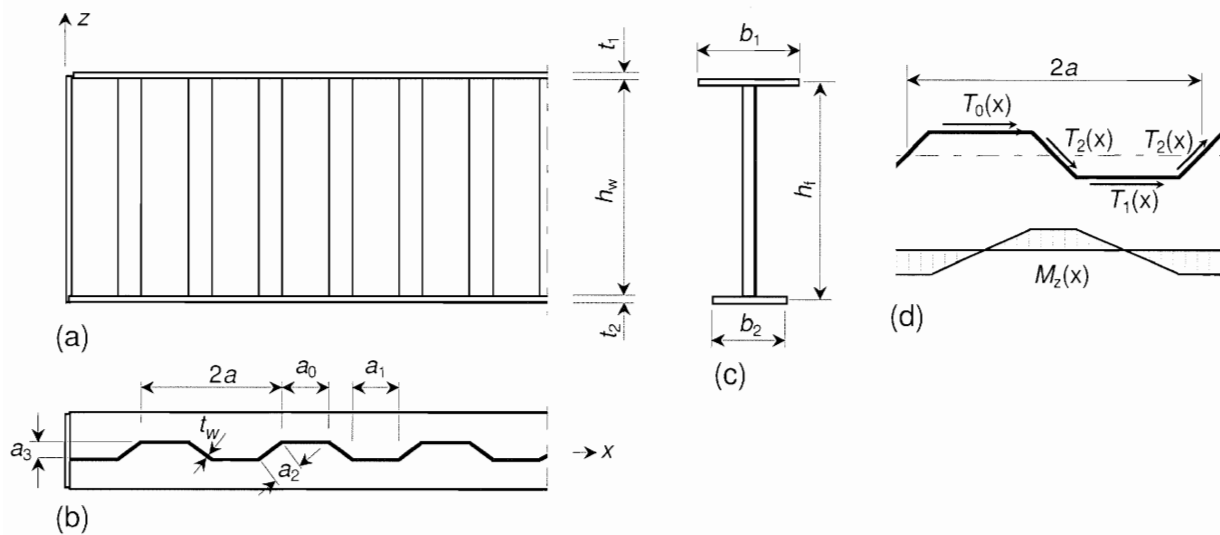

Figure 6.33 - Corrugated web

6.8.2 Shear force resistance

(1) The shear force resistance V_{Rd} may be taken as

$$V_{Rd} = \rho_c t_w h_w \frac{f_o}{\sqrt{3} \cdot \gamma_{M1}} \quad (6.157)$$

where ρ_c is the smallest of the reduction factors for local buckling $\rho_{c,l}$, reduction factor for global buckling $\rho_{c,g}$ and HAZ softening factor $\rho_{o,haz}$:

(2) The reduction factor $\rho_{c,l}$ for local buckling may be calculated from:

$$\rho_{c,l} = \frac{1,15}{0,9 + \lambda_{c,l}} \leq 1,0 \quad (6.158)$$

where the relative slenderness $\lambda_{c,l}$ for trapezoidal corrugated webs may be taken as

$$\lambda_{c,l} = 0,35 \frac{a_{\max}}{t_w} \sqrt{\frac{f_o}{E}} \quad (6.159)$$

with a_{\max} as the greatest width of the corrugated web plate panels, a_0 , a_1 or a_2 , see Figure 6.33.

(3) The reduction factor $\rho_{c,g}$ for global buckling should be taken as

$$\rho_{c,g} = \frac{1,5}{0,5 + \lambda_{c,g}^2} \leq 1,0 \quad (6.160)$$

where the relative slenderness $\lambda_{c,g}$ may be taken as

$$\lambda_{c,g} = \sqrt{\frac{f_o}{\sqrt{3} \tau_{cr,g}}} \quad (6.161)$$

where the value $\tau_{cr,g}$ may be taken from:

$$\tau_{cr,g} = \frac{32,4}{t_w h_w^2} \sqrt[4]{B_x B_z^3} \quad (6.162)$$

where:

$$B_x = \frac{2a}{a_0 + a_1 + 2a_2} \frac{Et_w^3}{10,9}$$

$$B_z = \frac{EI_x}{2a}$$

$2a$ is length of corrugation, see Figure 6.33

a_0 , a_1 and a_2 are widths of folded web panels, see Figure 6.33

I_x is second moment of area of one corrugation of length $2a$, see Figure 6.33.

NOTE Equation (6.162) applies to plates with hinged edges.

(4) The reduction factor $\rho_{o,haz}$ in HAZ is given in 6.1.6.

7 Serviceability Limit States

7.1 General

- (1)P A1 An aluminium A1 structure shall be designed and constructed such that all relevant serviceability criteria are satisfied.
- (2) The basic requirements for serviceability limit states are given in 3.4 of EN 1990.
- (3) Any serviceability limit state and the associated loading and analysis model should be specified for a project.
- (4) Where plastic global analysis is used for the ultimate limit state, plastic redistribution of forces and moments at the serviceability limit state may occur. If so, the effects should be considered.

NOTE The National Annex may give further guidance.

7.2 Serviceability limit states for buildings

7.2.1 Vertical deflections

- (1) With reference to EN 1990 – Annex A1.4 limits for vertical deflections according to Figure A1.1 in EN 1990 should be specified for each project and agreed with the owner of the construction work.

NOTE The National Annex may specify the limits.

7.2.2 Horizontal deflections

- (1) With reference to EN 1990 – Annex A1.4 limits for horizontal deflections according to Figure A1.2 in EN 1990 should be specified for each project and agreed with the owner of the construction work.

NOTE The National Annex may specify the limits.

7.2.3 Dynamic effects

- (1) With reference to EN 1990 – Annex A1.4.4 the vibrations of structures on which the public can walk should be limited to avoid significant discomfort to users, and limits should be specified for each project and agreed with the owner of the construction work.

NOTE The National Annex may specify limits for vibration of floors.

7.2.4 Calculation of elastic deflection

- (1) The calculation of elastic deflection should generally be based on the properties of the gross cross-section of the member. However, for slender sections it may be necessary to take reduced section properties to allow for local buckling (see section 6.7.5). Due allowance of effects of partitioning and other stiffening effects, second order effects and changes in geometry should also be made.

- (2) For class 4 sections the following effective second moment of area I_{ser} , constant along the beam may be used

$$I_{\text{ser}} = I_{\text{gr}} - \frac{\sigma_{\text{gr}}}{f_0} (I_{\text{gr}} - I_{\text{eff}}) \quad (7.1)$$

where:

I_{gr} is the second moment of area of the gross cross-section

I_{eff} is the second moment of area of the effective cross-section at the ultimate limit state, with allowance for local buckling, A1 see 6.2.5.2 A1

σ_{gr} is the maximum compressive bending stress at the serviceability limit state, based on the gross cross-section (positive in the formula).

- (3) Deflections should be calculated making also due allowance for the rotational stiffness of any semi-rigid joints, and the possible recurrence of local plastic deformation at the serviceability limit state.

8 Design of joints

8.1 Basis of design

8.1.1 Introduction

(1)P All joints shall have a design resistance such that the structure remains effective and is capable of satisfying all the basic design requirements given in 2.

(2) The partial safety factors γ_M for joints should be applied to the characteristic resistance for the various types of joints.

NOTE Numerical values for γ_M may be defined in the National Annex. Recommended values are given in Table 8.1

Table 8.1 - Recommended partial factors γ_M for joints

Resistance of members and cross-sections	γ_{M1} and γ_{M2} see 6.1.3
Resistance of bolt connections	$\gamma_{M2} = 1,25$
Resistance of rivet connections	
Resistance of plates in bearing	
Resistance of pin connections	$\gamma_{Mp} = 1,25$
Resistance of welded connections	$\gamma_{Mw} = 1,25$
Slip resistance, see 8.5.9.3	$\gamma_{Ms,ser} = 1,1$ $\gamma_{Ms,ult} = 1,25$
- for serviceability limit states	
- for ultimate limit states	
Resistance of adhesive bonded connections	$\gamma_{Ma} \geq 3,0$
Resistance of pins at serviceability limit state	$\gamma_{Mp,ser} = 1,0$

(3) Joints subject to fatigue should also satisfy the rules given in EN 1999-1-3.

8.1.2 Applied forces and moments

(1) The forces and moments applied to joints at the ultimate limit state should be determined by global analysis conforming to 5.

(2) These applied forces and moments should include:

- second order effects;
- the effects of imperfections (see 5.3);
- the effects of connection flexibility

NOTE For the effect of connection flexibility, see Annex L.

8.1.3 Resistance of joints

(1) The resistance of a joint should be determined on the basis of the resistances of the individual fasteners, welds and other components of the joint.

(2) Linear-elastic analysis should generally be used in the design of the joint. Alternatively non-linear analysis of the joint may be employed provided that it takes account of the load deformation characteristics of all the components of the joint.

(3) If the design model is based on yield lines such as block shear i.e., the adequacy of the model should be demonstrated on the basis of physical tests.

8.1.4 Design assumptions

(1) Joints may be designed by distributing the internal forces and moments in whatever rational way is best, provided that:

- (a) the assumed internal forces and moments are in equilibrium with the applied forces and moments;
- (b) A1 each part A1 in the joint is capable of resisting the forces or stresses assumed in the analysis;
- (c) the deformations implied by this distribution are within the deformation capacity of the fasteners or welds and of the connected parts, and
- (d) the deformations assumed in any design model based on yield lines are based on rigid body rotations (and in-plane deformations) which are physically possible.

(2) In addition, the assumed distribution of internal forces should be realistic with regard to relative stiffness within the joint. The internal forces will seek to follow the path with the greatest rigidity. This path should be clearly identified and consistently followed throughout the design of the joint.

(3) Residual stresses and stresses due to tightening of fasteners and due to ordinary accuracy of fit-up need not usually be allowed for.

8.1.5 Fabrication and execution

(1) Ease of fabrication and execution should be considered in the design of all joints and splices.

(2) Attention should be paid to:

- the clearances necessary for safe execution;
- the clearances needed for tightening fasteners;
- the need for access for welding;
- the requirements of welding procedures, and
- the effects of angular and length tolerances on fit-up.

(3) Attention should also be paid to the requirements for:

- subsequent inspection;
- surface treatment, and
- maintenance.

Requirements to execution of aluminium structures are given in A1 EN 1090-3 A1 .

8.2 Intersections for bolted, riveted and welded joints

(1) Members meeting at a joint should usually be arranged with their centroidal axes intersecting at a point.

(2) Any kind of eccentricity in the nodes should be taken into account, except in the case of particular types of structures where it has been demonstrated that it is not necessary.

8.3 Joints loaded in shear subject to impact, vibration and/or load reversal

- A1** (1) Where a joint loaded in shear is subject to frequent impact or significant vibration either welding, preloaded bolts, injection bolts or other types of bolts, which effectively prevent movement and loosening of fastener, should be used.
- (2) Where slipping is not acceptable in a joint because it is subject to reversal of shear load (or for any other reason), preloaded bolts in a slip-resistant connection (category B or C as appropriate, see 8.5.3), fitted bolts or welding should be used.
- (3) For wind and/or stability bracings, bolts in bearing type connections (category A in 8.5.3) may be used. **A1**

8.4 Classification of joints

NOTE Recommendations for classification of joints are given in Annex L.

8.5 Connections made with bolts, rivets and pins

8.5.1 Positioning of holes for bolts and rivets

- (1) The positioning of holes for bolts and rivets should be such as to prevent corrosion and local buckling and to facilitate the installation of the bolts or rivets.
- (2) In case of minimum end distances, minimum edge distances and minimum spacings no minus tolerances are allowed.
- (3) The positioning of the holes should also be in conformity with the limits of validity of the rules used to determine the design resistances of the bolts and rivets.
- (4) Minimum and maximum spacing, end and edge distances are given in Table 8.2.

Table 8.2 - Minimum, regular and maximum spacing, end and edge distances

1	2	3	4	5
Distances and spacings, see Figures 8.1 and 8.2	Minimum	Regular distance	Maximum ^{1) 2) 3)}	
			Structures made of aluminium according to Table 3.1a	
			Aluminium exposed to the weather or other corrosive influences	Aluminium not exposed to the weather or other corrosive influences
End distance e_1	$1,2d_0$ ⁶⁾	$2,0d_0$	$4t + 40$ mm	The larger of $12t$ or 150 mm
Edge distance e_2	$1,2d_0$ ⁶⁾	$1,5d_0$	$4t + 40$ mm	The larger of $12t$ or 150 mm
End distance e_3 for slotted holes ⁴⁾	Slotted holes are not recommended. Slotted holes of category A see $\overline{A1}$ 8.5.1(5) $\overline{A1}$ – (10)			
Edge distance e_4 for slotted holes ⁴⁾	Slotted holes are not recommended Slotted holes of category A see $\overline{A1}$ 8.5.1(5) $\overline{A1}$ – (10)			
Compression members (see Figure 8.2): Spacing p_1	$2,2d_0$	$2,5d_0$	Compression members: The smaller of $14t$ or 200 mm	Compression members: The smaller of $14t$ or 200 mm
Tension members (see Figure 8.3): Spacing $p_1, p_{1,0}, p_{1,i}$	$2,2d_0$	$2,5d_0$	Outer lines: The smaller of $14t$ or 200 mm Inner lines: The smaller of $28t$ or 400 mm	1,5 times the values of column 4
Spacing p_2 ⁵⁾	$2,4d_0$	$3,0d_0$	The smaller of $14t$ or 200 mm	The smaller of $14t$ or 200 mm
<p>¹⁾ Maximum values for spacings, edge and end distances are unlimited, except in the following cases:</p> <ul style="list-style-type: none"> - for compression members in order to avoid local buckling and to prevent corrosion in exposed members and; - for exposed tension members to prevent corrosion. <p>²⁾ The local buckling resistance of the plate in compression between the fasteners should be calculated according to $\overline{A1}$ 6.3 $\overline{A1}$ $\overline{A1}$ text deleted $\overline{A1}$ by using $0,6 p_1$ as buckling length. Local buckling between the fasteners need not to be checked if p_1/t is smaller than 9ε. The edge distance should not exceed the maximum to satisfy local buckling requirements for an outstand part in the compression members, see 6.4.2 - 6.4.5. $\overline{A1}$ Text deleted $\overline{A1}$</p> <p>³⁾ t is the thickness of the thinner outer connected part.</p> <p>⁴⁾ Slotted holes are not recommended, slotted holes of category A see 8.5.1 (5)</p> <p>⁵⁾ For staggered rows of fasteners a minimum line spacing $p_2 = 1,2d_0$ may be used, if the minimum distance between any two fasteners in a staggered row is $p_1 = 2,4d_0$, see Figure 8.2.</p> <p>⁶⁾ The minimum values of e_1 and e_2 should be specified with no minus deviation but only plus deviations.</p>				

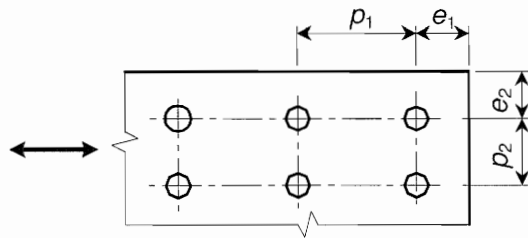

Figure 8.1 - Symbols for spacing of fasteners

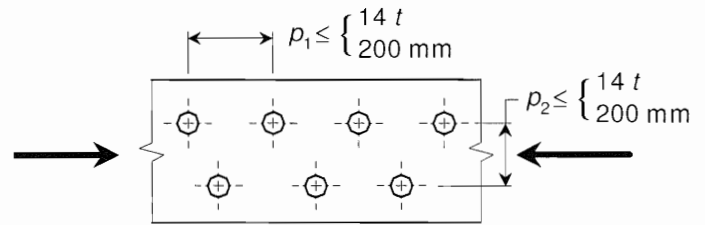

Figure 8.2 - Staggered spacing – compression

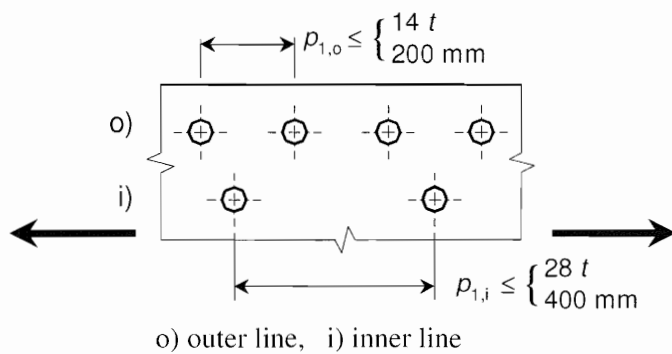

Figure 8.3 - Spacing in tension member

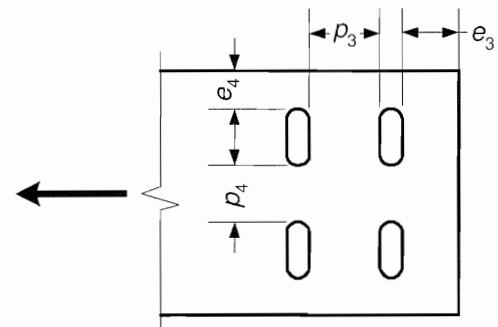

Figure 8.4 - Slotted holes

(5) Slotted holes are not recommended. However, slotted holes may be used in connections of the category A with loads only perpendicular to the direction of the slotted hole.

(6) The length between the extreme edges of a slotted hole in the direction of the slot should be either $1,5(d + 1 \text{ mm})$ (short slotted hole) or $2,5(d + 1 \text{ mm})$ (long slotted hole) but not larger.

(7) The width of the hole perpendicular to the slot, i.e. in the direction of the load, should be not greater than $d + 1 \text{ mm}$.

(8) The distance e_3 between the edge of the hole and the end of the member in the direction of the load should be greater than $1,5(d + 1 \text{ mm})$, the distance e_4 between the edge of the hole and the edge of the member perpendicular to the direction of the load should be greater than $d + 1 \text{ mm}$.

(9) The distance p_3 between the edges of two adjacent holes in the direction of the load and the distance p_4 between the edges of two adjacent holes perpendicular to the direction of the load should be greater than $2(d + 1 \text{ mm})$.

(10) Bolts in slotted holes according to category A should be verified according to Table 8.5, see 8.5.5.

(11) For oversized holes the rules in (8), (9) and (10) apply.

A1 (12) Oversized holes in bolted connections of Category A may be used if the following conditions are met:

- a possible greater setting of the structure or of the component can be accepted;
- no reversal loads are acting;
- oversized bolts holes are used on one side of a joint, where they should be applied in the component to be connected or in the connecting devices (cover plates, gussets);
- the rules for geometrical tolerances for oversized holes given in EN 1090-3 are applied;
- for bolts with diameter $d \leq 10 \text{ mm}$ the design resistance of the bolt group based on bearing is less than the design resistance of the bolt group based on shear. See also 8.5.5 (7). **A1**

8.5.2 Deductions for fastener holes

8.5.2.1 General

(1) For detailed rules for the design of members with holes see 6.3.4.

8.5.2.2 Design for block tearing resistance

(1) Block tearing consists of failure in shear at the row of bolts along the shear face of the hole group accompanied by tensile failure along the line of bolt holes on the tension face of the bolt group. Figure 8.5 shows block tearing.

(2) For a symmetric bolt group subject to concentric loading the design block tearing resistance, $V_{\text{eff},1,Rd}$ is given by:

$$V_{\text{eff},1,Rd} = f_u A_{nt} / \gamma_{M2} + (1 / \sqrt{3}) f_o A_{nv} / \gamma_{M1} \quad (8.1)$$

where:

A_{nt} is net area subjected to tension;

A_{nv} is net area subjected to shear.

(3) For a bolt group subject to eccentric loading the design block shear tearing resistance $V_{\text{eff},2,Rd}$ is given by:

$$V_{\text{eff},2,Rd} = 0,5 f_u A_{nt} / \gamma_{M2} + (1 / \sqrt{3}) f_o A_{nv} / \gamma_{M1} \quad (8.2)$$

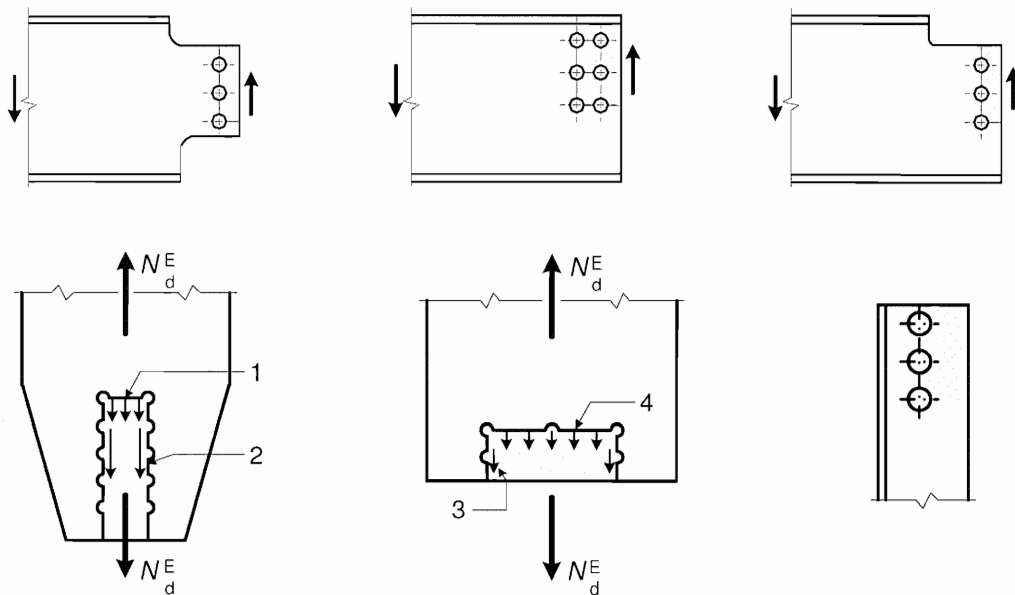

1 small tension force, 2 large shear force, 3 small shear force and 4 large tension force

Figure 8.5 - Block tearing

8.5.2.3 Angles and angles with bulbs

(1) In the case of unsymmetrical or unsymmetrically $\overline{A_1}$ connected members under tension and compression $\overline{A_1}$ bulbs, the eccentricity of fasteners in end connections and the effects of the spacing and edge distances of the bolts should be taken into account when determining the design resistances.

(2) Angles and angles with bulbs connected by a single row of bolts, see Figure 8.6, may be treated as concentrically loaded and the design ultimate resistance of the net section determined as follows:

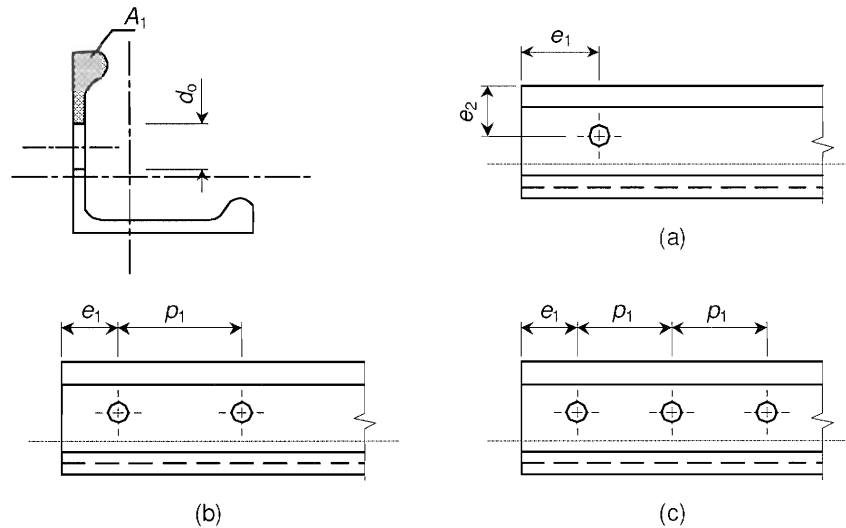

(a) One bolt, (b) two bolts and (c) three bolts

Figure 8.6 - \square_{A1} Connection of angles \square_{A1}

with 1 bolt:
$$N_{u,Rd} = \frac{2A_1 f_u}{\gamma_{M2}} \quad (8.3)$$

with 2 bolts:
$$N_{u,Rd} = \frac{\beta_2 A_{net} f_u}{\gamma_{M2}} \quad (8.4)$$

with 3 bolts:
$$N_{u,Rd} = \frac{\beta_3 A_{net} f_u}{\gamma_{M2}} \quad (8.5)$$

where:

β_2 and β_3 are reduction factors dependent on the pitch p_1 as given in Table 8.3 for intermediate values p_1 the values of β may be determined by linear interpolation.

A_{net} is the net area of the angle. For an unequal-leg angle connected by its smaller leg, A_{net} should be taken as equal to the net section area of an equivalent equal-leg angle of leg size equal to that of the smaller leg.

\square_{A1} Text deleted \square_{A1}

Table 8.3 - Reduction factors β_2 and β_3

Pitch p_1	$\leq 2,5 d_0$	$\geq 5,0 d_0$
β_2 for 2 bolts	0,4	0,7
β_3 for 3 bolts or more	0,5	0,7

8.5.3 Categories of bolted connections

8.5.3.1 Shear connections

(1) The design of a bolted connection loaded in shear should conform to one of the following categories, see Table 8.4.

Table 8.4 - Categories of bolted connections

Shear connections		
Category	Criteria	Remarks
A; bearing type	$F_{v,Ed} \leq F_{v,Rd}$ $F_{v,Ed} \leq F_{b,Rd}$ $\Sigma F_{v,Ed} \leq N_{net,Rd}$	No preloading required. All grades from 4.6 to 10.9. $N_{net,Rd} = 0,9A_{net}f_u / \gamma_{M2}$
B; slip resistant at serviceability	$F_{v,Ed,ser} \leq F_{s,Rd,ser}$ $F_{v,Ed} \leq F_{v,Rd}$ $F_{v,Ed} \leq F_{b,Rd}$ $\Sigma F_{v,Ed} \leq N_{net,Rd}$ $\Sigma F_{v,Ed,ser} \leq N_{net,Rd,ser}$	Preloaded high strength bolts. No slip at the serviceability limit state. $N_{net,Rd} = 0,9A_{net}f_u / \gamma_{M2}$ $N_{net,Rd,ser} = A_{net}f_o / \gamma_{M1}$
C; slip resistant at ultimate	$F_{v,Ed} \leq F_{s,Rd}$ $F_{v,Ed} \leq F_{b,Rd}$ $\Sigma F_{v,Ed} \leq N_{net,Rd}$ $\boxed{A_1} \Sigma F_{v,Ed} \leq N_{net,Rd,ser} \boxed{A_1}$	Preloaded high strength bolts. No slip at the ultimate limit state. $N_{net,Rd} = 0,9A_{net}f_u / \gamma_{M2}$ $N_{net,Rd,ser} = A_{net}f_o / \gamma_{M1}$
Tension connections		
Category	Criterion	Remarks
D; non-preloaded	$F_{t,Ed} \leq F_{t,Rd}$ $F_{t,Ed} \leq B_{p,Rd}$	Bolt class from 4.6 to 10.9.
E; preloaded	$F_{t,Ed} \leq F_{t,Rd}$ $F_{t,Ed} \leq B_{p,Rd}$	Preloaded 8.8 or 10.9 bolts.
Key: $F_{v,Ed}$ design shear force per bolt for the ultimate limit state $F_{v,Ed,ser}$ design shear force per bolt for the serviceability limit state $F_{v,Rd}$ design shear resistance per bolt $F_{b,Rd}$ design bearing resistance per bolt $F_{s,Rd,ser}$ design slip resistance per bolt at the serviceability limit state $F_{s,Rd}$ design slip resistance per bolt at the ultimate limit state $F_{t,Ed}$ design tensile force per bolt for the ultimate limit state $F_{t,Rd}$ design tension resistance per bolt A_{net} net area, see 6.2.2.2 (tension members only) $B_{p,Rd}$ design resistance for punching resistance, see Table 8.5.		

(2) **Category A: Bearing type**

In this category protected steel bolts (ordinary or high strength type) or stainless steel bolts or aluminium bolts or aluminium rivets should be used. No preloading and special provisions for contact surfaces are required.

$\boxed{A_1}$ Text deleted $\boxed{A_1}$

(3) **Category B: Slip-resistant at serviceability limit state**

In this category preloaded high strength bolts with controlled tightening in conformity with $\boxed{A_1}$ EN 1090-3 $\boxed{A_1}$ should be used. Slip should not occur at the serviceability limit state. The combination of actions to be considered should be selected from 2.3.4 depending on the load cases where resistance to slip is required. The design serviceability shear load should not exceed the design slip resistance, obtained from 8.5.9.

$\boxed{A_1}$ Text deleted $\boxed{A_1}$

(4) **Category C: Slip resistant at ultimate limit state**

In this category preloaded high strength bolts with controlled tightening in conformity with EN 1090-3 should be used. Slip should not occur at the ultimate limit state. *Text deleted*

(5) In addition, at the ultimate limit state the design plastic resistance of the net section at bolt holes $N_{\text{net,Rd}}$ should be taken as:

$$N_{\text{net,Rd}} = 0,9 A_{\text{net}} f_u / \gamma_{M2} \quad (8.6)$$

8.5.3.2 Tension connections

(1) The design of a bolted connection loaded in tension should conform with one of the following categories, see Table 8.4.

(2) Category D: Connections with non-preloaded bolts

In this category bolts from class 4.6 up to and including class 10.9 or aluminium bolts or stainless steel bolts should be used. No preloading is required. This category should not be used where the connections are frequently subjected to variations of tensile loading. However, they may be used in connections designed to resist normal wind loads.

(3) Category E: Connections with preloaded high strength bolts

In this category preloaded high strength bolts with controlled tightening in conformity with EN 1090-3 should be used. Such preloading improves fatigue resistance. However, the extent of the improvement depends on detailing and tolerances.

(4) For tension connections of both categories D and E no special treatment of contact surfaces is necessary, except where connections of category E are subject to both tension and shear (combination E-B or E-C).

8.5.4 Distribution of forces between fasteners

(1) The distribution of internal forces between fasteners due to the bending moment at the ultimate limit state should be proportional to the distance from the centre of rotation and the distribution of the shear force should be equal, see Figure 8.7(a), in the following cases:

- category C slip-resistant connections;
- other shear connections where the design shear resistance $F_{v,Rd}$ of a fastener is less than the design bearing resistance $F_{b,Rd}$.

(2) In other cases the distribution of internal forces between fasteners due to the bending moment at the ultimate limit state may be assumed plastic and the distribution of the shear force may be assumed equal, see Figure 8.7(b).

(3) In a lap joint, the same bearing resistance in any particular direction should be assumed for each fastener up to a maximum length of $\max L = 15 d$, where d is the nominal diameter of the bolt or rivet. For $L > 15 d$ see 8.5.11.

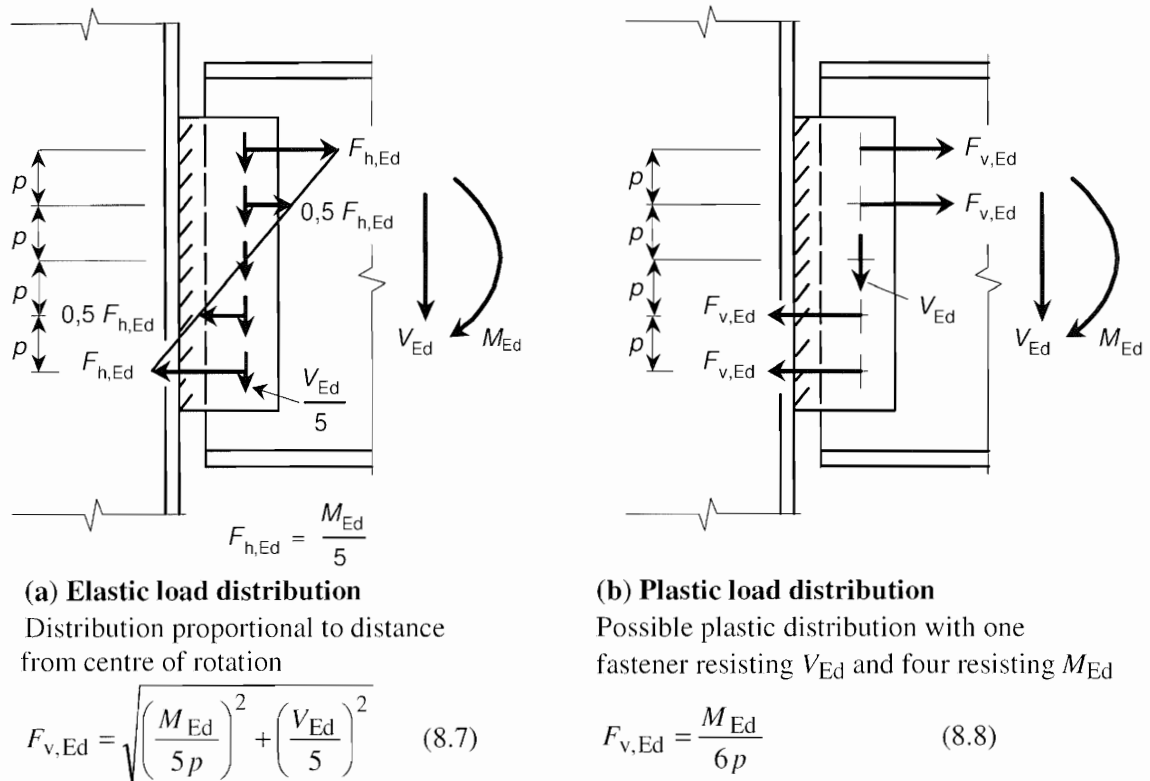

Figure 8.7 - Example of distribution of loads between fasteners (five bolts)

8.5.5 Design resistances of bolts

(1) The design resistances given in this clause apply to standard manufactured steel bolts, stainless steel bolts and aluminium bolts according to Table 3.4 which conform, including corresponding nuts and washers, to the reference standards listed in [A1] EN 1090-3 [A1]. For aluminium bolts the additional requirements of C.4.1 should be followed.

(2)P At the ultimate limit state the design shear force $F_{v,Ed}$ on a bolt shall not exceed the lesser of:

- the design shear resistance $F_{v,Rd}$;
- the design bearing resistance $F_{b,Rd}$ of that bolt with the minimum bearing capacity of the connection, both as given in Table 8.5.

(3)P At the ultimate limit state the design tensile force $F_{t,Ed}$, inclusive of any force due to prying action, shall not exceed the design tension resistance $B_{t,Rd}$ of the bolt-plate assembly.

(4) Bolts subject to both shear force and tensile force should in addition be verified as given in Table 8.5.

(5)P The design tension resistance of the bolt-plate assembly $B_{t,Rd}$ shall be taken as the smaller of the design tension resistance $F_{t,Rd}$ of the bolt given in Table 8.5 and the design punching shear resistance of the bolt head and the nut in the plate, $B_{p,Rd}$ obtained from Table 8.5.

Table 8.5 - Design resistance for bolts and rivets

Failure mode	Bolts	Rivets
Shear resistance per shear plane:	$F_{v,Rd} = \frac{\alpha_v f_{ub} A}{\gamma_{M2}} \quad (8.9)$ <ul style="list-style-type: none"> - where the shear plane passes through the threaded portion of the bolt (A is the tensile stress area of the bolt A_S): - for steel bolts with classes 4.6, 5.6 and 8.8: $\alpha_v = 0,6$ - for steel bolts with classes 4.8, 5.8, 6.8 and 10.9, stainless steel bolts and aluminium bolts: $\alpha_v = 0,5$ <hr/> <ul style="list-style-type: none"> - where the shear plane passes through the unthreaded portion of the bolt (A is the gross cross section of the bolt): $\alpha_v = 0,6$ f_{ub} = characteristic ultimate strength of the bolt material 	$F_{v,Rd} = \frac{0,6 f_{ur} A_0}{\gamma_{M2}} \quad (8.10)$ <p>f_{ur} = characteristic ultimate strength of the rivet material A_0 = cross sectional area of the hole</p>
Bearing resistance 1) 2) 3) 4) 5) 6)	$F_{b,Rd} = \frac{k_1 \alpha_b f_u d t}{\gamma_{M2}} \quad (8.11)$ <p>where α_b is the smallest of α_d or $\frac{f_{ub}}{f_u}$ or 1,0; but $\leq 0,66$ for slotted holes</p> <p>in the direction of the load transfer:</p> <ul style="list-style-type: none"> - for end bolts: $\alpha_d = \frac{e_1}{3d_0}$; for inner bolts: $\alpha_d = \frac{p_1}{3d_0} - \frac{1}{4}$; (8.13 and 8.14) <p>perpendicular to the direction of the load transfer:</p> <ul style="list-style-type: none"> - for edge bolts: k_1 is the smallest of $2,8 \frac{e_2}{d_0} - 1,7$ or 2,5 (8.15) - for inner bolts: k_1 is the smallest of $1,4 \frac{p_2}{d_0} - 1,7$ or 2,5 (8.16) <p>f_u is the characteristic ultimate strength of the material of the connected parts f_{ub} is the characteristic ultimate strengths of the bolt material d is the bolt diameter d_0 is the hole diameter e_1, e_2, p_1, p_2 see Figure 8.1⁵⁾</p>	
Tension resistance	$F_{t,Rd} = \frac{k_2 f_{ub} A_s}{\gamma_{M2}} \quad (8.17)$ <p>where $k_2 = 0,9$ for steel bolts, $k_2 = 0,50$ for aluminium bolts and $k_2 = 0,63$ for countersunk steel bolts,</p>	$F_{t,Rd} = \frac{0,6 f_{ur} A_0}{\gamma_{M2}} \quad (8.18)$ <p>For solid rivets with head dimensions according to Annex C, Figure C.1 or greater on both sides.</p>
Punching shear resistance	$B_{p,Rd} = 0,6 \pi d_m t_p f_u / \gamma_{M2} \quad (8.19)$ <p>where:</p> <p>d_m is the mean of the across points and across flats dimensions of the bolt head or the nut or if washers are used the outer diameter of the washer, whichever is smaller;</p> <p>t_p is the thickness of the plate under the bolt head or the nut;</p> <p>f_u characteristic ultimate strength of the member material.</p>	
Combined shear and tension	$\frac{F_{v,Ed}}{F_{v,Rd}} + \frac{F_{t,Ed}}{1,4 F_{t,Rd}} \leq 1,0 \quad (8.20)$	

- 1) The bearing resistance $F_{b,Rd}$ for bolts
 - in oversized holes according to A1 EN 1090-3 A1 is 0,8 times the bearing resistance for bolts in normal holes,
 - in short slotted holes, where the longitudinal axis of the slotted hole is perpendicular to the direction of the force transfer and the length of the slotted hole is not more than 1,5 times the diameter of the round part of the hole, is 0,80 times the bearing resistance for bolts in round, normal holes.
 - in long slotted holes, where the longitudinal axis of the slotted hole is perpendicular to the direction of the force transfer and the length of the slotted hole is between 1,5 times the hole diameter and 2,5 times the hole diameter of the round part of the hole, is 0,65 times the bearing resistance for bolts in round, normal holes.
- 2) For countersunk bolts:
 - the bearing resistance $F_{b,Rd}$ should be based on a plate thickness t equal to the thickness of the connected plate minus half the depth of the countersinking,
- 3) In addition to bearing resistance, the net section resistance needs to be checked
- 4) If the load on a bolt is not parallel to the edge, the bearing resistance may be verified separately for the bolt load components parallel and normal to the end.
- 5) Aluminium bolts should not be used in connections with slotted holes.
- 6) For slotted holes replace d_0 by $(d + 1 \text{ mm})$, e_1 by $(e_3 + d/2)$, e_2 by $(e_4 + d/2)$, p_1 by $(p_3 + d)$ and p_2 by $(p_4 + d)$ where p_3 , p_4 , e_3 and e_4 are found in Figure 8.4.

(6) The design resistances for tension and for shear through the threaded portion given in Table 8.5 are restricted to bolts with rolled threads. A1 For bolts with cut threads, the relevant values from Table 8.5 should be reduced by multiplying them by a factor of 0,85. A1

A1 (7) The values for design shear resistance $F_{v,Rd}$ given in Table 8.5 apply only where the bolts are used in holes with nominal clearances not exceeding those for standard holes as specified in EN 1090-3. For oversized holes and slotted holes $F_{v,Rd}$ is reduced by a factor of 0,7. A1

8.5.6 Design resistance of rivets

(1) Riveted connections should be designed to transfer forces in shear and bearing. The design resistances in this clause apply to aluminium rivets acc. to Table 3.4. The additional requirements of C.4.2 should be followed

(2)P At the ultimate limit state the design shear force $F_{v,Ed}$ on a rivet shall not exceed the lesser of:

- the design shear resistance $F_{v,Rd}$
- the design bearing resistance $F_{b,Rd}$

both as given in Table 8.5.

(3) Tension in aluminium rivets should be limited to exceptional cases (see Table 8.5).

(4)P At the ultimate limit state the design tension force $F_{t,Ed}$ on a rivet shall not exceed the design ultimate tension resistance $F_{t,Rd}$ as given in Table 8.5.

(5) Rivets subject to both shear and tensile forces should in addition satisfy the requirement for combined shear and tension as given in Table 8.5.

A1 Text deleted A1

(6) As a general rule, the grip length of a rivet should not exceed $4,5d$ for hammer riveting and $6,5d$ for press riveting.

(7) Single rivets should not be used in single lap joints.

8.5.7 Countersunk bolts and rivets

(1) Connections with countersunk bolts or rivets made from steel should be designed to transfer forces in shear and bearing.

(2)P At the ultimate limit state the design shear force $F_{v,Ed}$ on a countersunk bolt or rivet made from steel shall not exceed the lesser of:

- 0,7 times the design shear resistance $F_{v,Rd}$ as given in Table 8.5 and
- the design bearing resistance $F_{b,Rd}$, which should be calculated as specified in 8.5.5 or 8.5.6 respectively, with half the depth of the countersink deducted from the thickness t of the relevant part jointed.

(3) Tension in a countersunk bolt made from steel should be designed to transfer tension force $F_{t,Ed}$. It should be limited to exceptional cases (see Table 8.5).

(4)P At the ultimate limit state the design tension force $F_{t,Ed}$ on a countersunk bolt made from steel shall not exceed the design ultimate tension resistance $F_{t,Rd}$ as given in Table 8.5.

(5) Bolts and rivets subject to both shear and tensile forces should in addition satisfy the requirement for combined shear and tension as given in Table 8.5.

(6) The angle and depth of countersinking should conform with EN 1090-3 .

~~Text deleted~~

(7) As a general rule, the grip length of a countersunk bolt or rivet should not exceed 4,5 d for hammer riveting and 6,5 d for press riveting.

(8) Single countersunk bolts or rivets should not be used in single lap joints.

8.5.8 Hollow rivets and rivets with mandrel

(1) For the design strength of hollow rivets and rivets with mandrel, see EN 1999-1-4.

8.5.9 High strength bolts in slip-resistant connections

8.5.9.1 General

(1) Slip resistant connections should only be used if the proof strength of the material of the connected parts is higher than 200 N/mm².

(2) The effect of extreme temperature changes and/or long grip lengths which may cause a reduction or increase of the friction capacity due to the differential thermal expansion between aluminium and bolt steel cannot be ignored.

8.5.9.2 Ultimate limit state

(1)P It is possible to take the slip resistance as ultimate or serviceability limit state, see 8.5.3.1, but, besides, at the ultimate limit state the design shear force, $F_{v,Ed}$ on a high strength bolt shall not exceed the lesser of:

- the design shear resistance $F_{v,Rd}$
- the design bearing resistance $F_{b,Rd}$
- the tensile ~~text deleted~~ resistance of the member in the net section and in the gross cross section.

8.5.9.3 Slip resistance / Shear resistance

(1) The design slip resistance of a preloaded high-strength bolt should be taken as:

$$F_{s,Rd} = \frac{n\mu}{\gamma_{Ms}} F_{p,C} \quad (8.21)$$

where:

- $F_{p,C}$ is the preloading force, given in 8.5.9.4.
- μ is the slip factor, see 8.5.9.5 and
- n is the number of friction interfaces.

(2) For bolts in standard nominal clearance holes, the partial safety factor for slip resistance γ_{Ms} should be taken as $\gamma_{Ms,ult}$ for the ultimate limit state and $\gamma_{Ms,ser}$ for the serviceability limit state where $\gamma_{Ms,ult}$ and $\gamma_{Ms,ser}$ are given in 8.1.1.

If the slip factor μ is found by tests the partial safety factor for the ultimate limit state may be reduced by 0,1.

(3) Slotted or oversized holes are not covered by these clauses.

8.5.9.4 Preloading

(1) For high strength bolts grades 8.8 or 10.9 with controlled tightening, the preloading force $F_{p,C}$ to be used in the design calculations, should be taken as:

$$F_{p,C} = 0,7 f_{ub} A_s \quad (8.22)$$

8.5.9.5 Slip factor

(1) The design value of the slip factor μ is dependent on the specified class of surface treatment. The value of μ for grit blasting to achieve a roughness value R_a 12,5, see EN ISO 1302 and EN ISO 4288, without surface protection treatments, should be taken from Table 8.6.

Table 8.6 - Slip factor of treated friction surfaces

Total joint thickness mm	Slip factor μ
$12 \leq \Sigma t < 18$	0,27
$18 \leq \Sigma t < 24$	0,33
$24 \leq \Sigma t < 30$	0,37
$30 \leq \Sigma t$	0,40

NOTE Experience show that surface protection treatments applied before shot blasting lead to lower slip factors.

(2) The calculations for any other surface treatment or the use of higher slip factors should be based on specimens representative of the surfaces used in the structure using the procedure set out in [EN 1090-3 A1](#).

8.5.9.6 Combined tension and shear

(1) If a slip-resistant connection is subjected to an applied tensile force F_t in addition to the shear force F_v tending to produce slip, the slip resistance per bolt should be taken as follows:

Category B: Slip-resistant at serviceability limit state

$$F_{s,Rd,ser} = \frac{n \mu (F_{p,C} - 0,8 F_{t,Ed,ser})}{\gamma_{Ms,ser}} \quad (8.23)$$

Category C: Slip-resistant at ultimate limit state

$$F_{s,Rd} = \frac{n \mu (F_{p,C} - 0,8F_{t,Ed})}{\gamma_{Ms,ult}} \quad (8.24)$$

8.5.10 Prying forces

(1) Where fasteners are required to carry an applied tensile force, they should be proportioned to also resist the additional force due to prying action, where this can occur, see Figure 8.8.

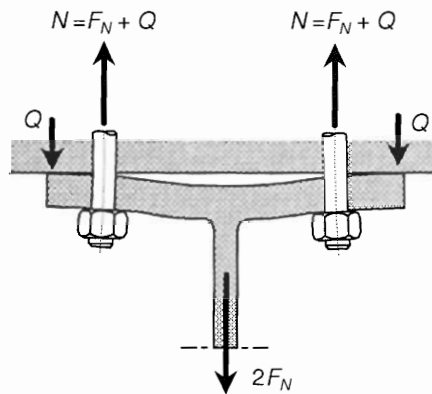

Figure 8.8 - Prying forces (Q)

(2) The prying forces depend on the relative stiffness and geometrical proportions of the parts of the connection, see Figure 8.9.

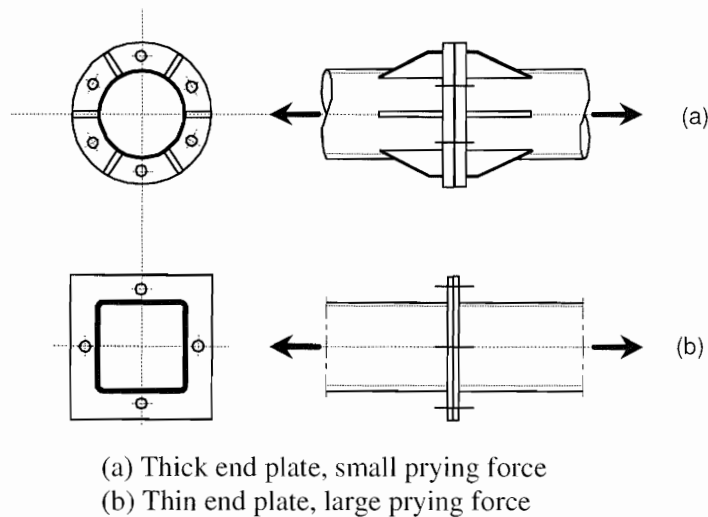

Figure 8.9 - Effect of details on prying forces

(3) If the effect of the prying force is taken advantage of in the design of the end plates, then the prying force should be allowed for in the analysis. See Annex B.

8.5.11 Long joints

(1) Where the distance L_j between the centres of the end fasteners in a joint, measured in the direction of the transfer of force (see Figure 8.10), is more than $15d$, the design shear resistance $F_{v,Rd}$ of all the fasteners calculated as specified in 8.5.5 or 8.5.6 as appropriate should be reduced by multiplying it by a reduction factor β_{Lf} , given by:

$$\beta_{Lf} = 1 - \frac{L_j - 15d}{200d} \quad (8.25)$$

but $0,75 \leq \beta_{L,f} \leq 1,0$.

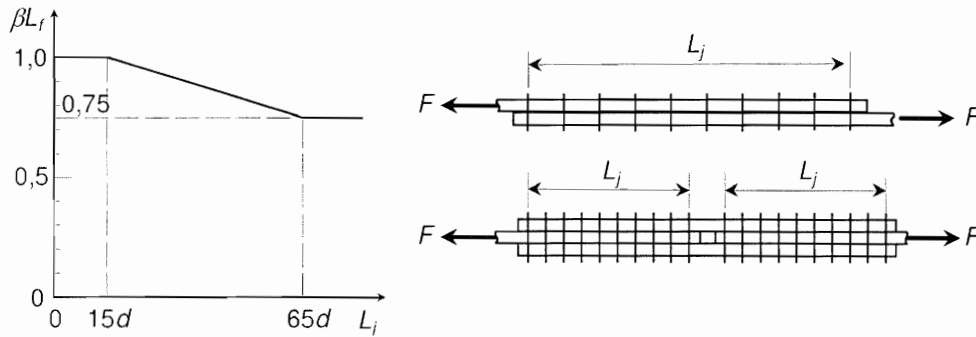

Figure 8.10 - Long joints

(2) This provision does not apply where there is a uniform distribution of force transfer over the length of the joint, e.g. the transfer of shear force from the web of a section to the flange.

8.5.12 Single lap joints with fasteners in one row

(1) A single rivet or one row of rivets should not be used in single lap joints.

(2) The bearing resistance $F_{b,Rd}$ determined in accordance with 8.5.5 should be limited to:

$$F_{b,Rd} \leq 1,5 f_u d t / \gamma_{M2} \quad (8.26)$$

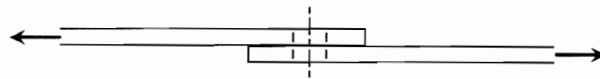

Figure 8.11 - Single lap joint with one row of bolts

(3) In the case of high strength bolts, grades 8.8 or 10.9, appropriate washers should be used for single lap joints of flats with only one bolt or one row of bolts (normal to the direction of load), even where the bolts are not preloaded.

8.5.13 Fasteners through packings

(1) Where bolts or rivets transmitting load in shear and bearing pass through packings of total thickness t_p greater than one-third of the nominal diameter d , the design shear resistance $F_{v,Rd}$ calculated as specified in 8.5.5 or 8.5.6 as appropriate, should be reduced by multiplying it by a reduction factor β_p given by:

$$\beta_p = \frac{9d}{8d + 3t_p} \quad \text{but } \beta_p \leq 1,0 \quad (8.27)$$

(2) For double shear connections with packings on both sides of the splice, t_p should be taken as the thickness of the thicker packing.

(3) Any additional fasteners required due to the application of the reduction factor β_p may optionally be placed in an extension of the packing.

8.5.14 Pin connections

8.5.14.1 A1 General

(1) Pin connections where rotation is required should be designed according to 8.5.14.2 – 8.5.14.3.

(2) Pin connections in which no rotation is required may be designed as single bolted connections, provided that the length of the pin is less than 3 times the diameter of the pin, see 8.5.3. For all other cases the method in 8.5.14.3 should be followed. A1

8.5.14.2 Pin holes and pin plates

- Ⓐ) (1) The geometry of plates in pin connections should be in accordance with the dimensional requirements, see Figure 8.12.

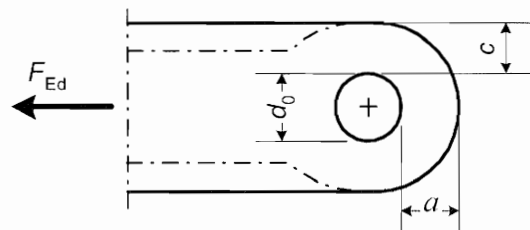

a) Given thickness and diameter of hole

$$a \geq \frac{F_{Ed} \gamma_{M1}}{2t f_0} + \frac{2d_0}{3}$$

$$c \geq \frac{F_{Ed} \gamma_{M1}}{2t f_0} + \frac{d_0}{3}$$

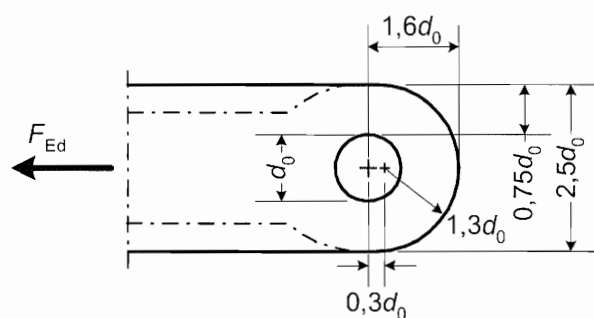

b) Given geometry

$$t \geq 0,7 \sqrt{\frac{F_{Ed} \gamma_{M1}}{f_0}}$$

$$d_0 \geq 1,75 \sqrt{\frac{F_{Ed} \gamma_{M1}}{f_0}}$$

t = thickness of member (plate)
 d_0 = diameter of hole

Figure 8.12 - Geometrical requirements for pin ended members

- (2)P At the ultimate limit state the design force F_{Ed} in the plate shall not exceed the design resistance given in Table 8.7.

- (3) Pin plates provided to increase the net area of a member or to increase the bearing resistance of a pin should be of sufficient size to transfer the design force from the pin into the member and should be arranged to avoid eccentricity. Ⓐ)

8.5.14.3 Design of pins

- Ⓐ) (1) Pins should not be loaded in single shear, so one of the members to be joined should have a fork end, or clevis. The pin retaining system, e.g. spring clip, should be designed to withstand a lateral load not less than 10% of the total shear load of the pin.

- (2) The bending moments in a pin should be calculated as indicated in Figure 8.13.

- (3) At the ultimate limit state the design forces and moments in a pin should not exceed the relevant design resistances given in Table 8.7.

- (4) If the pin is intended to be replaceable (multiple assembling and disassembling of a structure), in addition the provisions given in 8.5.14.2 and 8.5.14.3 the contact bearing stress should satisfy:

$$\sigma_{h,Ed} \leq f_{h,Rd} \quad (8.28a)$$

where:

$$\sigma_{h,Ed} = 0,591 \sqrt{\frac{F_{Ed,ser}(d_0 - d)}{d^2 t}} \sqrt{\frac{2E_p E_{pl}}{E_p + E_{pl}}} \quad (8.28b)$$

$$f_{h,Rd} = 2,5 f_0 / \gamma_{M6,ser}$$

where:

d is the diameter of the pin Ⓐ)

d_0 is the diameter of the pin hole

$F_{Ed,ser}$ is the design value of the force to be transferred in bearing under the characteristic load combination for serviceability limit state

E_p, E_{pl} is the elastic modulus of the pin and the plate material respectively.

Table 8.7 - Design resistances for pin connections

Criterion	Resistance
Shear of the pin	$F_{v,Rd} = 0,6 A f_{up} / \gamma_{Mp} \geq F_{v,Ed}$
If the pin is intended to be replaceable this requirement should also be satisfied	$F_{v,Rd,ser} = 0,6 A f_{op} / \gamma_{M6,ser} \geq F_{v,Ed,ser}$
Bearing of the plate and the pin	$F_{b,Rd} = 1,5 t d f_{o,min} / \gamma_{M1} \geq F_{b,Ed}$
If the pin is intended to be replaceable this requirement should also be satisfied	$F_{b,Rd} = 0,6 t d f_o / \gamma_{M6,ser} \geq F_{b,Ed,ser}$
Bending of the pin	$M_{Rd} = 1,5 W_{el} f_{op} / \gamma_{M1} \geq M_{Rd}$
If the pin is intended to be replaceable this requirement should also be satisfied	$M_{Rd} = 0,8 W_{el} f_{op} / \gamma_{M6,ser} \geq M_{Ed,ser}$
Combined shear and bending of the pin	$(M_{Ed} / M_{Rd})^2 + (F_{v,Ed} / F_{v,Rd})^2 \leq 1,0$
d	is the diameter of the pin
$f_{o,min}$	is the lower of the design strengths of the pin and the connected part
f_{up}	is the ultimate tensile strength of the pin
f_{op}	is the yield strength of the pin
t	is the thickness of the connected part
A	is the cross sectional area of a pin.

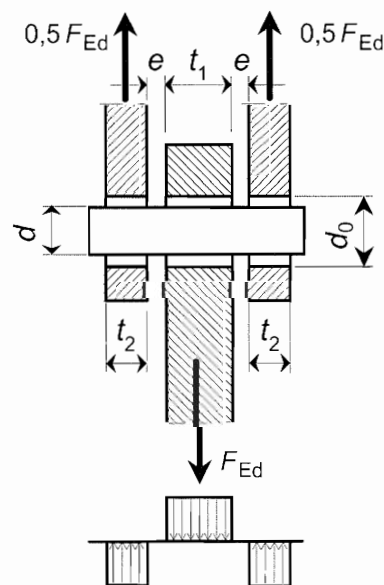

Figure 8.13 - Actions and action effects on a pin

$$M_{Ed} = F_{Ed} (2t_2 + 4e + t_1) / 8$$

(8.28c) \square

8.6 Welded connections

8.6.1 General

(1) In the design of welded joints consideration should be given both to the strength of the welds and to the strength of the HAZ.

(2) The design guidance given here applies to:

- the welding process MIG and TIG for material thicknesses according to Table 3.2a and Table 3.2b;
 $\overline{A1}$ text deleted $\overline{A1}$
- quality level according to $\overline{A1}$ EN 1090-3 $\overline{A1}$;
- combinations of parent and filler metal as given in 3.3.4;
- structures loaded with predominantly static loads.

(3) If - in case of primary load bearing members - the above conditions are not fulfilled special test pieces should be welded and tested, which should be agreed upon by the contracting parties.

(4) If for secondary or non load-bearing members a lower quality level has been specified lower design strength values should be used.

8.6.2 Heat-affected zone (HAZ)

(1) For the following classes of alloys a heat-affected zone should be taken into account (see also $\overline{A1}$ 6.1.6 $\overline{A1}$):

- heat-treatable alloys in temper T4 and above (6xxx and 7xxx series);
- non-heat-treatable alloys in any work-hardened condition (3xxx, 5xxx and 8xxx series).

(2) The severity and extent (dimensions) of HAZ softening given in $\overline{A1}$ 6.1.6 $\overline{A1}$ should be taken into account. Both severity and extent are different for TIG and MIG welding. For TIG welding a higher extent (larger HAZ area) and more severe softening due to the higher heat-input should be applied.

(3) The characteristic strengths $f_{u,haz}$ for the material in the HAZ are given in Table 3.2. The characteristic shear strength in the HAZ is defined as: $f_{v,haz} = f_{u,haz} / \sqrt{3}$

8.6.3 Design of welded connections

(1) For the design of welded connections the following should be verified:

- the design of the welds, see 8.6.3.2 and 8.6.3.3;
- the design strength of the HAZ adjacent to a weld, see 8.6.3.4;
- the design of connections with combined welds, see 8.6.3.5.

(2) The deformation capacity of a welded joint can be improved if the design strength of the welds is greater than that of the material in the HAZ.

8.6.3.1 Characteristic strength of weld metal

(1) For the characteristic strength of weld metal (f_w) the values according to Table 8.8 should be used, provided that the combinations of parent metal and filler metal as given in 3.3.4, are applied.

(2) In welded connections the strength of the weld metal is usually lower than the strength of the parent metal except for the strength in the HAZ.

Table 8.8 - Characteristic strength values of weld metal f_w

Characteristic strength	Filler metal	Alloy								
		3103	5052	5083	5454	6060	6005A	6061	6082	7020
f_w [N/mm ²]	5356	-	170	240	220	160	180	190	210	260
	4043A	95	-	-	-	150	160	170	190	210

1 For alloys EN AW-5754 and EN AW-5049 the values of alloy 5454 can be used;
 for EN AW-6063, EN AW-3005 and EN AW-5005 the values of alloy 6060 can be used;
 for EN AW-6106 the values of alloy 6005A can be used;
 for EN AW-3004 the values of alloy 6082 can be used;
 for EN AW-8011A a value of 100 N/mm² for filler metal Type 4 and Type 5 can be used.

2 ^(A1)If filler metals 5056, 5356A, 5556A/5556B, 5183/5183A are used ^(A1) then the values for 5356 have to be applied.

3 If filler metals 4047A or 3103 are used then the values of 4043A have to be applied.

4 For combinations of different alloys the lowest characteristic strength of the weld metal has to be used.

(3) The characteristic strength of weld metal should be distinguished according to the filler metal used. The choice of filler metal has a significant influence on the strength of the weld metal.

8.6.3.2 Design of butt welds

8.6.3.2.1 Full Penetration Butt Welds

- (1) Full penetration butt welds should be applied for primary load-bearing members.
- (2) The effective thickness of a full penetration butt weld should be taken as the thickness of the connected members. With different member thicknesses the smallest member thickness should be taken as weld thickness.
- (3) Reinforcement or undercut of the weld within the limits as specified should be neglected for the design.
- (4) The effective length should be taken as equal to the total weld length if run-on and run-off plates are used. Otherwise the total length should be reduced by twice the thickness t .

8.6.3.2.2 Partial Penetration Butt Welds

- (1) Partial penetration butt welds should only be used for secondary and non load-bearing members.
- (2) For partial penetration butt welds an effective throat section t_e should be applied (see Figure 8.21).

8.6.3.2.3 Design Formulae for Butt Welds

(1) For the design stresses the following applies:

- normal stress, tension or compression, perpendicular to the weld axis, see Figure 8.14:

$$\sigma_{LEd} \leq \frac{f_w}{\gamma_{Mw}} \tag{8.29}$$

- shear stress, see Figure 8.15:

$$\supseteq \tau_{Ed} \leq \frac{1}{\sqrt{3}} \frac{f_w}{\gamma_{Mw}} \tag{8.30} \supseteq$$

- combined normal and shear stresses:

$$\sqrt{\sigma_{\perp Ed}^2 + 3\tau_{Ed}^2} \leq \frac{f_w}{\gamma_{Mw}} \quad (8.31)$$

where:

- f_w characteristic strength weld metal according to Table 8.8;
- $\sigma_{\perp Ed}$ normal stress, perpendicular to the weld axis;
- τ_{Ed} shear stress, parallel to the weld axis;
- γ_{Mw} partial safety factor for welded joints, see 8.1.1.

(2) Residual stresses and stresses not participating in the transfer of load need not be included when checking the resistance of a weld. ^[A1] Text deleted ^[A1]

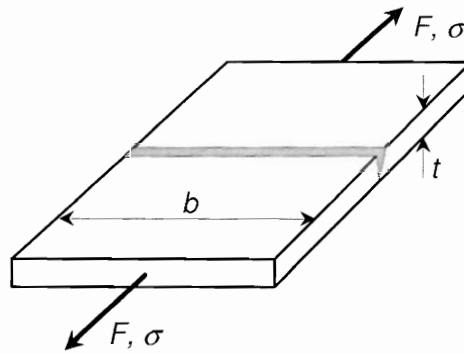

Figure 8.14 - Butt weld subject to normal stresses

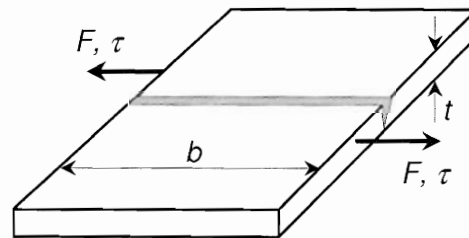

Figure 8.15 - Butt weld subject to shear stresses

8.6.3.3 Design of fillet welds

- (1) For the design of fillet welds the throat section should be taken as the governing section.
- (2) The throat section should be determined by the effective weld length and the effective throat thickness of the weld.
- (3) The effective length should be taken as the total length of the weld if:
 - the length of the weld is at least 8 times the throat thickness;
 - the length of the weld does not exceed 100 times the throat thickness with a non-uniform stress distribution;
 - the stress distribution along the length of the weld is constant for instance in case of lap joints as shown in Figure 8.16a.
- ^[A1] (4) If the length of the weld is less than 8 times the throat thickness the resistance of the weld should not be taken into account. If the stress distribution along the length of the weld is not constant, see Figure 8.16b, and the length of the weld exceeds 100 times the throat thickness the effective weld length of longitudinal welds should be taken as:

$$L_{w,eff} = (1,2 - 0,2 L_w/100 a) L_w \quad \text{with } L_w \geq 100 a \quad (8.32) \supset [A1]$$

A1 where:

- $L_{w,eff}$ = effective length of longitudinal fillet welds
- L_w = total length longitudinal fillet welds
- a = effective throat thickness, see Figure 8.17.

NOTE With non-uniform stress distributions and thin, long welds the deformation capacity at the ends may be exhausted before the middle part of the weld yields; thus the connection fails by a kind of zipper-effect.

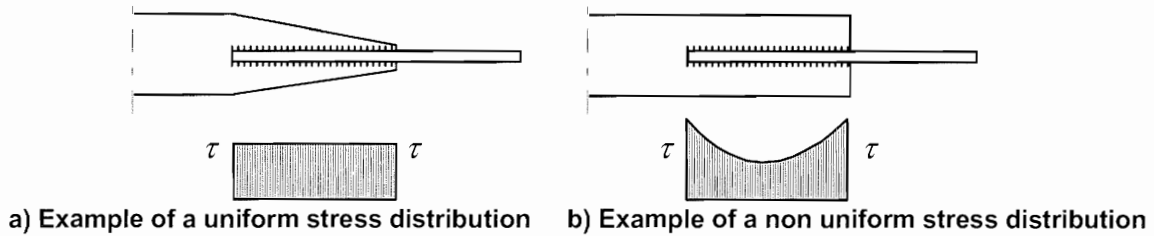

Figure 8.16 - Stress Distributions in Joints with Fillet Welds **A1**

(5) The effective throat thickness a has to be determined as indicated in Figure 8.17 (a the height of the largest triangle which can be inscribed within the weld).

(6) If the qualification specimens show a consistent, positive root penetration, for design purposes the following may be assumed:

- The design throat thickness may be increased by 20% or 2 mm whichever is smaller, under the condition that a qualification procedure has been prepared. Thus: $a = 1,2 a$ or $a = a + 2$ mm.
- With deep penetration fillet welds the additional throat thickness may be taken into account provided that consistent penetration has been proved by test. Thus: $a = a + a_{pen}$, see Figure 8.17.

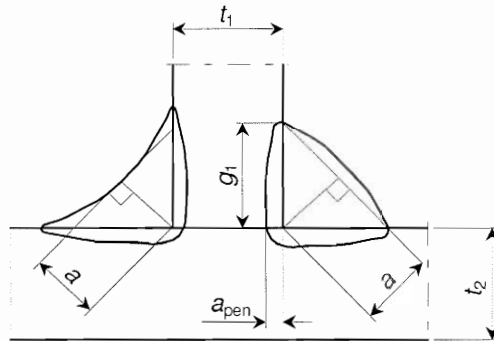

Figure 8.17 - Effective throat thickness a ; positive root penetration a_{pen}

(7) The forces acting on a fillet weld should be resolved into stress components with respect to the throat section, see Figure 8.18. These components are:

- a normal stress σ_{\perp} perpendicular to the throat section;
- a normal stress σ_{\parallel} parallel to the weld axis;
- a shear stress τ_{\perp} acting on the throat section perpendicular to the weld axis;
- a shear stress τ_{\parallel} acting on the throat section parallel to the weld axis.

(8) Residual stresses and stresses not participating in the transfer of load need not be included when checking the resistance of a fillet weld. This applies specifically to the normal stress σ_{\parallel} parallel to the axis of a weld.

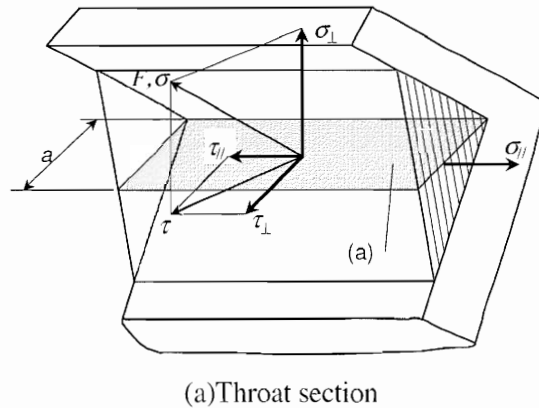

Figure 8.18 - Stresses σ_{\perp} , τ_{\perp} , σ_{\parallel} , and τ_{\parallel} , acting on the throat section of a fillet weld.

(9) The design resistance of a fillet weld should fulfil:

$$\sqrt{\sigma_{\perp Ed}^2 + 3(\tau_{\perp Ed}^2 + \tau_{\parallel Ed}^2)} \leq \frac{f_w}{\gamma_{Mw}} \quad (8.33)$$

where:

- f_w is the characteristic strength of weld metal according to Table 8.8;
- γ_{Mw} is the partial safety factor for welded joints, see 8.1.1.

(10) For two frequently occurring cases the following design formulas, derived from formula (8.33), should be applied:

- Double fillet welded joint, loaded perpendicularly to the weld axis (see Figure 8.19). The throat thickness a should satisfy the following formula:

$$\boxed{A1} \quad a \geq \frac{1}{\sqrt{2}} \frac{\sigma_{Ed} t}{f_w / \gamma_{Mw}} \quad (8.34) \quad \boxed{A1}$$

where:

- $\sigma_{Ed} = \frac{F_{Ed}}{tb}$ normal stress in the connected member; (8.35)
- F_{Ed} design load in the connected member;
- f_w characteristic strength of weld metal according to Table 8.8;
- t thickness of the connected member, see Figure 8.19;
- b width of the connected member.

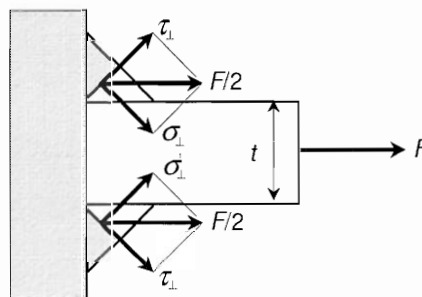

Figure 8.19 - Double fillet welded joint loaded perpendicularly to the weld axis

- Double fillet welded joint, loaded parallel to the weld axis (see Figure 8.20). For the throat thickness a should be applied:

$$\alpha \geq \sqrt{\frac{2}{3}} \frac{\tau_{Ed} t}{f_w / \gamma_{Mw}} \quad (8.36)$$

where:

$$\tau_{Ed} = \frac{F_{Ed}}{t h} \quad \text{shear stress in the connected member;} \quad (8.37)$$

F_{Ed} load in the connected member;

f_w characteristic strength of weld metal according to Table 8.8;

t thickness of the connected member, see Figure 8.20;

h height of the connected member, see Figure 8.20.

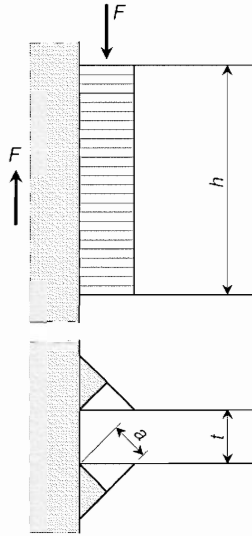

Figure 8.20 - Double fillet welded joint loaded parallel to the weld axis

8.6.3.4 Design resistance in HAZ

(1) The design of a HAZ adjacent to a weld should be taken as follows:

a) Tensile force perpendicular to the failure plane (see Figure 8.21):

- HAZ butt welds:

$$\sigma_{\text{haz,Ed}} \leq \frac{f_{u,\text{haz}}}{\gamma_{Mw}} \quad \text{at the toe of the weld (full cross section) for full penetration welds} \quad (8.38)$$

and effective throat section t_e for partial penetration welds;

- HAZ fillet welds:

$$\sigma_{\text{haz,Ed}} \leq \frac{f_{u,\text{haz}}}{\gamma_{Mw}} \quad \text{at the fusion boundary and at the toe of the weld (full cross section).} \quad (8.39)$$

where:

$\sigma_{\text{haz,Ed}}$ design normal stress perpendicular to the weld axis;

~~Text deleted~~

$f_{u,\text{haz}}$ characteristic strength HAZ, see 8.6.2;

γ_{Mw} partial safety factor for welded joints, see 8.1.1.

b) Shear force in failure plane:

- HAZ butt welds:

$$\tau_{\text{haz,Ed}} \leq \frac{f_{v,\text{haz}}}{\gamma_{Mw}} \quad \text{at the toe of the weld (full cross section) for full penetration welds and effective throat section } t_e \text{ for partial penetration welds} \quad (8.40)$$

- HAZ fillet welds:

$$\tau_{\text{haz,Ed}} \leq \frac{f_{v,\text{haz}}}{\gamma_{Mw}} \quad \text{at the fusion boundary and at the toe of the weld (full cross section)} \quad (8.41)$$

where:

- $\tau_{\text{haz,Ed}}$ shear stress parallel to the weld axis;
- $f_{v,\text{haz}}$ characteristic shear strength HAZ, see 8.6.2;
- γ_{Mw} partial safety factor for welded joints, see 8.1.1.;

c) Combined shear and tension:

- HAZ butt welds:

$$\sqrt{\sigma_{\text{haz,Ed}}^2 + 3\tau_{\text{haz,Ed}}^2} \leq \frac{f_{u,\text{haz}}}{\gamma_{Mw}} \quad \text{at the toe of the weld (full cross section) for full penetration welds and effective throat section } t_e \text{ for partial penetration welds} \quad (8.42)$$

- HAZ fillet welds:

$$\sqrt{\sigma_{\text{haz,Ed}}^2 + 3\tau_{\text{haz,Ed}}^2} \leq \frac{f_{u,\text{haz}}}{\gamma_{Mw}} \quad \text{at the fusion boundary and at the toe of the weld (full cross section)} \quad (8.43)$$

Symbols see 8.6.3.4a) and b).

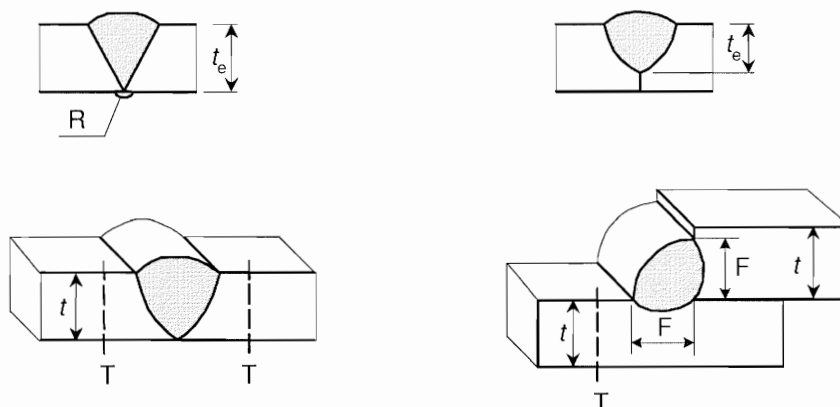

The line F = HAZ in the fusion boundary; the line T = HAZ in toe of the weld, full cross section, t_e = effective throat section, R = root bead

Figure 8.21 - Failure planes in HAZ adjacent to a weld

(2) The above design guidance about HAZ is dealing with welded connections as such. In 6.3 and 6.5 design guidance is given for the effect of HAZ on the structural behaviour of members.

8.6.3.5 Design of connections with combined welds

(1) For the design of connections with combined welds one of the two following methods should be applied (see also 8.1.4):

- Method 1: The loads acting on the joint are distributed to the respective welds that are most suited to carry them.
- Method 2: The welds are designed for the stresses occurring in the adjacent parent metal of the different parts of the joint.

(2) Applying one of the above methods the design of connections with combined welds is reduced to the design of the constituent welds.

(3) With method 1 it has to be checked whether the weld possesses sufficient deformation capacity to allow for such a simplified load distribution. Besides, the assumed loads in the welds should not give rise to overloading of the connected members.

(4) With method 2 the above problems do not exist, but sometimes it may be difficult to determine the stresses in the parent metal of the different parts of the joint.

(5) Assuming a simplified load distribution, like described as method 1, is the most commonly applied method. Since the actual distribution of loads between the welds is highly indeterminate, such assumptions have been found to be an acceptable and satisfactory design practice. However, these assumptions rely on the demonstrated ability of welds to redistribute loads by yielding.

(6) Residual stresses and other stresses not participating in the transfer load need not be considered for the design. For instance, stresses due to minor eccentricities in the joint need not be considered.

8.7 Hybrid connections

(1) If different forms of fasteners are used to carry a shear load or if welding and fasteners are used in combination, the designer should verify that they act together.

(2) In general the degree of collaboration may be evaluated through a consideration of the load-displacement curves of the particular connection with individual kind of joining, or also by adequate tests of the complete hybrid connection.

(3) In particular normal bolts with hole clearance should not collaborate with welding.

(4) Preloaded high-strength bolts in connections designed as slip-resistant at the ultimate limit state (Category C in 8.5.3.1) may be assumed to share load with welds, provided that the final tightening of the bolts is carried out after the welding is complete. The total design load should be given as the sum of the appropriate design resistance of each fastener with its corresponding γ_M -value.

8.8 Adhesive bonded connections

NOTE Recommendations for adhesive bonded connections are given in Annex M.

8.9 Other joining methods

(1) Rules for the design of mechanical fasteners are given in EN 1999-1-4

(2) Other joining methods, which are not covered by the design rules in this standard, may be used provided that appropriate tests in accordance with EN 1990 are carried out in order:

- to demonstrate the suitability of the method for structural application;
- to derive the design resistance of the method used.

(3) Examples of other joining methods are:

- welding methods like for instance friction stir welding and laser welding;
- mechanical fastening methods like screws in screw grooves and self-piercing rivets.

NOTE The National Annex may give provisions for other joining methods.

A1 Annex A [informative] – Reliability differentiation

A.1 Introduction

(1) EN 1990 gives in its section 2 basic requirements to ensure that the structure achieves the required reliability. Its Annex B introduces consequence classes and reliability classes and gives guidelines for the choice of consequence class for the purpose of reliability differentiation. Consequence classes for structural components are divided in three levels noted CC_i ($i = 1, 2$ or 3)

(2) The consequence class and the associated reliability class for a structure or component have implications for the requirements for the design and execution of the structure, and in particular to requirements to design supervision and to inspection of execution.

(3) This annex is a guide for the application of the various parts of EN 1999 and for drafting the execution specification required by EN 1090-3.

A.2 Design provisions for reliability differentiation - Design supervision levels

(1) The guidance in EN 1990, Annex B for reliability differentiation provides:

- rules for design supervision and checking of structural documentation, expressed by Design Supervision Levels;
- rules for determination of design actions and combination of actions, expressed by the partial factors for actions.

NOTE The National Annex may give rules for the application of consequence classes and reliability classes and for the connection between them and requirements for design supervision. Recommendations are given in EN 1990 Annex B.

A.3 Execution provisions for reliability differentiation – Execution classes

(1) Execution classes are introduced in order to differentiate in requirements to structures and their components for reliability management of the execution work, in accordance with EN 1990, clause 2.2 and its informative Annex B.

(2) Aluminium structures are classified in 4 execution classes denoted EXC1, 2, 3 and 4, where class 4 has the most stringent requirements.

NOTE EN 1990 recommends three consequence classes and three reliability classes. EN 1990 does, however, not include structures subject to fatigue that is covered in EN 1999-1-3.

(3) The execution class may apply to the whole structure, to a part of a structure, to one or more components or to specific details. A structure may include more than one execution class.

(4) It is a condition that the execution of structures and structural components is undertaken according to EN 1090-3 following the rules for the various execution classes given in EN 1090-3.

A.4 Governing factors for choice of execution class

(1) The execution class should be selected based on the following three conditions:

- a. the consequences of a structural failure, either human, economical or environmental;
- b. the type of loading, i.e. whether the structure is subject to predominantly static loading or a significant fatigue loading; **A1**

Ⓐ) c. the technology and procedures to be used for the work connected with the requirements for the quality level of the component.

(2) For considerations of the conditions under (a.) by use of consequence classes, see A.1.

(3) The type of uncertainty in exposure and actions (b.) and the complexity in work execution (c.) represent hazards that can impose flaws in the structure leading to its malfunction during use. To consider such hazards service categories and production categories are introduced, see Table A.1 and A.2.

Table A.1: Criteria for service category

Category	Criterion
SC1	Structures subject to quasi static actions ^{a)}
SC2	Structures subject to repeated actions of such intensity that the inspection regime specified for components subject to fatigue is required. ^{b)}
^{a)} Guidance is given in EN 1999-1-3 whether a component or structure may be regarded as subject to quasi static actions and classified in category SC1. ^{b)} Service category SC2 should be used for cases not covered by SC1.	

Table A.2: Criteria for production category

Category	Criterion
PC1	Non welded components
PC2	Welded components

NOTE 1 The determination of the execution class for a structure/component should be taken jointly by the designer and the owner of the construction works, following national provisions in the place of use for the structure. EN 1090-3 requires that the execution class is defined in the execution specification.

NOTE 2 EN 1090-3 gives rules for the execution of work including rules for inspection. The inspection includes in particular rules for welded structures with requirements for quality level, allowable size and kind of weld defects, type and extent of inspection, requirements to supervision and competence of welding supervisors and welding personnel, in relation to the execution class.

Table A.3 gives recommendations for selection of execution class based on the above criteria. In case that no execution class has been specified, it is recommended that execution class EXC2 applies.

A.5 Determination of execution class

(1) The recommended procedure for determination of the execution class is the following:

- a) Determination of consequence class, expressed in terms of predictable consequences of a failure or collapse of a component, see EN 1990;
- b) determination of service category and production category, see Table A.1 and A.2;
- c) determination of execution class from the results of the operations a) and b) in accordance with the recommended matrix in Table A.3. Ⓐ)

Table A.3 Determination of execution class

Consequence class		CC1		CC2		CC3	
Service category		SC1	SC2	SC1	SC2	SC1	SC2
Production category	PC1	EXC1	EXC1	EXC2	EXC3	EXC3 ^{a)}	EXC3 ^{a)}
	PC2	EXC1	EXC2	EXC2	EXC3	EXC3 ^{a)}	EXC4

^{a)} EXC4 should be applied to special structures or structures with extreme consequences of a structural failure also in the indicated categories as required by national provisions.

A.6 Utilization grades

(1) Utilization grades are used to determine requirements to the amount of inspection and to the acceptance criteria for welds, see EN 1090-3.

(2) The utilization grade U for structures and components subject to predominantly static loading is defined by

$$U = \frac{E_k \gamma_F}{R_k / \gamma_M} \quad (\text{A.1})$$

where:

E_k is the characteristic action effect;

R_k is the characteristic resistance.

For combined actions U is given by the interaction formulae.

(3) The utilization grade for structures and components subject to fatigue loads is defined in EN 1999-1-3. ^(A1)

Annex B [normative] - Equivalent T-stub in tension

B.1 General rules for evaluation of resistance

(1) In bolted connections an equivalent T-stub may be used to model the resistance of the basic components of several structural systems (for instance beam-to-column joints), rather than as a stand alone connection as indicated in Figure 8.8.

(2) The possible modes of failure of the flange of an equivalent T-stub may be assumed to be similar to those expected to occur in the basic component that it represents, see Figure B.1.

(3) The total effective length Σl_{eff} of an equivalent T-stub should be such that the resistance of its flange is equivalent to that of the basic joint component that it represents, see Figure B.5.

NOTE The effective length of an equivalent T-stub is a notional length and does not necessarily correspond to the physical length of the basic joint component that it represents.

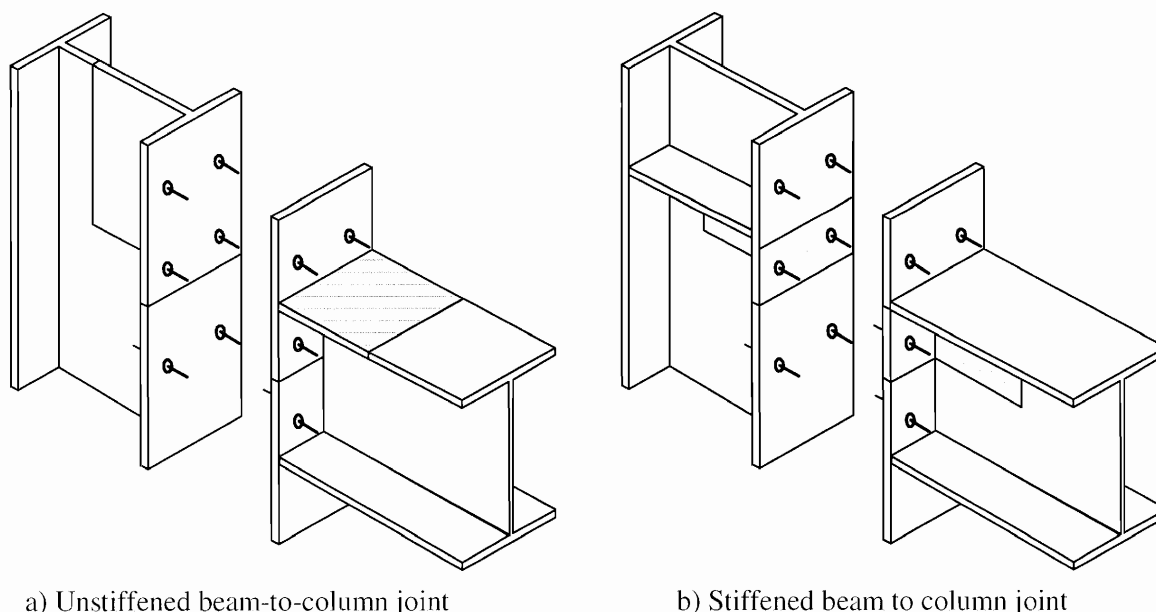

Figure B.1 - T-stub as basic component of other structural systems

(4) In cases where prying forces may develop, see 8.5.10 of EN 1999-1-1, the tension resistance of a T-stub flange $F_{u,Rd}$ should be taken as the smallest value for the four possible failure modes (see Figure B.2) and has to be determined as follows (generally in bolted beam-to-column joints or beam splices it may be assumed that prying forces will develop):

- Mode 1: Flange failure by developing four hardening plastic hinges, two of which are at the web-to-flange connection (w) and two at the bolt location (b):

$$F_{u,Rd} = \frac{2(M_{u,1})_w + 2(M_{u,1})_b}{m} \quad (\text{B.1})$$

In the formula, $(M_{u,1})_w$ should be evaluated according to (B.5) with $\rho_{u,haz} < 1$, while $(M_{u,1})_b$ with $\rho_{u,haz} = 1$ and considering the net area.

- Mode 2a: Flange failure by developing two hardening plastic hinges with bolt forces at the elastic limit:

$$F_{u,Rd} = \frac{2M_{u,2} + n \sum B_o}{m + n} \quad (\text{B.2})$$

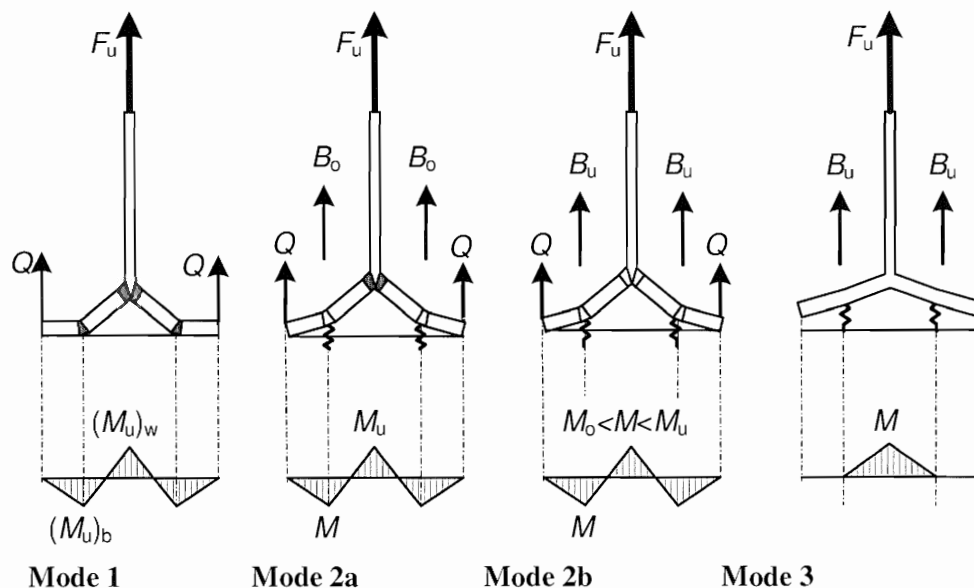

Figure B.2 - Failure modes of equivalent T-stub

- Mode 2b: Bolt failure with yielding of the flange at the elastic limit:

$$F_{u,Rd} = \frac{2M_{o,2} + n \sum B_u}{m + n} \quad (\text{B.3})$$

- Mode 3: Bolt failure:

$$F_{u,Rd} = \sum B_u \quad (\text{B.4})$$

with

$$M_{u,1} = 0,25 \cdot t_f^2 \cdot \sum (l_{\text{eff},1} \rho_{u,\text{haz}} f_u) \cdot \frac{1}{k} \cdot \frac{1}{\gamma_{M1}} \quad (\text{if no weld in a section, set } \rho_{u,\text{haz}} = 1) \quad (\text{B.5})$$

$$M_{u,2} = 0,25 \cdot t_f^2 \cdot \sum (l_{\text{eff},2} \rho_{u,\text{haz}} f_u) \cdot \frac{1}{k} \cdot \frac{1}{\gamma_{M1}} \quad (\text{if no weld in a section, set } \rho_{u,\text{haz}} = 1) \quad (\text{B.6})$$

$$M_{o,2} = 0,25 \cdot t_f^2 \cdot \sum (l_{\text{eff},2} \rho_{o,\text{haz}} f_o) \cdot \frac{1}{\gamma_{M1}} \quad (\text{if no weld in a section, set } \rho_{o,\text{haz}} = 1) \quad (\text{B.7})$$

$$n = e_{\min} \quad \text{but} \quad n \leq 1,25 m$$

$$\frac{1}{k} = \frac{f_o}{f_u} \left(1 + \psi \frac{f_u - f_o}{f_o} \right) \quad (\text{B.8})$$

$$\psi = \frac{\epsilon_u - 1,5 \cdot \epsilon_o}{1,5 \cdot (\epsilon_u - \epsilon_o)} \quad (\text{B.9})$$

$$\epsilon_o = \frac{f_o}{E}$$

where:

ϵ_u is the ultimate strain of the flange material;

B_u is the tension resistance $B_{t,Rd}$ of a bolt-plate assembly given in 8.5.5;

$$B_0 \text{ is the conventional bolt strength at elastic limit} = \begin{cases} \frac{0,9 \cdot f_y \cdot A_s}{\gamma_{M2}} & \text{for steel bolts} \\ \frac{0,6 \cdot f_o \cdot A_s}{\gamma_{M2}} & \text{for aluminium bolts} \end{cases} \quad (\text{B.10})$$

where:

- A_s is the stress area of bolt;
- ΣB_u is the total value of B_u for all the bolts in the T-stub;
- $l_{eff,1}$ is the value of l_{eff} for mode 1;
- $l_{eff,2}$ is the value of l_{eff} for mode 2;
- e_{min} and m are as indicated in Figure B.3;

NOTE In absence of more precise data, for ϵ_u use the minimum guaranteed value A_{50} given in Section 3.

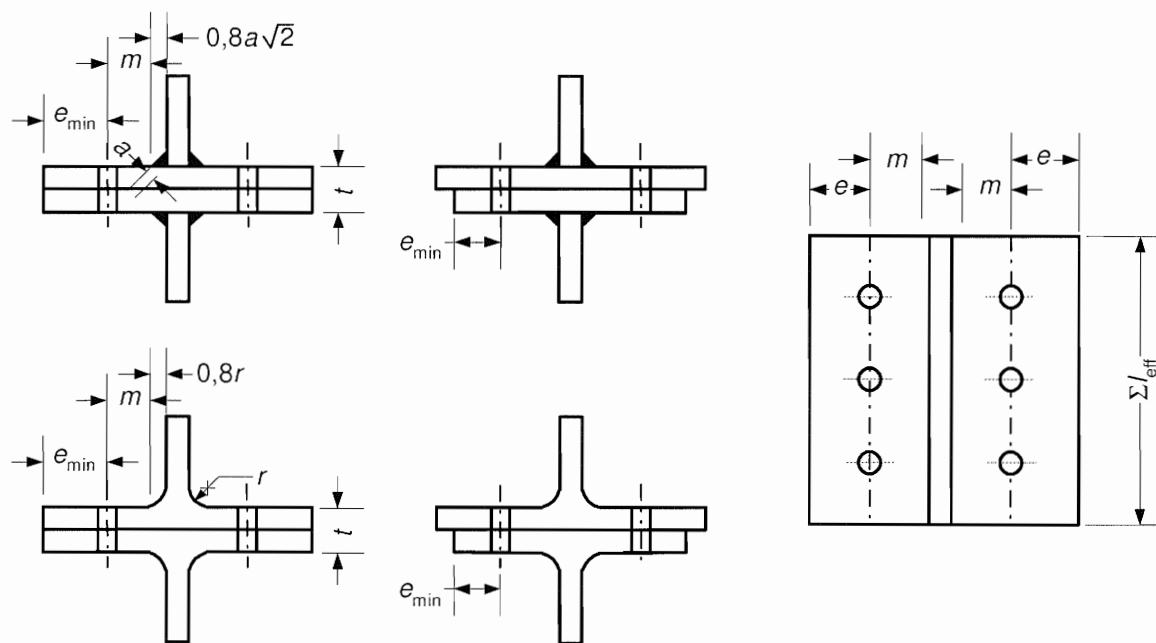

Figure B.3 - Dimensions of an equivalent T-stub.

(5) In case where prying forces may not develop (failure mode 3), the tension resistance of a T-stub flange $F_{u,Rd}$ should be taken as the smallest value, determined as follows:

- Mode 1: Flange failure:

$$F_{u,Rd} = \frac{2M_{u,1}}{m} \quad (\text{B.11})$$

- Mode 3: Bolt failure:

$$F_{u,Rd} = \Sigma B_u \quad (\text{B.12})$$

where $M_{u,1}$, m and ΣB_u are defined in (4).

(6) Methods for determination effective lengths l_{eff} for the individual bolt-rows and the bolt-group, for modeling basic components of a joint as equivalent T-stub flanges, are given in:

- Table B.1 for a T-stub with unstiffened flanges;
- Table B.2 for T-stub with stiffened flanges;

where the dimension e_{min} and m are as indicated in Figure B.3, while the factor α of Table B.2 is given in Figure B.4.

Table B.1 - Effective length for unstiffened flanges

Bolt-row location	Bolt-row considered individually		Bolt-row considered as part of a group of bolt-rows	
	Circular patterns $l_{eff,cp}$	Non-circular patterns $l_{eff,np}$	Circular patterns $l_{eff,cp}$	Non-circular patterns $l_{eff,np}$
Inner bolt-row	$2\pi m$	$4m + 1,25e$	$2p$	p
End bolt-row	The smaller of: $2\pi m$ $\pi m + 2e_1$	The smaller of: $4m + 1,25e$ $2m + 0,625e + e_1$	The smaller of: $\pi m + p$ $2e_1 + p$	The smaller of: $2m + 0,625e + 0,5p$ $e_1 + 0,5p$
Mode 1:	$l_{eff,1} = l_{eff,nc}$ but $l_{eff,1} \leq l_{eff,cp}$		$\Sigma l_{eff,1} = \Sigma l_{eff,nc}$ but $\Sigma l_{eff,1} \leq \Sigma l_{eff,cp}$	
Mode 2:	$l_{eff,1} = l_{eff,nc}$		$\Sigma l_{eff,1} = \Sigma l_{eff,nc}$	
NOTE See figures 8.1 to 8.4. α_1				

Table B.2 - Effective length for stiffened flanges

Bolt-row location	Bolt-row considered individually		Bolt-row considered as part of a group of bolt-rows	
	Circular patterns $l_{eff,cp}$	Non-circular patterns $l_{eff,np}$	Circular patterns $l_{eff,cp}$	Non-circular patterns $l_{eff,np}$
Bolt-row adjacent to a stiffener	$2\pi m$	αm	$\pi m + p$	$0,5p + \alpha m - (2m + 0,625e)$
Other inner bolt-row	$2\pi m$	$4m + 1,25e$	$2p$	p
Other end bolt-row	The smaller of: $2\pi m$ $\pi m + 2e_1$	The smaller of: $4m + 1,25e$ $2m + 0,625e + e_1$	The smaller of: $\pi m + p$ $2e_1 + p$	The smaller of: $2m + 0,625e + 0,5p$ $e_1 + 0,5p$
End bolt row adjacent to a stiffener	The smaller of $2\pi m$ $\pi m + 2e_1$	$e_1 + \alpha m - (2m + 0,625e)$	not relevant	not relevant
Mode 1:	$l_{eff,1} = l_{eff,nc}$ but $l_{eff,1} \leq l_{eff,cp}$		$\Sigma l_{eff,1} = \Sigma l_{eff,nc}$ but $\Sigma l_{eff,1} \leq \Sigma l_{eff,cp}$	
Mode 2:	$l_{eff,1} = l_{eff,nc}$		$\Sigma l_{eff,1} = \Sigma l_{eff,nc}$	

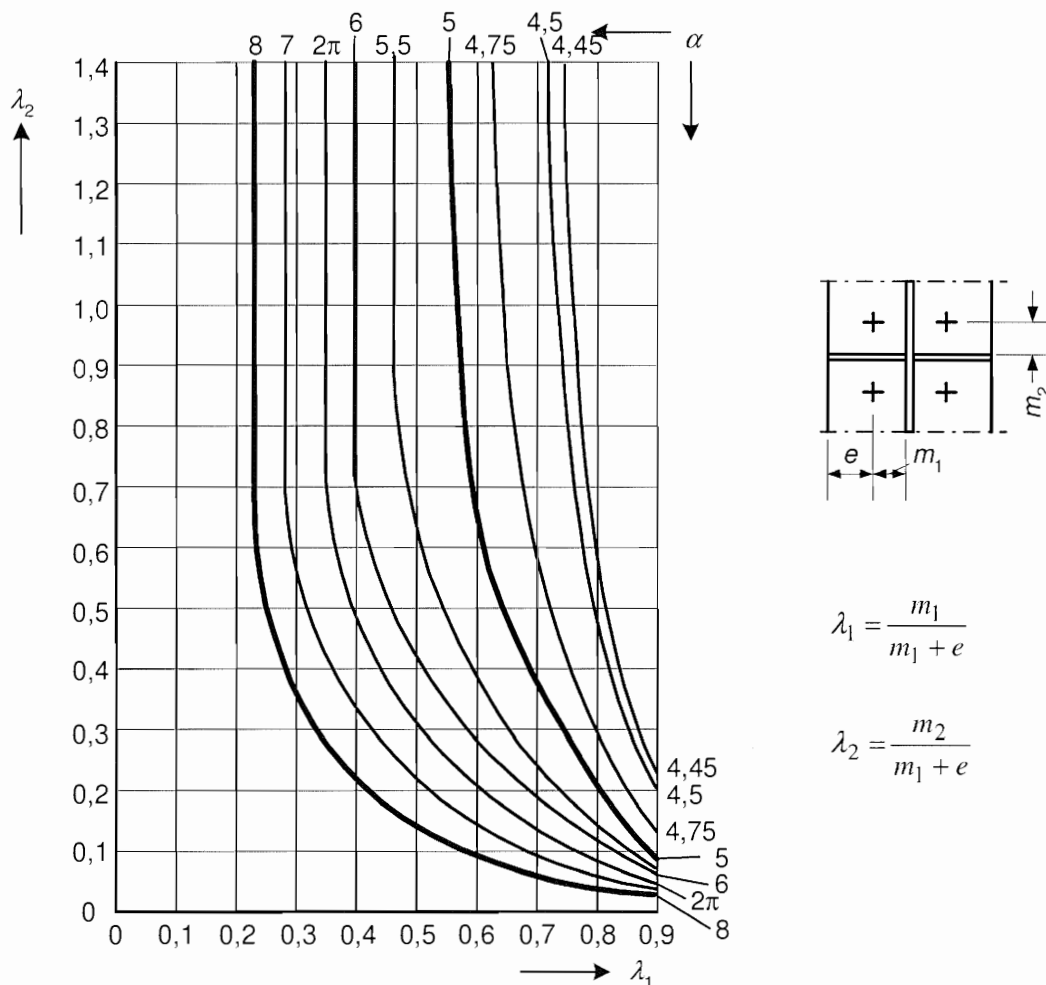

Figure B.4 - Values of factor α for the effective length for stiffened flanges

B.2 Individual bolt-row, bolt-groups and groups of bolt-rows

Although in an actual T-stub flange the forces at each bolt-row are generally equal, if an equivalent T-stub flange is used to model a basic component in a joint, allowance should be made for the forces are generally different at each bolt-row.

When modeling a basic joint component by equivalent T-stub flanges, if necessary more than one equivalent T-stub may be used, with the bolt-rows divided into separate bolt-groups corresponding to each equivalent T-stub flange (see Figure B.1).

- (1) The following conditions should be satisfied:
 - a) the force at each bolt-row should not exceed the resistance determined considering only that individual bolt-row;
 - b) the total force on each group of bolt row, comprising two or more adjacent bolt-row within the same bolt-group, should not exceed the resistance of that group of bolt-row.
- (2) Accordingly, when obtaining the tension resistance of the basic component represented by an equivalent T-stub flange, the following parameters should generally be determined:
 - a) the maximum resistance of an individual bolt-row, determined considering only that bolt-row, see Figure B.5(a);
 - b) the contribution of each bolt-row to the maximum resistance of two or more adjacent bolt-row within a bolt-group, determined considering only those bolt-rows, see Figure B.5(b).
- (3) In the case of an individual bolt-row Σl_{eff} should be taken as equal to the effective length l_{eff} given in Table B.1 and Table B.2 for that bolt-row as an individual bolt-row.
- (4) In the case of a group of bolt-rows Σl_{eff} should be taken as equal to the effective length l_{eff} given in Table B.1 and Table B.2 for each relevant bolt-row as part of a bolt group.

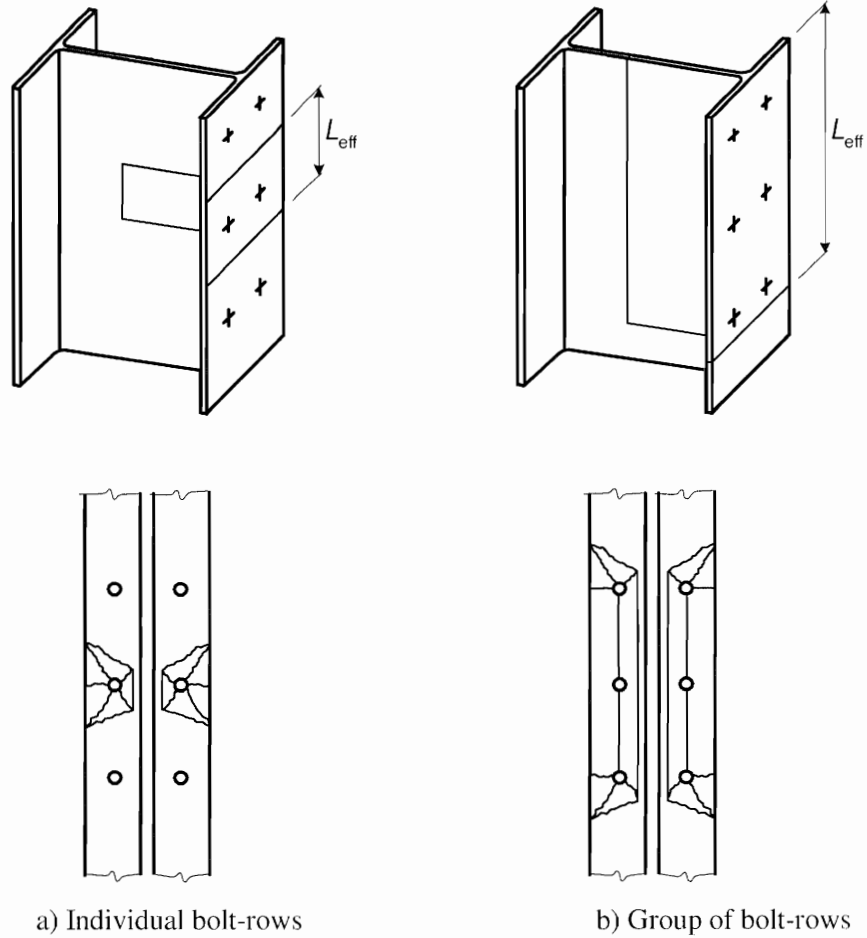

Figure B.5 - Equivalent T-stub for individual bolt-rows and groups of bolt-rows.

Annex C [informative] - Materials selection

C.1 General

(1) The choice of a suitable aluminium or aluminium alloy material for any application in the structural field is determined by a combination of factors; strength, durability, physical properties, weldability, formability and availability both in the alloy and the particular form required. The wrought and cast alloys are described below subdivided into heat treatable and non-heat treatable alloys.

(2) The properties and characteristics of these alloys may be compared in general terms in Table C.1 for wrought aluminium alloys and Table C.2 for casting alloys. Properties and characteristics may vary with temper of the alloy.

(3) If connections are to be made to other metals, specialist advice should be sought on the protective measures necessary to avoid galvanic corrosion.

C.2 Wrought products

C.2.1 Wrought heat treatable alloys

(1) Within the 6xxx series alloys, the alloys EN AW-6082, EN AW-6061, EN AW-6005A, EN AW-6106, EN AW-6063 and EN AW-6060 are suitable for structural applications. These alloys have durability rating B. Within the 7xxx series alloys, the alloy EN AW-7020 is suitable for general structural applications and has durability rating C.

C.2.1.1 Alloys EN AW-6082 and EN AW-6061

(1) EN AW-6082 is one of the most widely used heat treatable alloy and often the principal structural alloy for welded and non-welded applications. It is a high strength alloy available in most forms; solid and hollow extrusions, tube, plate, sheet and forging, and finds increasing use in components exposed to the marine environment. EN AW-6061 is also a widely used heat treatable alloy for welded and non-welded applications available in solid and hollow extrusions and tube. Both alloys are used normally in the fully heat-treated condition EN AW-6082-T6 and EN AW-6061-T6.

(2) The choice of these alloys as a structural material is based on a favourable combination of properties; high strength after heat treatment, good corrosion resistance, good weldability by both the MIG and TIG processes good formability in the T4 temper and good machining properties. Loss of strength in the heat-affected zone (HAZ) of welded joints should be considered. Strength can be recovered to a limited degree by post weld natural ageing. If used in extrusions it is generally restricted to thicker less intricate shapes than with the other 6xxx series alloys. AW-6082 is a common alloy for extrusions, plate and sheet from stock. The alloy may be riveted using alloys EN AW-6082, EN AW-5754 or EN AW-5019 in O or harder tempers, filler metals for welding are specified in prEN 1011-4.

C.2.1.2 Alloys EN AW-6005A

(1) EN AW-6005A alloy which is also recommended for structural applications, is available in extruded forms only and combines medium strength with the ability to be extruded into shapes more complex than those obtainable with EN AW-6082 or EN AW-6061. This is particularly true for thin-walled hollow shapes. Like EN AW-6082 and EN AW-6061, the alloys are readily welded by the TIG and MIG processes and have similar loss of strength in the HAZ in welded joints. Filler metals for welding these alloys are specified in prEN 1011-4.

(2) The corrosion resistance of welded and unwelded components is similar or better than EN AW-6082. The machining properties are similar to those of EN AW-6082.

Table C.1 - Comparison of general characteristics and other properties for structural alloys

Alloy EN- Designation	Form and temper standardised for					Strength	Durability rating ^{a)}	Weldability	Decorative anodising	
	Sheet, strip and plate	Extruded products			Cold drawn products					Forgings
		Bar / rod	Tube	Profile						
EN AW-3004	○	-	-	-	-		III/IV	A	I	I
EN AW-3005	○	-	-	-	-		III/IV	A	I	I
EN AW-3103	○	○	○	○	○		III/IV	A	I	II
EN AW-5005	○	○	○	○	○		III/IV	A	I	I
EN AW-5049	○	-	-	-	-		II/III	A	I	I/II
EN AW-5052	○	○	○ x)	○ x)	○		II/III	A	I	I/II
EN AW-5083	○	○	○ x)	○ x)	○	○	I/II	A	I	I/II
EN AW-5454	○	○	○ x)	○ x)	-		II/III	A	I	I/II
EN AW-5754	○	○	○ x)	○ x)	○	○	II/III	A	I	I/II
EN AW-6060	-	○	○	○	○		II/III	B	I	I
EN AW-6061	-	○	○	○	○		II/III	B	I	II/III
EN AW-6063	-	○	○	○	○		II/III	B	I	I/II
EN AW-6005A	-	○	○	○	-		II	B	I	II/III
EN AW-6106	-	-	-	○	-		II/III	B	I	I/II
EN AW-6082	○	○	○	○	○	○	I/II	B	I	II/III
EN AW-7020	○	○	○	○	○		I	C	I	II/III
EN AW-8011A	○	-	-	-	-	-	III/IV	B	II	III/IV

Key: ○ Standardised in a range of tempers; Availability of semi products from stock to be checked for each product and dimension
 - Not standardised
 x) Simple, solid sections only (seamless products over mandrel)
 I Excellent
 II Good
 III Fair
 IV Poor

NOTE These indications are for guidance only and each ranking is only applicable in the column concerned and may vary with temper

a) See Table 3.1a.

Table C.2 - Comparison of casting characteristics and other general properties

Casting alloy	Form of casting		Castability	Strength	Durability rating	Decorative anodising	Weldability
	Sand	Chill or permanent mould					
EN AC-42100		●	II	II/III	B	IV	II
EN AC-42200		●	II	II	B	IV	II
EN AC-43300	●	●	I	II	B	V	II
EN AC-43000		●	I/II	IV	B	V	II
EN AC-44200	●	●	I	IV	B	V	II
EN AC-51300	●	●	III	IV	A	I	II

Key: I Excellent
II Good
III Fair
IV Poor
V Not recommended
● Indicates the casting method recommended for load bearing parts for each alloy.

NOTE 1 These indications are for guidance only and each ranking is only applicable in the column concerned.

NOTE 2 The properties will vary with the condition of the casting.

C.2.1.3 Alloys EN AW-6060, EN AW-6063 and EN AW 6106

(1) EN AW-6060, EN AW-6063 and EN AW-6106 are recommended for structural applications and are available in extruded and cold drawn products only. They are used if strength is not of paramount importance and has to be compromised with appearance where they offer good durability and surface finish and the ability to be extruded into thin walled and intricate shapes. The alloys are particularly suited to anodising and similar finishing processes. Like other 6xxx series alloys they are readily weldable by both MIG and TIG processes and lose strength in welded joints in the HAZ. Filler metals for welding these alloys are specified in prEN 1011-4.

C.2.1.4 Alloys EN AW-7020

(1) EN AW-7020 alloys are recommended for structural applications for welded and non-welded applications. It is a high strength alloy available in solid and hollow extrusions; plate and sheet and tube. This alloy is not as easy to produce in complicated extrusions as 6xxx series alloys and is not readily available. It is used normally in the fully heat treated condition EN AW-7020 T6. It has better post weld strength than the 6xxx series due to its natural ageing property. This alloy and others in the 7xxx series of alloys are however sensitive to environmental conditions and its satisfactory performance is as dependent on correct methods of manufacture and fabrication as on control of composition. Due to the susceptibility of exfoliation corrosion, material in T4 temper should only be used in the fabrication stage provided the structure could be artificially aged after completion. If not heat-treated after welding, the need for protection of the HAZ should be checked according to D.3.2. If a material in the T6 condition is subjected to any operations which induce cold work such as bending, shearing or punching etc., the alloy may be made susceptible to stress corrosion cracking. It is essential therefore that there be direct collaboration between the designer and the manufacturer on the intended use and the likely service conditions.

C.2.2 Wrought non-heat treatable alloys

(1) Within the 5xxx series alloys, the alloys EN AW-5049, EN AW-5052, EN AW-5454 and EN AW-5754 and EN AW-5083 are recommended for structural applications all have durability rating A. Other non-heat treatable alloys considered for less stressed structural applications are EN AW-3004, EN AW-3005, EN AW-3103 and EN AW-5005 again with durability rating A.

C.2.2.1 EN AW-5049, EN AW-5052, EN AW-5454 and EN AW-5754

(1) EN AW-5049, EN AW-5052, EN AW-5454 and EN AW-5754 are suitable for welded or mechanically joined structural parts subjected to moderate stress. The alloys are ductile in the annealed condition, but lose ductility rapidly with cold forming. They are readily welded by MIG and TIG processes using filler metals specified in prEN 1011-4 and offer very good resistance to corrosive attack, especially in a marine atmosphere. Available principally as rolled products their reduced magnesium content also allows only simple extruded solid shapes.

(2) The alloys can be easily machined in the harder tempers. EN AW-5754 is the strongest 5xxx series alloy offering practical immunity to intergranular corrosion and stress corrosion.

C.2.2.2 EN AW-5083

(1) EN AW-5083 is the strongest non-heat treatable structural alloy in general commercial use, possessing good properties in welded components and good corrosion resistance. It is ductile in the soft condition with good forming properties but loses ductility with cold forming, and can become hard with low ductility.

(2) EN AW-5083 may in all tempers (Hx), especially in H32 and H34 tempers, be susceptible to intergranular corrosion, which under certain circumstances, may develop into stress corrosion cracking under sustained loading. Special tempers such as H116 have been developed to minimise this effect. Nevertheless the use of this alloy is not recommended where the material is to be subjected to further heavy cold working and/or where the service temperature is expected to be above 65° C. In such cases the alloy EN AW-5754 should be selected instead.

(3) If the service conditions for the alloy/temper to be used are such that there is a potential for stress corrosion cracking, the material should be checked in a stress corrosion test prior to its delivery. The conditions for the test should be agreed between the parties concerned, taking the relevant service conditions and the material properties of the actual alloy/temper into account.

(4) EN AW-5083 is fitted to be welded with the MIG and the TIG processes applying filler metals specified in prEN 1011-4. If strain hardened material is welded, the properties in the HAZ will revert to the annealed temper. The alloy is available as plate, sheet, simple solid shape extrusions, seamless tube, drawn tube and forging. Due to the high magnesium content it is difficult to extrude. Consequently it is limited to delivery in relatively thick-walled simple solid profiles and seamless hollow profiles with one hollow space (tubes).

(5) EN AW-5083 has good machining properties in all tempers.

C.2.2.3 EN AW-3004, EN AW-3005, EN AW-3103 and EN AW-5005

(1) EN AW-3004, EN AW-3005, EN AW-3103 and EN AW-5005 are available and used preferably in sheet and plate forms. These alloys are slightly stronger and harder than „commercially pure“ aluminium with high ductility, weldability and good corrosion resistance.

C.2.2.4 EN AW-8011A

(1) EN AW-8011A belongs to the AlFeSi group and has a long tradition used preferably as material for packaging. Due to its advantages in fabrication EN AW-8011A finds more and more application in building industry especially for facades.

C.3 Cast products

C.3.1 General

(1) The casting materials of Table 3.3 may be used for load carrying parts under the provision that special design rules and quality requirements given in C.3.4 are observed.

(2) Six foundry alloys are recommended for structural applications, four heat treatable alloys EN AC-42100, EN AC-42200, EN AC-43000 and EN AC-43300 plus two non-heat treatable alloys, EN AC-44200 and EN AC-51300. These alloys are described below. The alloys will normally comply with the requirements for elongation given in C.3.4.3. Due to the low Cu content they also have good corrosion resistance.

C.3.2 Heat treatable casting alloys EN AC-42100, EN AC-42200, EN AC-43000 and EN AC-43300

(1) EN AC-42100, EN AC-42200, EN AC-43000 and EN AC-43300 are all alloys in the Al-Si-Mg system and are responsive to heat treatment. All are suitable for sand and chill or permanent mould castings but are not normally used for pressure die castings except by using advanced casting methods. The highest strength is achieved with EN AC-42200-T6 but with a lower ductility than EN AC-42100.

(2) EN AC-43300 exhibits the best foundry castability with fair resistance to corrosion, good machinability and weldability. Foundry castability of alloys EN AC-42100 and EN AC-42200 is good, with good resistance to corrosion and machinability.

C.3.3 Non-heat treatable casting alloys EN AC-44200 and EN AC-51300

(1) EN AC-44200 and EN AC-51300 alloys are suitable for sand and chill or permanent mould castings but not recommended for pressure die castings. Alloy EN AC-44200 possesses excellent foundry castability, but EN AC-51300 has fair castability and is only suitable for more simple shapes. EN AC-51300 has the highest strength, has excellent resistance to corrosion and is machinable. The EN AC-51300 alloy may be decoratively anodised.

C.3.4 Special design rules for castings

C.3.4.1 General design provisions

(1) The special design rules are applicable to cast parts which have geometry and applied actions where buckling cannot occur. The cast component should not be formed by bending or welded or machined with sharp internal corners.

(2) The design of load carrying parts of casts in temper and casting method as listed in Table 3.3 should be done on the basis of linear elastic analysis by comparing the equivalent design stress

$$\sigma_{\text{eq,Ed}} = \sqrt{\sigma_{x,\text{Ed}}^2 + \sigma_{y,\text{Ed}}^2 - \sigma_{x,\text{Ed}} \sigma_{y,\text{Ed}} + 3\tau_{xy,\text{Ed}}^2} \quad (\text{C.1})$$

with the design strength σ_{Rd} , where σ_{Rd} is the lesser of $f_{\text{oc}}/\gamma_{\text{M0,c}}$ and $f_{\text{uc}}/\gamma_{\text{Mu,c}}$.

NOTE Partial factors $\gamma_{\text{M0,c}}$ and $\gamma_{\text{Mu,c}}$ may be defined in the National Annex. The following numerical values are recommended for buildings:

$$\gamma_{\text{M0,c}} = 1,1 \text{ and } \gamma_{\text{Mu,c}} = 2,0$$

(3) The design bearing resistance of bolts and rivets should be taken as the lesser value from the following two expressions, based on equation (8.11) of Table 8.5:

$$F_{\text{b,Rd}} = k_1 \alpha_b f_{\text{uc}} d t / \gamma_{\text{M2,cu}} \quad (\text{C.2})$$

$$F_{\text{b,Rd}} = k_1 \alpha_b f_{\text{oc}} d t / \gamma_{\text{M2,co}} \quad (\text{C.3})$$

NOTE Partial factors $\gamma_{\text{M2,cu}}$ and $\gamma_{\text{M2,co}}$ may be defined in the National Annex. The following numerical values are recommended for buildings:

$$\gamma_{\text{M2,cu}} = \gamma_{\text{Mu,c}} = 2,0 \quad \text{and} \quad \gamma_{\text{M2,co}} = \gamma_{\text{M0,c}} = 1,1$$

(4) The design bearing resistance for the plate material of pin connections $F_{b,Rd}$ should be taken as the lesser value from the following two expressions, based on Table 8.7:

$$F_{b,Rd} = 1,5 f_{uc} d t / \gamma_{Mp,cu} \quad (C.4)$$

$$F_{b,Rd} = 1,5 f_{oc} d t / \gamma_{Mp,co} \quad (C.5)$$

NOTE Partial factors $\gamma_{Mp,co}$ and $\gamma_{Mp,cu}$ may be defined in the National Annex. The following numerical values are recommended for buildings:

$$\gamma_{Mp,co} = \gamma_{Mp} = 1,25 \quad \text{and} \quad \gamma_{Mp,cu} = \gamma_{Mu,c} = 2,0$$

(5) The specification for the cast part should include the following information:

- a) areas with tension stresses and utilization of the design resistance of more than 70 % (areas H);
- b) areas with tension stresses and utilization of the design resistance between 70 and 30 % (areas M);
- c) areas with compressive stresses and utilization of the design resistance between 100 and 30 % (areas M);
- d) areas with utilization of the design resistance of less than 30 % (areas N);
- e) the location and direction where the sampling for the material test should be made. The location should be identical or close to the location with the highest stresses of the component. If there are various areas with high stresses, sampling should be executed at more than one location;
- f) all tests to be performed and any test conditions deviating from EN 1706, qualification procedures and qualification requirements;
- g) the required minimum values for strength and elongation.

C.3.4.2 Quality requirements, testing and quality documentation

(1) To check the mechanical properties of each area specified as having high strain two test specimens should be taken from the batch. In some cases also areas with difficult casting conditions should be specified as areas to be tested. The test results for ultimate strength and yield strength should not be less than the values in Table 3.3. Deviating from Table 3.3, the A_5 -elongation ($A_{5,65,\sqrt{A_0}}$) should not be less than 2 %. If sand casting is used it is allowed to thicken the cast part in the areas with the highest stresses or where the test specimens should be taken so that these can be taken without the casting being destroyed.

(2) The following requirements apply to limitation of internal defects:

- a) Cracks in the cast parts are not allowed.
- b) For porosity the limiting values are:
 - H-areas: 4 %
 - M-areas: 6 %
 - N-areas: 8 %

The diameter of pores should be less than 2 mm.

- c) Each casting should be subject to penetrant testing for exterior cracks and to radiation test for interior defects using image intensifier unless otherwise specified. The amount of inspection may be reduced if the cast parts are subject to only compressive stresses. The following standards specify the test procedures: EN 1371-1 in combination with EN 571 for the penetrant testing and prEN 13068 (radiology) or $\overline{A_1}$ EN 12681 $\overline{A_1}$ (radiography) in combination with EN 444 for carrying out the radiation test.

(3) Test procedures and delivery details regarding the test and the quality requirements of EN 1559-1 and EN 1559-4 should be agreed and given in written specifications for the tests. Repair welding is only allowed to repair minor casting defects. The manufacturer should inform about any need for and the result of such repair.

(4) The supplier of cast products should confirm all required material properties and the tests executed to fulfil the specified requirements by an inspection certificate 3.1.B in accordance with EN 10204.

C.4 Connecting devices

C.4.1 Aluminium bolts

(1) In lack of EN standards for aluminium bolts, the aluminium bolts given in Table 3.4 should only be used if the bolt manufacturer certifies that the bolts are produced and tested according to EN 28839 with regard to mechanical properties and that geometrical tolerances correspond to those for steel bolts according to EN 24014 or EN 24017. If the use of bolts with threads manufactured by cutting is not allowed it should be stated in the specification. All requirements for the bolts should be given in the specification. The bolt manufacturer should confirm that the material properties and the tests executed to check this by issuing an inspection certificate 3.1.B according to EN 10204.

C.4.2 Aluminium rivets

(1) In lack of EN standards for aluminium rivets, the solid aluminium rivets listed in Table 3.4 should only be used if the manufacturer certifies that they are produced of drawn round bar material according to EN 754 or drawn round wire material according to EN 1301 and expressly that the strength values of the rivet also fulfil the values of these standards.

(2) The following requirements concerning the geometry should be observed: Depth of head $\geq 0,6d$; diameter of head $\geq 1,6d$, radius $\geq 0,75d$, no countersunk (d = nominal diameter of the solid shaft; see also Figure C.1). The requirements defined here should be inserted in the design specification and in all drawings with the remark that all procurement has to be done accordingly.

(3) The manufacturer of the rivets has to confirm all required material properties and tests to be executed fulfilling the specified requirement by an inspection certificate 3.1.B according to EN 10204.

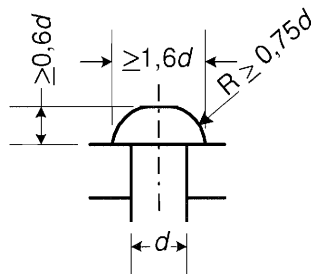

Figure C.1 - Minimum head dimensions of solid shaft rivets (no countersunk)

Annex D [informative] – Corrosion and surface protection

D.1 Corrosion of aluminium under various exposure conditions

(1) This annex gives information on corrosion tendency of aluminium alloys and recommendations for selection and protection of aluminium alloys dependant on the various exposure conditions.

(2) The corrosion resistance of aluminium alloys is attributable to the protective oxide film which forms on the surface of the metal immediately on exposure to air. This film is normally invisible, relatively inert and as it forms naturally on exposure to air or oxygen, and in many complex environments containing oxygen; the protective film is thus self sealing.

(3) In mild environments an aluminium surface will retain its original appearance for years, and no protection is needed for most alloys. In moderate industrial conditions there will be a darkening and roughening of the surface. As the atmosphere becomes more aggressive such as in certain strongly acidic or strongly alkaline environments, the surface discoloration and roughening will be worse with visible white powdery surface oxides and the oxide film may itself be soluble. The metal ceases to be fully protected and added protection is necessary. These conditions may also occur in crevices due to high local acid or alkaline conditions, but agents having this extreme effect are relatively few in number.

(4) In coastal and marine environments the surface will roughen and acquire a grey, stone-like, appearance, and protection of some alloys is necessary. Where aluminium is immersed in water special precautions may be necessary.

(5) Where surface attack does occur corrosion time curves for aluminium and aluminium alloys usually follow an exponential form, with an initial loss of reflectivity after slight weathering. After this there is very little further change over very extensive periods. On atmospheric exposure, the initial stage may be a few months or two to three years, followed by little, if any, further change over periods of twenty, thirty or even eighty years. Such behaviour is consistent for all external freely exposed conditions and for all internal or shielded conditions, except where extremes of acidity or alkalinity can develop. Tropical environments are in general no more harmful to aluminium than temperate environments, although certain 5xxx-alloys are affected by long exposure to high ambient temperatures, particularly if in marine environment.

(6) Generally the structure should be designed according to known practice for avoiding corrosion. The possibility of galvanic corrosion and crevice corrosion should be evaluated and avoided due to proper design. All parts should be well drained.

(7) If a decorative appearance of aluminium is required to be kept for a long time the suitable surface treatments are organic coatings (liquid coating, powder coating) and anodic oxidation. The execution specification should define the detail requirements. Deviations of colour appearance should be taken in account and should be agreed and defined e.g. by limit samples. Differences in appearance may occur by different lots of semi-products, by different lots of coating material and by different coaters. For the selection of suitable surface treatments the different behaviours of the systems concerning repairability, weathering resistance and cleanability should be taken in account. Specifications for anodic oxidation are given in EN 12373-1

D.2 Durability ratings of aluminium alloys

(1) The aluminium alloys listed in Tables 3.1a and 3.1b are categorised into three durability ratings; A, B and C in descending order of durability. These ratings are used to determine the need and degree of protection required. In structures employing more than one alloy, including filler metals in welds, the classification should be in accordance with the lowest of their durability ratings.

(2) For advice on the durability rating of aluminium alloys see Annex C.

(3) Table D.1 gives recommendation for corrosion protection for the three classes of durability ratings.

D.3 Corrosion protection

D.3.1 General

(1) The execution specification should describe type and amount of protective treatment. The type of corrosion protection should be adapted to the corrosion mechanism as surface corrosion, galvanic induced corrosion, crevice corrosion and corrosion due to contamination by other building materials. Crevice corrosion can occur in any type of crevice, also between metal and plastic. Special building conditions may provoke corrosion e.g. if a copper roof is installed over aluminium elements.

(2) For the selection of a suitable corrosion protection the following item should be taken in account: Damages on organic coatings are to a certain degree repairable. Anodised parts have to be handled very carefully in transport and erection. Therefore protecting foils should be used.

(3) Anodic oxidation and organic coating under many circumstances are equivalent, under special conditions the one or other surface treatment is doubtless to prefer, depending on corrosive agents and the environment that influence the corrosion effects. In case of corrosion protection in combination with decorative aspects, see D.3.2(7). Specifications for anodic oxidation should be based on the EN 12373-1.

(4) Passivation is a short-term protection or for mild conditions.

D.3.2 Overall corrosion protection of structural aluminium

(1) The need to provide overall corrosion protection to structures constructed from the alloys listed in Tables 3.1a and 3.1b if exposed to various environments is given in Table D.1. The methods of providing corrosion protection are given in [\[A1\]](#) EN 1090-3 [\[A1\]](#). For the protection of sheet used in roofing and siding see [\[A1\]](#) EN 508-2 [\[A1\]](#).

(2) In selecting the appropriate column of Table D.1 for a given exposure, a presence of localities within a region that have 'microclimates' significantly different from the environmental characteristics of the region as a whole should be evaluated. A region designated 'rural' may have local environments more closely resembling an industrial atmosphere at sites close to and down wind of factories. Similarly, a site near the sea but close to shore installations may, with the appropriate prevailing winds, have the characteristics of an industrial, rather than marine, atmosphere. The environment is not necessarily the same for a structure inside a building as for one outside.

(3) The occurrence of corrosion depends not only on the susceptibility of the material and the global conditions, but in practice more on the period of time during which moisture may be present in conjunction with entrapped dirt and corrosive agents. Areas of members, or structural details, where dirt is trapped or retained are more critical than areas where rain, and wind driven rain, cleans the surface and drying occurs quickly. This means that sheltered ledges should be avoided and that pockets in which water can remain should be eliminated or provided with effective draining devices.

(4) In assessing the need and level of protection required the design life history of the structure should be considered. For short life structures less stringent measures or no protection may be acceptable. Where planned inspection and maintenance will reveal the onset of corrosion at an early stage, so allowing remedial action to be taken, the initial level of protection provided may be permitted to be relaxed. Whereas, where inspection is impractical and evidence of corrosion attack will not be revealed, the initial level of protection must be higher. Therefore the need for protection in those cases marked (P) on Table D.1 should be established in conjunction with the engineer, manufacturer and if necessary a corrosion specialist.

(5) Because of these factors, localised conditions of increased severity may result. It is advisable to study the precise conditions prevailing at the actual site before deciding on the appropriate environment column of Table D.1.

Table D.1 - Recommendations for corrosion protection for various exposure conditions and durability ratings

Alloy durability rating	Material thickness mm	Protection according to the exposure							
		Atmospheric						Immersed	
		Rural	Industrial/urban		Marine			Fresh-water	Sea water
			Mode-rate	Severe	Non-industrial	Mode-rate	Se-vere		
A	All	0	0	(Pr)	0	0	(Pr)	0	(Pr)
B	< 3	0	0	(Pr)	(Pr)	(Pr)	(Pr)	Pr	Pr
	≥ 3	0	0	0	0	0	(Pr)	(Pr)	Pr
C	All	0	0 ²⁾	(Pr) ²⁾	0 ²⁾	0 ²⁾	(Pr) ²⁾	(Pr) ¹⁾	NR

0 Normally no protection necessary
Pr Protection normally required except in special cases, see D.3.2
(Pr) The need for protection depends on if there are special conditions for the structure, see D.3.2. In case there is a need it should be stated in the specification for the structure
NR Immersion in sea water is not recommended
1) For 7020, protection only required in Heat Affected Zone (HAZ) if heat treatment not applied after welding
2) If heat treatment of 7020 after welding is not applied, the need to protect the HAZ should be checked with respect to conditions, see D.3.2.

NOTE For the protection of sheet used in roofing and siding see [EN 508-2](#).

(6) Where hollow sections are employed consideration should be given to the need to protect the internal void to prevent corrosion arising from the ingress of corrosive agents. Because of the difficulty of painting such sections, chemical conversion coatings may be of benefit. Where the internal void is sealed effectively or if no water can congregate inside the section, internal protection is not necessary.

D.3.3 Aluminium in contact with aluminium and other metals

(1) Consideration should be given to contacting surfaces in crevices and contact with certain metals or washings from certain metals which may cause electrochemical attack of aluminium. Such conditions can occur within a structure at joints. Contact surfaces and joints of aluminium to aluminium or to other metals and contact surfaces in bolted, riveted, welded and high strength friction grip bolted joints should be given additional protection to that required by Table D.1 as defined in Table D.2. Details of the corrosion protection procedure required are given in [EN 1090-3](#). For the protection of metal to metal contacts including joints for sheet used in roofing and siding see [EN 508-2](#).

(2) Where pre-painted or protected components are assembled, an additional sealing of the contact surfaces should be defined in the execution specification including type and procedure of the sealing. Requirements should consider expected life of the structure, the exposure and the protection quality of the pre-protected components.

D.3.4 Aluminium surfaces in contact with non-metallic materials

D.3.4.1 Contact with concrete, masonry or plaster

(1) Aluminium in contact with dense compact concrete, masonry or plaster in a dry unpolluted or mild environment should be coated in the contacting surface with a coat of bituminous paint, or a coating providing the same protection. In an industrial or marine environment the contacting surface of the aluminium should be coated with at least two coats of heavy-duty bituminous paint; the surface of the

contacting material should preferably be similarly painted. Submerged contact between aluminium and such materials is not recommended, but if unavoidable, separation of the materials is recommended by the use of suitable mastic or a heavy duty damp course layer.

(2) Lightweight concrete and similar products require additional consideration if water or rising damp can extract a steady supply of aggressive alkali from the cement. The alkali water can then attack aluminium surfaces other than the direct contact surfaces.

D.3.4.2 Embedment in concrete

(1) The aluminium surfaces should be protected with at least two coats of bituminous paint or hot bitumen, and the coats should extend at least 75 mm above the concrete surface.

(2) Where the concrete contains chlorides (e.g. as additives or due to the use of sea-dredged aggregate), at least two coats of plasticised coal-tar pitch should be applied in accordance with the manufacturer's instructions and the finished assembly should be over-painted locally with the same material, after the concrete has fully set, to seal the surface. Care should be taken where metallic contact occurs between the embedded aluminium parts and any steel reinforcement.

D.3.4.3 Contact with timber

(1) In an industrial, damp or marine environment the timber should be primed and painted.

(2) Some wood preservatives may be harmful to aluminium. The following preservatives are generally accepted as safe for use with aluminium without special precautions:

- Creosote; zinc naphthenates and zinc-carboxylates; formulations containing nonionic organic biocides, e.g. propiconazole, carbendazim also solvent born preservatives.

(3) The following preservatives should only be used in dry situations and where the aluminium surface in contact with the treated timber has a substantial application of sealant:

- Copper naphthenate; fixated CC-, CCA- and CCB-preservatives, formulations containing boron compounds or quaternary ammonium compounds.

(4) The following preservatives should not be used in association with aluminium:

- non fixing inorganic formulations containing water-soluble copper- or zinc-compounds, also formulations containing acid and alkaline ingredients (pH < 5 and pH > 8).

(5) Oak, chestnut and western red cedar, unless well seasoned, are likely to be harmful to aluminium, particularly where these are through fastenings.

D.3.4.4 Contact with soils

(1) The surface of the metal should be protected with at least two coats of bituminous paint, hot bitumen, or plasticised coal tar pitch. Additional wrapping-tapes may be used to prevent mechanical damage to the coating.

D.3.4.5 Immersion in water

(1) Where aluminium parts are immersed in fresh or sea water including contaminated water, the aluminium should preferably be of durability rating A, with fastenings of aluminium or corrosion-resisting steel or fastened by welding. Tables D.1 and D.2 give the protection requirements for fresh water and sea water immersion.

(2) Data on the oxygen content, pH number, chemical or metallic, particularly copper content and the amount of movement of the water should be obtained as these factors may affect the degree of protection required.

D.3.4.6 Contact with chemicals used in the building industry

(1) Fungicides and mould repellents may contain metal compounds based on copper, mercury, tin and lead which, under wet or damp conditions could cause corrosion of the aluminium. The harmful effects may be countered by protecting the contacting surfaces which may be subject to washing or seepage from the chemicals.

(2) Some cleaning materials can affect ($\text{pH} < 5$ and $\text{pH} > 8$) the surface of the aluminium. Where such chemicals are used to clean aluminium or other materials in the structure, care should be taken to ensure that the effects will not be detrimental to the aluminium. Often quick and adequate water rinsing will suffice, while in other situations temporary measures may be necessary to protect the aluminium from contact with the cleaners.

D.3.4.7 Contact with insulating materials used in the building industry

Products such as glass fibre, polyurethane and various insulation products may contain corrosive agents which can be extracted under moist conditions to the detriment of the aluminium. Insulating materials should be tested for compatibility with aluminium under damp and saline conditions. Where there is doubt a sealant should be applied to the associated aluminium surfaces.

Table D.2 - Additional protection at metal-to-metal contacts to take precautions against crevice and galvanic effects

Metal to be joined to aluminium	Bolt or rivet material	Protection according to exposure																	
		Atmospheric								Marine						Immersed			
		Rural				Industrial urban				Non industrial		Industrial				Fresh water		Sea water	
		Dry, un-polluted		Mild		Moderate		Severe				Moderate		Severe					
(M)	(B/R)	M	B/R	M	B/R	M	B/R	M	B/R	M	B/R	M	B/R	M	B/R	M	B/R	M	B/R
Aluminium	Aluminium		0		0		0		1		(1)		(1)		1		1		1
	Stainless steel	0	0	0	0	0/X	0	X _a	1	0/X	(1)	0/X _a	1	X _a	1	X	1	X	1 2
	Zinc-coated steel		0		(2)		(1) (2)		1 (2)		(1) (2)		(1) (2)		1 (2)		1 2		1 2
Zinc-coated steel	Aluminium		0		0		0		1		(1)		(1)		1		1		1 2
	Stainless steel	0	0	0	0	0/X _a	0	X _a	1	0/X _a	0	0/X _a	(1)	X _a	1	X _z	1 (2)	Y (Z)	1 2
Painted steel	Zinc-coated steel		0		(2)		(2)		1 (2)		(1) (2)		1 (2)		1 (2)		1 2		1 2
Stainless steel	Aluminium		0		0		0		1		(1)		(1)		1		1 2		1 2
	Stainless steel	0	0	0	0	0/X _a	0	X _a	1	0/X _a	0	0/X _a	(1)	X _a	1	Y (X)	1	Y (Z)	1 2
	Zinc-coated steel		0		(2)		(2)		1 (2)		(1) (2)		(1) (2)		1 (2)		1 2		1 2

NOTE 1 The overall protection of aluminium parts should to be decided acc. to Table D.1.

NOTE 2 Items in () should have a evaluation taking D.3.2 into account.

NOTE 3 For the protection of sheet used in roofing or siding see ^{A1}EN 508-2 ^{A1}.

NOTE 4 For stainless steels see also EN 1993-1-4.

^{A1}**Legend:**

M = metal, B = bolt, R = rivet,

Treatments applied to the contact areas of structural members ^{A1}

Procedure 0

A treatment is usually unnecessary for causes of corrosion

Procedure 0/X

Treatment depends on structural conditions. Small contact areas and areas which dry quickly may be assembled without sealing (see procedure X)

Procedure X

Both contact surfaces should be assembled so that no crevices exist where water can penetrate. Both contact surfaces, including bolt and rivet holes should, before assembly, be cleaned, pre-treated and receive one priming coat, see $\overline{A_1}$ EN 1090-3 $\overline{A_1}$, or sealing compound, extending beyond the contact area. The surfaces should be brought together while priming coat is still wet. Where assembling pre-painted or protected components sealing of the contact surfaces might be unnecessary, dependant on the composition of the paint or protection system employed, the expected life and the environment.

Procedure Y

Full electrical insulation between the two metals and all fixings should be ensured by insertion of non-absorbent, non-conducting tapes, gaskets and washers to prevent metallic contact between the materials. The use of additional coating or sealants may be necessary.

Procedure Z

Where procedure Y is required and the load transfer through the point precludes the use of insulating materials, the joint should be assembled without the use of insulating materials, with the whole joint assembly completely sealed externally to prevent moisture ingress to elements of the joint. Procedures should be established by agreement between the parties involved.

Treatment applied to bolts and rivets

Procedure 0

No additional treatment is usually necessary.

Procedure 1

Inert washers or jointing compound should be applied between the bolt heads, nuts, washers and connected materials to seal the joint and to prevent moisture entering the interface between components and fixings. Care should be employed to ensure that load transfer through the joint is not adversely affected by the washers or jointing compounds.

Procedure 2

(1) Where the joint is not painted or coated for other reasons, the heads of bolts, nuts and rivets and the surrounding areas as noted below, should be protected with at least one priming coat (see $\overline{A_1}$ EN 1090-3 $\overline{A_1}$); care being taken to seal all crevices. (2) Where zinc-coated bolts are used, the protection on the aluminium side of the joint is not necessary. (3) Where aluminium bolts or rivets are used, the protection on the aluminium side of the joint is not necessary (4) Where stainless steel bolts are used in combination with aluminium and zinc-coated steel parts, the surrounding zinc-coated area of the joint should be similarly protected

Further treatments

Procedure a

If not painted for other reasons it may be necessary to protect the adjacent metallic parts of the contact area by a suitable paint coating in cases where dirt may be entrapped or where moisture retained.

Procedure z

Additional protection of zinc-coated structural parts as a whole may be necessary

Annex E [informative] - Analytical models for stress strain relationship

E.1 Scope

- (1) This Annex provides the models for the idealization of the stress-strain relationship of aluminium alloys. These models are conceived in order to account for the actual elastic-hardening behaviour of such materials.
- (2) The proposed models have different levels of complexity according to the accuracy required for calculation.

NOTE The notations in this Annex E are specific to the different models and do not necessarily comply with those in 1.6.

E.2 Analytical models

(1) The analytical characterization of the stress (σ) - strain (ε) relationship of an aluminium alloy can be done by means of one of the following models:

- Piecewise models
- Continuous models

(2) The numerical parameters, which define each model, should be calibrated on the basis of the actual mechanical properties of the material. These should be obtained through appropriate tensile test or, as an alternative, on the bases of the nominal values given, for each alloy, in Section 3.

E.2.1 Piecewise linear models

(1) These models are based on the assumption that material σ - ε law is described by means of a multi linear curve, each branch of it representing the elastic, inelastic and plastic, with or without hardening, region respectively.

(2) According to this assumption, the characterization of the stress-strain relationship may generally be performed using either:

- bi-linear model with and without hardening (Figure E.1)
- three-linear model with and without hardening (Figure E.2)

E.2.1.1 Bi-linear model

(1) If a bi-linear model with hardening is used (Figure E.1a), the following relationships may be assumed:

$$\sigma = E\varepsilon \quad \text{for } \overline{A_1} 0 \leq \varepsilon \leq \varepsilon_p \overline{A_1} \quad (\text{E.1})$$

$$\sigma = f_p + E_1 (\varepsilon - \varepsilon_p) \quad \text{for } \varepsilon_p < \varepsilon \leq \varepsilon_{\max} \quad (\text{E.2})$$

where:

- f_p = conventional elastic limit of proportionality
- ε_p = strain corresponding to the stress f_p
- ε_{\max} = strain corresponding to the stress f_{\max}
- E = elastic modulus
- E_1 = hardening modulus

(2) In case the "Elastic-Perfectly plastic" model is assumed (Figure E.1b), the material remains perfectly elastic until the elastic limit stress f_p . Plastic deformations without hardening ($E_1 = 0$) should be considered up to ε_{\max} .

(3) In the absence of more accurate evaluation of the above parameters the following values may be assumed for both models of Figures E.1a) and b):

- f_p = nominal value of f_o (see Section 3)
- $\overline{A_1} f_{\max}$ = nominal value of f_u (see Figure E.1a and Section 3) or f_p (see Figure E.1b) $\overline{A_1}$
- ε_{\max} = $0,5 \varepsilon_u$
- $\overline{A_1} \varepsilon_u$ = nominal value of ultimate strain (see E.3) $\overline{A_1}$
- ε_p = f_o/E
- E_1 = $(f_u - f_o)/(0,5 \varepsilon_u - \varepsilon_p)$

E.2.1.2 Three-linear model

(1) If three-linear model with hardening is used (Figure E.2a), the following relationships may be assumed:

$$\sigma = E\varepsilon \quad \text{for } \boxed{A1} \ 0 \leq \varepsilon \leq \varepsilon_p \quad \boxed{A1} \quad (E.3)$$

$$\sigma = f_p + E_1 (\varepsilon - \varepsilon_p) \quad \text{for } \varepsilon_p < \varepsilon \leq \varepsilon_e \quad (E.4)$$

$$\sigma = f_e + E_2 (\varepsilon - \varepsilon_e) \quad \text{for } \varepsilon_e < \varepsilon \leq \varepsilon_{\max} \quad (E.5)$$

where:

$\boxed{A1}$ f_p = conventional elastic limit of proportionality (see E.2.1.2(3)) $\boxed{A1}$

$\boxed{A1}$ f_e = conventional limit of elasticity (see E.2.1.2(3)) $\boxed{A1}$

ε_p = strain corresponding to the stress f_p

ε_e = strain corresponding to the stress f_e

ε_{\max} = strain corresponding to the stress f_{\max}

E = elastic modulus

E_1 = first hardening modulus

E_2 = second hardening modulus

(2) In case the "Perfectly plastic" model is assumed (Figure E.2b), plastic deformations without hardening ($E_2 = 0$) should be considered for strain ranges from ε_e to ε_{\max} .

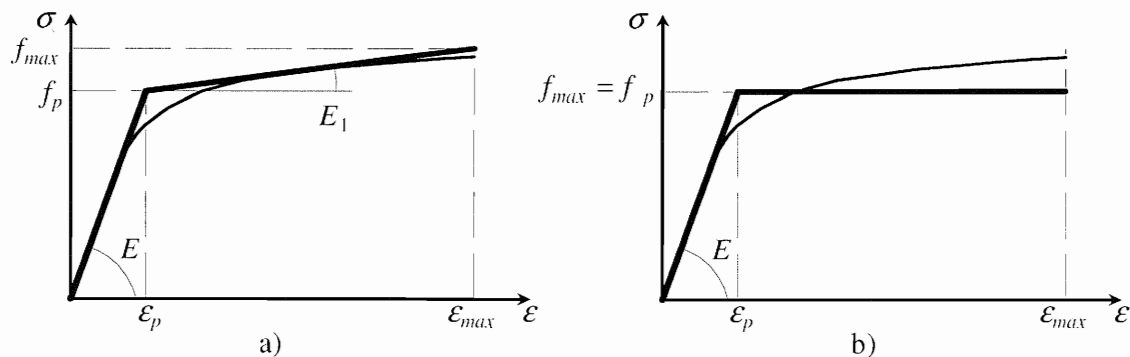

Figure E.1 - Bi-linear models

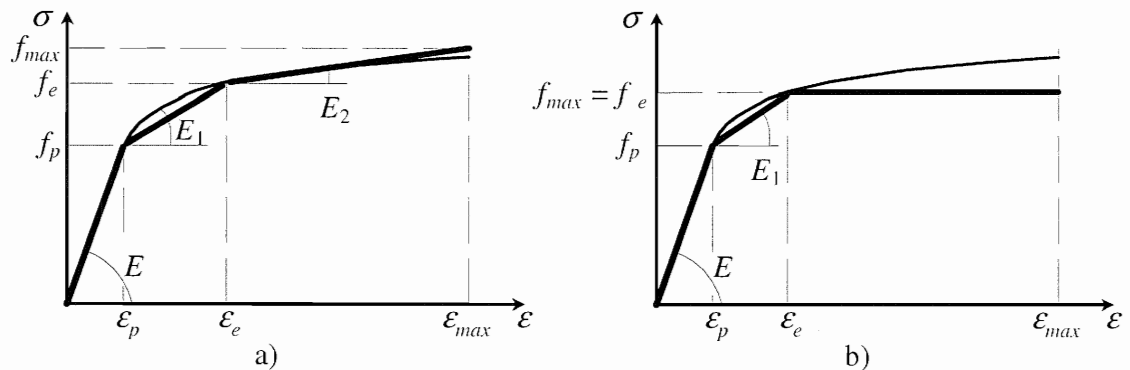

Figure E.2 - Three-linear models

$\boxed{A1}$ (3) In the absence of more accurate evaluation of the above parameters the following values may be assumed for both models of Figures E.2a) and E.2b):

$$f_p = f_{0,01}$$

f_e = nominal value of f_o (see Section 3)

f_{\max} = nominal value of f_u (see Figure E.2a and Section 3) or f_e (See Figure E.2b)

ε_u = nominal value of ultimate strain (see E.3)

$$\varepsilon_{\max} = 0,5\varepsilon_u$$

$$\varepsilon_p = f_{0,01} / E$$

$$E_1 = (f_e - f_p) / (\varepsilon_e - \varepsilon_p)$$

$$E_2 = (f_{\max} - f_e) / (\varepsilon_{\max} - \varepsilon_e) \text{ in Figure E.2a) } \boxed{A1}$$

E.2.2 Continuous models

(1) These models are based on the assumption that the material σ - ε law is described by means of a continuous relationship representing the elastic, inelastic and plastic, with or without hardening, region respectively.

(2) According to this assumption, the characterization of the stress-strain relationship may generally be performed using either:

- Continuous models in the form $\sigma = \sigma(\varepsilon)$
- Continuous models in the form $\varepsilon = \varepsilon(\sigma)$

E.2.2.1 Continuous models in the form $\sigma = \sigma(\varepsilon)$

(1) If a $\sigma = \sigma(\varepsilon)$ law is assumed, it is convenient to identify three separate regions which can be defined in the following way (see Figure E.3a):

- Region 1 elastic behavior
- Region 2 inelastic behavior
- Region 3 strain-hardening behavior

(2) In each region the behavior of the material is represented by means of different stress versus strain relationships, which have to ensure continuity at their limit points. According to this assumption, the characterization of the stress-strain relationship may be expressed as follows (Figures E.3b):

Region 1 for $\varepsilon_0 \leq \varepsilon \leq \varepsilon_p$ with $\varepsilon_p = 0,5\bar{\varepsilon}_e$ and $\bar{\varepsilon}_e = f_e / E$

$$\sigma = E \varepsilon \tag{E.6}$$

Region 2 for $\varepsilon_p < \varepsilon \leq 1,5\bar{\varepsilon}_e$

$$\sigma = f_e \left[-0,2 + 1,85 \frac{\varepsilon}{\bar{\varepsilon}_e} - \left(\frac{\varepsilon}{\bar{\varepsilon}_e} \right)^2 + 0,2 \left(\frac{\varepsilon}{\bar{\varepsilon}_e} \right)^3 \right] \tag{E.7}$$

Region 3 for $1,5\bar{\varepsilon}_e < \varepsilon \leq \varepsilon_{max}$

$$\sigma = f_e \left[\frac{f_{max}}{f_e} - 1,5 \left(\frac{f_{max}}{f_e} - 1 \right) \frac{\bar{\varepsilon}_e}{\varepsilon} \right] \tag{E.8}$$

where:

- f_e = conventional limit of elasticity
- f_{max} = tensile strength at the top point of $\sigma - \varepsilon$ curve
- ε_e = strain corresponding to the stress f_e ($\varepsilon_e = 1,5\bar{\varepsilon}_e$)
- ε_{max} = strain corresponding to the stress f_{max}
- E = elastic modulus

(3) In the absence of more accurate evaluation of the above parameters the following values may be assumed:

- f_e = nominal value of f_o (see Section 3)
- f_{max} = nominal value of f_u (see Section 3)
- ε_{max} = $0,5 \varepsilon_u$
- ε_u = nominal value of ultimate strain (see E.3)

E = nominal value of elastic modulus (see Section 3)

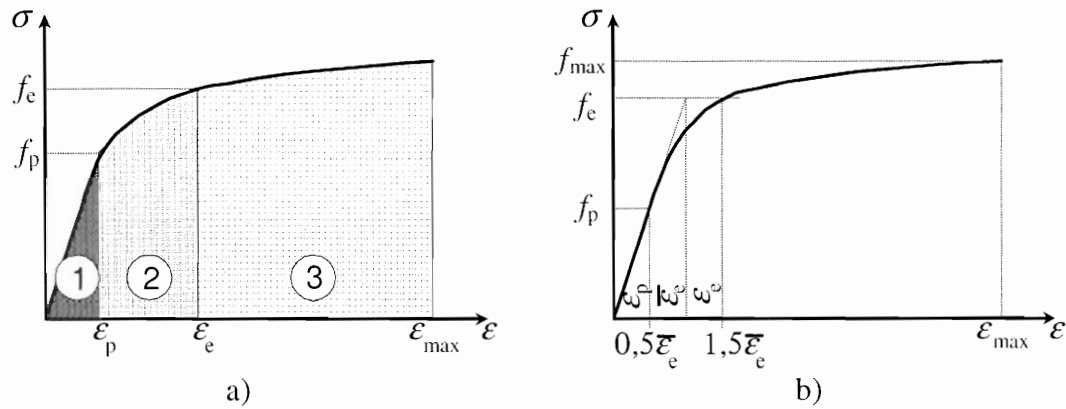

Figure E.3 - Continuous models in the form $\sigma = \alpha(\epsilon)$

E.2.2.2 Continuous models in the form $\epsilon = \epsilon(\sigma)$

(1) For materials of round-house type, as aluminium alloys, the Ramberg-Osgood model may be applied to describe the stress versus strain relationship in the form $\epsilon = \epsilon(\sigma)$. Such model may be given in a general form as follows (see Figure E.4a):

$$\boxed{A_1} \epsilon = \frac{\sigma}{E} + \epsilon_{0,e} \left(\frac{\sigma}{f_e} \right)^n \quad (E.9) \quad \boxed{A_1}$$

where:

- $\boxed{A_1} f_e$ = conventional limit of elasticity $\boxed{A_1}$
- $\epsilon_{0,e}$ = residual strain corresponding to the stress f_e
- n = exponent characterizing the degree of hardening of the curve

(2) In order to evaluate the n exponent, the choice of a second reference stress f_x , in addition to the conventional limit of elasticity f_e , is required. Assuming (Figure E.4b):

- f_x = second reference stress
- $\epsilon_{0,x}$ = residual strain corresponding to the stress f_x

The exponent n is expressed by:

$$\boxed{A_1} n = \frac{\ln(\epsilon_{0,e} / \epsilon_{0,x})}{\ln(f_e / f_x)} \quad (E.10) \quad \boxed{A_1}$$

(3) $\boxed{A_1}$ As conventional limit of elasticity $\boxed{A_1}$, the proof stress f_0 evaluated by means of 0,2% offset method may be assumed, i.e.:

$$f_e = f_0$$

$$\epsilon_{0,e} = 0,002$$

and the model equation become:

$$\boxed{A_1} \epsilon = \frac{\sigma}{E} + 0,002 \left(\frac{\sigma}{f_0} \right)^n \quad \text{and} \quad n = \frac{\ln(0,002 / \epsilon_{0,x})}{\ln(f_0 / f_x)} \quad (E.11) \quad \boxed{A_1}$$

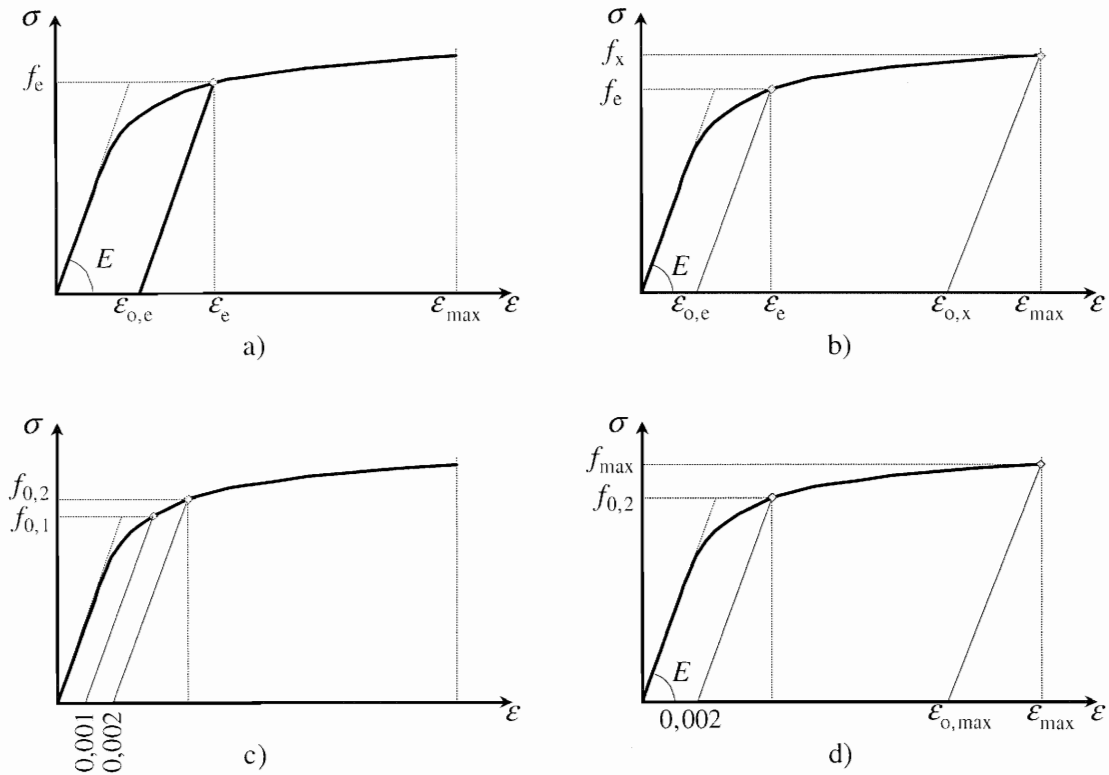

Figure E.4 - Continuous models in the form $\varepsilon = \alpha(\sigma)$

(4) The choice of the second reference point ($f_x - \varepsilon_{o,x}$) should be based on the strain range corresponding to the phenomenon under investigation. The following limit cases may be considered:

a) if the analysis concerns the range of elastic deformations, the proof stress evaluated by means of 0,1% offset method may be assumed as the second reference point (see Figure E.4c), giving:

$$f_x = f_{0,1}$$

$$\varepsilon_{o,x} = 0,001$$

and, therefore,

$$\boxed{A1} \quad n = \frac{\ln 2}{\ln(f_o / f_{0,1})} \quad (E.12) \quad \boxed{A1}$$

b) if the analysis concerns the range of plastic deformations, the tensile stress at the top point of the σ - ε curve may be assumed as the second reference point (see Figure E.4d), giving:

$$f_x = f_{\max}$$

$$\varepsilon_{o,x} = \varepsilon_{o,\max} = \text{residual strain corresponding to the stress } f_{\max}$$

and, therefore,

$$\boxed{A1} \quad n = \frac{\ln(0,002 / \varepsilon_{o,\max})}{\ln(f_o / f_{\max})} \quad (E.13)$$

(5) Based on extensive tests, the following values may be assumed instead of the ones given in E.2.2.2(4):

$$\varepsilon = \frac{\sigma}{E} + 0,002 \left(\frac{\sigma}{f_o} \right)^n \quad (E.14) \quad \boxed{A1}$$

where:

a) elastic range ($f_x = f_p$, $\varepsilon_p = 0,000001$)

$$\boxed{A1} n = \frac{\ln(0,000001/0,002)}{\ln(f_p / f_o)} \quad (E.15) \quad \boxed{A1}$$

where the proportional limit f_p only depends on the value of the f_o yield stress:

$$\boxed{A1} f_p = f_{0,2} - 2\sqrt{10f_{0,2}(\text{N/mm}^2)} \quad \text{if } f_{0,2} > 160 \text{ N/mm}^2 \quad (E.16) \quad \boxed{A1}$$

$$\boxed{A1} f_p = f_{0,2} / 2 \quad \text{if } f_{0,2} \leq 160 \text{ N/mm}^2 \quad (E.17) \quad \boxed{A1}$$

b) plastic range ($f_x = f_u$)

$$\boxed{A1} n = n_p = \frac{\ln(0,002 / \varepsilon_u)}{\ln(f_o / f_u)} \quad (E.18) \quad \boxed{A1}$$

E.3 Approximate evaluation of ε_u

According to experimental data the values of ε_u for the several alloys could be calculated using an analytical expression obtained by means of interpolation of available results. This expression, which provides an upper bound limit for the elongation at rupture, can be synthesised by the following expressions:

$$\boxed{A1} \varepsilon_u = 0,30 - 0,22 \frac{f_o (\text{N/mm}^2)}{400} \quad \text{if } f_o < 400 \text{ N/mm}^2 \quad (E.19) \quad \boxed{A1}$$

$$\boxed{A1} \varepsilon_u = 0,08 \quad \text{if } f_o \geq 400 \text{ N/mm}^2 \quad (E.20) \quad \boxed{A1}$$

NOTE This formulation can be used to quantify the stress-strain model beyond the elastic limit for plastic analysis purposes but it is not relevant for material ductility judgement.

Annex F [informative] - Behaviour of cross-sections beyond the elastic limit

F.1 General

(1) This Annex provides the specifications for estimating the post-elastic behaviour of cross-sections according to the mechanical properties of the material and the geometrical features of the section.

(2) The actual behaviour of cross-sections beyond elastic limit should be considered in whichever type of inelastic analysis, including the simple elastic analysis if redistributions of internal actions are allowed for (see 5.4). In addition, suitable limitation to the elastic strength should be considered also in elastic analysis if slender sections are used.

(3) The choice of the generalized force-displacement relationship for the cross-sections should be consistent with the assumptions for the material law and with the geometrical features of the section itself (see F.3).

(4) The reliability of the assumptions on behaviour of cross-sections can be checked on the basis of tests.

F.2 Definition of cross-section limit states

(1) The behaviour of cross-sections and the corresponding idealization to be used in structural analysis should be related to the capability to reach the limit states listed below, each of them corresponding to a particular assumption on the state of stress acting on the section.

(2) Referring to the global behaviour of a cross-section, regardless of the internal action considered (axial load, bending moment or shear), the following limit states can be defined:

- elastic buckling limit state;
- elastic limit state;
- plastic limit state;
- collapse limit state.

(3) Elastic buckling limit state is related to the strength corresponding to the onset of local elastic instability phenomena in the compressed parts of the section.

(4) Elastic limit state is related to the strength corresponding to the attainment of the conventional elastic limit f_0 of material in the most stressed parts of the section.

(5) Plastic limit state is related to the strength of the section, evaluated by assuming a perfectly plastic behaviour for material with a limit value equal to the conventional elastic limit f_0 , without considering the effect of hardening.

(6) Collapse limit state is related to the actual ultimate strength of the section, evaluated by assuming a distribution of internal stresses accounting for the actual hardening behaviour of material. Since, under this hypothesis, the generalized force-displacement curve is generally increasing, the collapse strength refers to a given limit of the generalized displacement (see F.5).

F.3 Classification of cross-sections according to limit states

(1) Cross-sections can be classified according to their capability to reach the above defined limit states. Such a classification is complementary to that presented at 6.1.4 and may be adopted if the section capabilities for getting into the plastic range need to be specified. In such a sense, referring to a generalized force F versus displacement D relationship, cross-sections can be divided as follows (see Figure F.1):

- ductile sections (Class 1);
- compact sections (Class 2);
- semi-compact sections (Class 3);
- slender sections (Class 4).

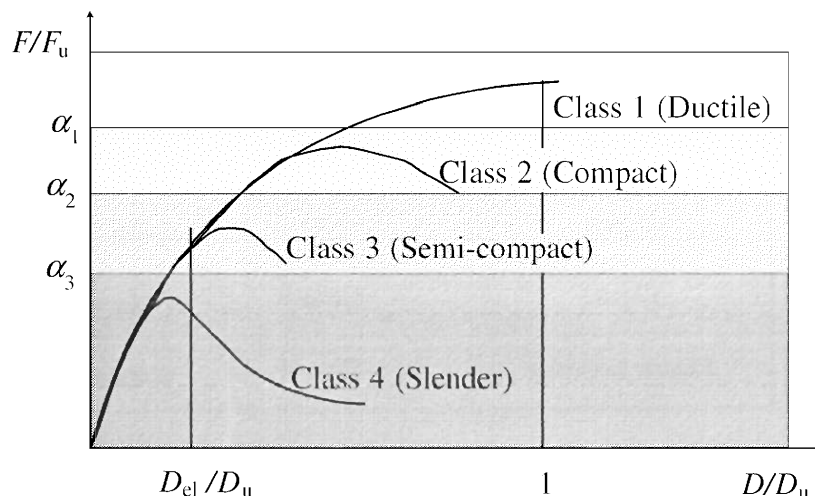

Figure F.1 - Classification of cross-sections

(2) Ductile sections (Class 1) develop the collapse resistance as defined in F.2(6) without having local instability in the section. The full exploitation of the hardening properties of material is allowed until the ultimate value of deformation, depending on the type of alloy, is reached.

(3) Compact sections (Class 2) are capable of developing the plastic limit resistance as defined in F.2(5). The full exploitation of the hardening properties of material is prevented by the onset of plastic instability phenomena.

(4) Semi-compact sections (Class 3) are capable of developing the elastic limit resistance only, as defined in F.2(4), without getting into inelastic range owing to instability phenomena. Only small plastic deformations occur within the section, whose behaviour remains substantially brittle.

(5) Both serviceability and ultimate behaviour of slender sections (Class 4) are governed by the occurring of local buckling phenomena, which cause the ultimate strength of the cross-section to be determined by the elastic buckling limit state, as defined in F.2(3). No plastic deformations are allowed within the section, whose behaviour is remarkably brittle.

F.4 Evaluation of ultimate axial load

(1) The load-bearing resistance of cross-sections under axial compression may be evaluated with reference to the above mentioned limit states, by means of the following practical rules.

(2) The value of axial load for a given limit state can be expressed by the generalized formula:

$$N_{Ed} = \alpha_{N,j} A f_d \quad (\text{F.1})$$

where:

$f_d = f_o / \gamma_{M1}$ the design value of 0,2% proof strength, see 6.1.2

A the net cross sectional area

$\alpha_{N,j}$ a correction factor, given in Table F.1, depending on the assumed limit state.

Table F.1 - Ultimate Axial Load

Axial load	Limit State	Section class	Correction factor
N_u	Collapse	Class 1	$\alpha_{N,1} = f_t / f_d$
N_{pl}	Plastic	Class 2	$\alpha_{N,2} = 1$
N_{el}	Elastic	Class 3	$\alpha_{N,3} = 1$
N_{red}	Elastic buckling	Class 4	$\alpha_{N,4} = A_{eff} / A$

where A_{eff} is the effective cross sectional area, evaluated accounting for local buckling phenomena (see 6.2.4).

$f_t = f_u / \gamma_{M2}$ the design value of ultimate strength, see 6.1.2

(3) The ultimate load bearing resistance of a section under axial load, evaluated according to the above procedure, does not include the overall buckling phenomena, which should be evaluated according to 6.3.1.

(4) If welded sections are involved, a reduced value A_{red} of the net cross sectional area should be used, which should be evaluated according to 6.3.1.

F.5 Evaluation of ultimate bending moment

(1) The load-bearing resistance of cross-sections under bending moment can be evaluated with reference to the above mentioned limit states, by means of the following rules.

(2) The value of bending moment for a given limit state can be expressed by the generalized formula:

$$M_{Rd} = \alpha_{M,j} W_{el} f_d \tag{F.2}$$

where:

$f_d = f_0 / \gamma_{M1}$ the design value of 0,2 % proof strength, see 6.1.2

W_{el} the elastic section modulus

$\alpha_{M,j}$ a correction factor, given in Table F.2, depending on the assumed limit state.

Table F.2 - Ultimate Bending Moment

Bending moment	Limit state	Section class	Correction factor
M_u	Collapse	Class 1	$\alpha_{M,1} = \alpha_5 = 5 - (3,89 + 0,00190n) \alpha_0^{(0,270 + 0,0014n)}$ $\alpha_{M,1} = \alpha_{10} = \alpha_0^{[0,21 \log(1000n)]} 10^{[7,96 \cdot 10^{-2} - 8,09 \cdot 10^{-2} \log(n/10)]}$ (depending on the alloy - see Annex G)
M_{pl}	Plastic	Class 2	$\alpha_{M,2} = \alpha_0 = W_{pl} / W_{el}$
M_{el}	Elastic	Class 3	$\alpha_{M,3} = 1$
M_{red}	Elastic buckling	Class 4	$\alpha_{M,4} = W_{eff} / W_{el}$ (see 6.2.5)

where:

$n = n_p$ is the exponent of Ramberg-Osgood law representing the material behaviour in plastic range (see Annex E)

α_5 and α_{10} , are the section generalized shape factors corresponding respectively to ultimate curvature

values $\chi_u = 5\chi_{el}$ and $10\chi_{el}$, χ_{el} being the elastic limit curvature (See Annex G)

α_0 is the geometrical shape factor

W_{pl} is the section plastic modulus

W_{eff} is the effective section resistance modulus evaluated accounting for local buckling phenomena (see 6.2.5).

(3) If welded sections are involved, reduced values $W_{eff,haz}$ and $W_{pl,haz}$ of section resistance and plastic modulus should be used, evaluated by accounting for HAZ (See 6.2.5).

(4) The evaluation of the correction factor $\alpha_{M,j}$ for a welded section of class 1 may be done by means of the following formula:

$$\alpha_{M,red} = \psi \left(\frac{W_{pl,haz}}{W_{el}} \right) \quad (F.3)$$

where:

$\psi = \alpha_{M,1} / \alpha_{M,2}$, $\alpha_{M,1}$ and $\alpha_{M,2}$ being the correction factors for unwelded sections of class 1 and 2, respectively.

Annex G [informative] - Rotation capacity

(1) The provisions given in this Annex G apply to class 1 cross-sections in order to define their nominal ultimate resistance. The provisions may also be used for the evaluation of the ultimate resistance of class 2 and class 3 sections, provided it is demonstrated that the rotation capacity is reached without local buckling of the sections

(2) If no reliance can be placed on the ductility properties or if no specific test can be performed on the material, the ultimate values of M_u should be referred to a conventional ultimate bending curvature given by:

$$\chi_u = \zeta \chi_{el} \quad (G.1)$$

where

ζ is a ductility factor depending on the type of alloy and χ_{el} is conventionally assumed equal to the elastic bending curvature $\chi_{0,2}$, which corresponds to the attainment of the proof stress f_0 in the most stressed fibres.

(3) From the ductility point of view the common alloys can be subdivided into two groups (see also Annex H):

- brittle alloys, having $4 \% \leq \varepsilon_u \leq 8 \%$, for which it can be assumed $\zeta = 5$;
- ductile alloys, having $\varepsilon_u \geq 8 \%$, for which it can be assumed $\zeta = 10$.

(4) The evaluation of elastic and post-elastic behaviour of the cross-section may be done through the moment-curvature relationship, written in the Ramberg-Osgood form:

$$\frac{\chi}{\chi_{0,2}} = \frac{M}{M_{0,2}} + k \left[\frac{M}{M_{0,2}} \right]^m \quad (G.2)$$

where:

- $M_{0,2}$ and $\chi_{0,2}$ are the conventional elastic limit values corresponding to the attainment of the proof stress f_0
- m and k are numerical parameters which for sections in pure bending are given by:

$$m = \frac{\ln[(10 - \alpha_{10})(5 - \alpha_5)]}{\ln(\alpha_{10} / \alpha_5)} \quad (G.3)$$

$$k = \frac{5 - \alpha_5}{\alpha_5 m} = \frac{10 - \alpha_{10}}{\alpha_{10} m} \quad (G.4)$$

- α_5 and α_{10} being the generalized shape factors corresponding to curvature values equal to 5 and 10 times the elastic curvature, respectively.

(5) The stable part of the rotation capacity R is defined as the ratio between the plastic rotation at the collapse limit state $\theta_p = \theta_u - \theta_{el}$ to the limit elastic rotation θ_{el} (Figure G.1):

$$R = \frac{\theta_p}{\theta_{el}} = \frac{\theta_u - \theta_{el}}{\theta_{el}} = \frac{\theta_u}{\theta_{el}} - 1 \quad (G.5)$$

where

θ_u is the maximum plastic rotation corresponding to the ultimate curvature χ_u .

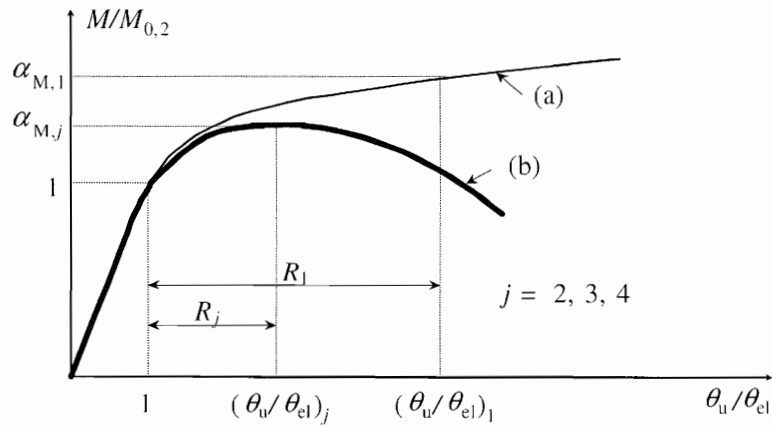

(a) Class 1 sections; (b) class 2, 3 and 4 sections

Figure G.1 - Definition of rotation capacity

(6) The rotation capacity R may be calculated through the approximate formula:

$$R = \alpha_{M,j} \left(1 + 2 \frac{k \alpha_{M,j}^{m-1}}{m+1} \right) - 1 \quad (\text{G.6})$$

with m and k defined before.

The value of $\alpha_{M,j}$ is given in Table F.2 for the different behavioural classes.

(7) If the material exponent n is known (see Annex H), an approximate evaluation of α_5 and α_{10} can be done through the formulas:

$$\alpha_5 = 5 - (3,89 + 0,00190n) / \alpha_0^{(0,270 + 0,0014n)} \quad (\text{G.7})$$

$$\alpha_{10} = \alpha_0^{[0,21 \log(1000n)]} \times 10^{[7,96 \times 10^{-2} - 8,09 \times 10^{-2} \log(n/10)]} \quad (\text{G.8})$$

$\alpha_0 = W_p/W$ being the geometrical shape factor.

In the absence of more refined evaluations, the value $n = n_p$ should be assumed (Annex H).

Annex H [informative] - Plastic hinge method for continuous beams

(1) The provisions given in this Annex H apply to cross-sections of class 1 in structures where collapse is defined by a number of cross-sections that are reaching an ultimate strain. The provisions may be used also for structures with cross-sections of class 2 and class 3 provided that the effect of local buckling of the sections is taken into account for determination of the load bearing capacity and the available ductility of the component. See also Annex G

(2) The concentrated plasticity method of global analysis, hereafter referred to as “plastic hinge method”, commonly adopted for steel structures, may be applied to aluminium structures as well, provided that the structural ductility is sufficient to enable the development of full plastic mechanisms. See (3), (4) and (5).

(3) Plastic hinge method should not be used for members with transverse welds on the tension side of the member at the plastic hinge location.

(4) Adjacent to plastic hinge locations, any fastener holes in tension flange should satisfy

$$A_{f,\text{net}} 0,9 f_u / \gamma_{M2} \geq A_f f_o / \gamma_{M1} \quad (\text{H.1})$$

for a distance each way along the member from the plastic hinge location of not less than the greater of:

- $2h_w$, where h_w is the clear depth of the web at the plastic hinge location
- the distance to the adjacent point at which the moment in the member has fallen to 0,8 times the moment resistance at the point concerned.

A_f is the area of the tension flange and $A_{f,\text{net}}$ is the net area in the section with fastener holes.

(5) These rules are not applicable to beams where the cross section vary along their length.

(6) If applying the plastic hinge method to aluminium structures both ductility and hardening behaviour of the alloy have to be taken into account. This leads to a correction factor η of the conventional yield stress, see (10).

(7) With regard to ductility, two groups of alloys are defined, depending on whether the conventional curvature limits $5\chi_e$ and $10\chi_e$ are reached or not (see also Annex G):

- Brittle alloys (for which $4 \% \leq \epsilon_u \leq 8 \%$),

if the ultimate tensile deformation is sufficient to develop a conventional ultimate bending curvature χ_u equal at least to $5\chi_e$;

- Ductile alloys (for which $\epsilon_u > 8 \%$),

if the ultimate tensile deformation is sufficient to develop a conventional ultimate bending curvature χ_u equal or higher than $10\chi_e$.

(8) Assuming an elastic- (or-rigid-) perfectly plastic law for the material (see Annex G), the ultimate bending moment of a given cross section at plastic hinge location is conventionally calculated as a fully plastic moment given by:

$$M_u = \alpha_0 \eta f_o W_{el} \quad (\text{H.2})$$

where:

η is the previously defined correction factor;

W_{el} is the section elastic modulus.

(9) Assuming a hardening law for the material (see Annex G), the ultimate bending moment of a given cross section at plastic hinge location is conventionally calculated in the following way:

$$M_u = \alpha_\xi \eta f_o W_{el} \tag{H.3}$$

where, in addition to η and W_{el} previously defined, the index ξ is equal to 5 or 10 depending on the alloy ductility features set out in (4) (for the definition of α_5 and α_{10} refer to Annex F and G):

(10) The correction coefficient η is fitted in such a way that the plastic hinge analysis provides the actual ultimate load bearing capacity of the structure, according to the available ductility of the alloy. In general, η is expressed by:

$$\eta = \frac{1}{a - b/n_p^c}, \text{ but } \eta \leq \frac{f_u / \gamma_{M2}}{f_o / \gamma_{M1}} \tag{H.4}$$

where n_p is the alloy Ramberg-Osgood hardening exponent evaluated in plastic range (see 3.2.2). For structures made of beams in bending, the coefficients a , b and c of equation [A1] H.4 [A1] are provided in Table H.1. Values of the correction coefficient η are shown in Figure H.1.

(11) The global safety factor evaluated through plastic hinge methods applied with $\eta < 1$ should be not higher than that evaluated through a linear elastic analysis. If this occurs the results of elastic analysis should be used.

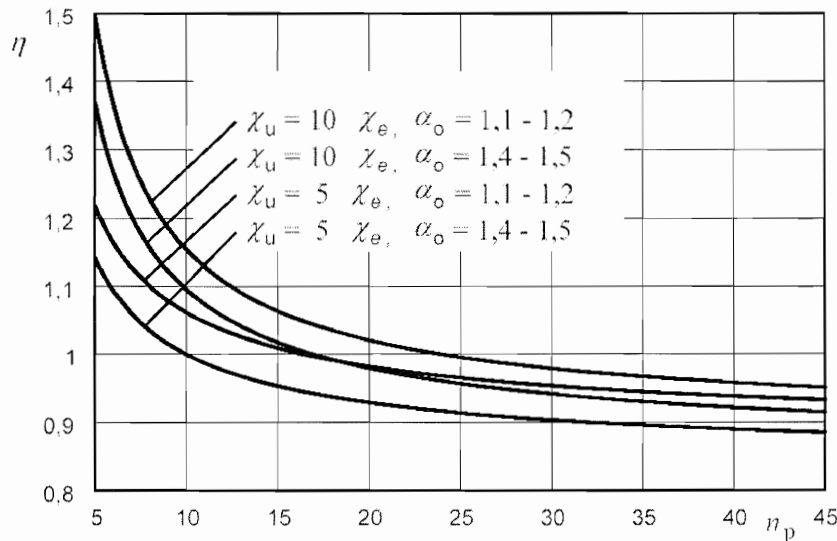

Figure H.1 - Value of the correction coefficient η

Table H.1 - Values of coefficients a , b and c .

Coefficients of the law: $\eta = \frac{1}{a - b/n_p^c}$	$\alpha_0 = 1,4 - 1,5$		$\alpha_0 = 1,1 - 1,2$	
	Brittle alloys ($\chi_u = 5\chi_e$)	Ductile alloys ($\chi_u = 10\chi_e$)	Brittle alloys ($\chi_u = 5\chi_e$)	Ductile alloys ($\chi_u = 10\chi_e$)
a	1,20	1,18	1,15	1,13
b	1,00	1,50	0,95	1,70
c	0,70	0,75	0,66	0,81

Annex I [informative] - Lateral torsional buckling of beams and torsional or torsional-flexural buckling of compressed members

I.1 Elastic critical moment and slenderness

I.1.1 Basis

(1) The elastic critical moment for lateral-torsional buckling of a beam of uniform symmetrical cross-section with equal flanges, under standard conditions of restraint at each end and subject to uniform moment in plane going through the shear centre is given by:

$$M_{cr} = \frac{\pi^2 EI_z}{L^2} \sqrt{\frac{L^2 GI_t}{\pi^2 EI_z} + \frac{I_w}{I_z}} = \frac{\pi \sqrt{EI_z GI_t}}{L} \sqrt{1 + \frac{\pi^2 EI_w}{L^2 GI_t}} \quad (\text{I.1})$$

where:

$$G = \frac{E}{2(1+\nu)}$$

I_t is the torsion constant

I_w is the warping constant

I_z is the second moment of area about the minor axis

L is the length of the beam between points that have lateral restraint

ν is the Poisson ratio

(2) The standard conditions of restraint at each end are:

- restrained against lateral movement, free to rotate on plan ($k_z = 1$);
- restrained against rotation about the longitudinal axis, free to warp ($k_w = 1$);
- restrained against movement in plane of loading, free to rotate in this plane ($k_y = 1$).

I.1.2 General formula for beams with uniform cross-sections symmetrical about the minor or major axis

(1) In the case of a beam of uniform cross-section which is symmetrical about the minor axis, for bending about the major axis the elastic critical moment for lateral-torsional buckling is given by the general formula:

$$M_{cr} = \mu_{cr} \frac{\pi \sqrt{EI_z GI_t}}{L} \quad (\text{I.2})$$

where relative non-dimensional critical moment μ_{cr} is

$$\mu_{cr} = \frac{C_1}{k_z} \left[\sqrt{1 + \kappa_{wt}^2 + (C_2 \zeta_g - C_3 \zeta_j)^2} - (C_2 \zeta_g - C_3 \zeta_j) \right], \quad (\text{I.3})$$

non-dimensional torsion parameter is $\kappa_{wt} = \frac{\pi}{k_w L} \sqrt{\frac{EI_w}{GI_t}}$

relative non-dimensional coordinate of the point of load application related to shear centre $\zeta_g = \frac{\pi z_g}{k_z L} \sqrt{\frac{EI_z}{GI_t}}$

relative non-dimensional cross-section mono-symmetry parameter $\zeta_j = \frac{\pi z_j}{k_z L} \sqrt{\frac{EI_z}{GI_t}}$

where:

C_1 , C_2 and C_3 are factors depending mainly on the loading and end restraint conditions (See Table I.1 and I.2)

k_z and k_w are buckling length factors

$$z_g = z_a - z_s$$

$$z_j = z_s - \frac{0,5}{I_y} \int_A (y^2 + z^2) z dA$$

z_a is the coordinate of the point of load application related to centroid (see Figure I.1)

z_s is the coordinate of the shear centre \bar{A}_1 related to centroid

z_g is the coordinate of the point of load application related to shear centre \bar{A}_1 .

NOTE 1 See I.1.2 (7) and (8) for sign conventions and I.1.4 (2) for approximations for z_j .

NOTE 2 $z_j = 0$ ($y_j = 0$) for cross sections with y-axis (z-axis) being axis of symmetry.

NOTE 3 The following approximation for z_j can be used:

$$z_j = 0,45\psi_f h_s \left(1 + \frac{c}{2h_f} \right) \quad (I.4)$$

where:

c is the depth of a lip

h_f is the distance between \bar{A}_1 centrelines \bar{A}_1 of the flanges.

$$\psi_f = \frac{I_{fc} - I_{ft}}{I_{fc} + I_{ft}} \quad (I.4b)$$

I_{fc} is the second moment of area of the compression flange about the minor axis of the section

I_{ft} is the second moment of area of the tension flange about the minor axis of the section

h_s is the distance between the shear centre of the upper flange and shear centre of the bottom flange (S_u and S_b in Figure I.1).

For an I-section with unequal flanges without lips and as an approximation also with lips:

$$I_w = (1 - \psi_f^2) I_z (h_s / 2)^2 \quad (I.5)$$

(2) The buckling length factors k_z (for lateral bending boundary conditions) and k_w (for torsion boundary condition) vary from 0,5 for both beam ends fixed to 1,0 for both ends simply supported, with 0,7 for one end fixed (left or right) and one end simply supported (right or left).

(3) The factor k_z refers to end rotation on plan. It is analogous to the ratio L_{cr}/L for a compression member.

(4) The factor k_w refers to end warping. Unless special provision for warping fixity of both beam ends ($k_w = 0,5$) is made, k_w should be taken as 1,0.

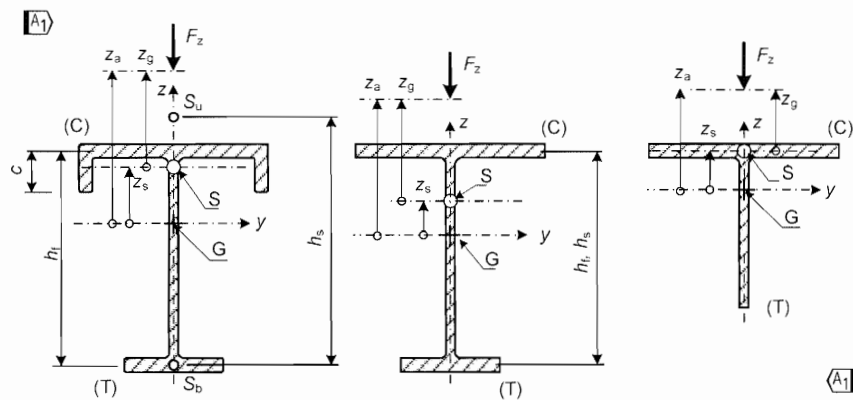

(C) Compression side, (T) tension side, S shear centre, G gravity centre
S_u, S_b is shear centre of upper and bottom flange

Figure I.1 - Notation and sign convention for beams under gravity loads (F_z) or for cantilevers under uplift loads ($-F_z$)

(5) Values of C_1 , C_2 and C_3 are given in Tables I.1 and I.2 for various load cases, as indicated by the shape of the bending moment diagram over the length L between lateral restraints. Values are given in Table I.1 corresponding to various values of k_z and in Table I.2 also corresponding to various values of k_w .

(6) For cases with $k_z = 1,0$ the value of C_1 for any ratio of end moment loading as indicated in Table I.1, is given approximately by:

$$C_1 = (0.310 + 0.428\psi + 0.262\psi^2)^{-0.5} \quad (I.6)$$



(7) The sign convention for determining z and z_j , see Figure I.1, is:

- coordinate z is positive for the compression flange. When determining z_j from formula in I.1.2(1), positive coordinate z goes upwards for beams under gravity loads or for cantilevers under uplift loads, and goes downwards for beams under uplift loads or cantilevers under gravity loads
- sign of z_j is the same as the sign of cross-section mono-symmetry factor ψ_f in I.1.4(1). Take the cross section located at the M-side in the case of moment loading, Table I.1, and the cross-section located in the middle of the beam span in the case of transverse loading, Table I.2.

(8) The sign convention for determining z_g is:

- for gravity loads z_g is positive for loads applied above the shear centre
- in the general case z_g is positive for loads acting towards the shear centre from their point of application.

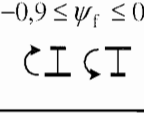
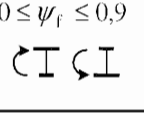
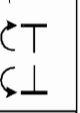
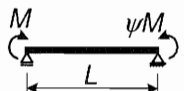
Table I.1 - Values of factors C_1 and C_3 corresponding to various end moment ratios ψ , values of buckling length factor k_z and cross-section parameters ψ_f and κ_{wt} . End moment loading of the simply supported beam with buckling length factors $k_y = 1$ for major axis bending and $k_w = 1$ for torsion

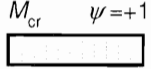
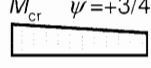
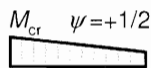
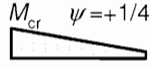
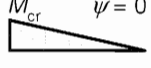
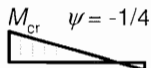
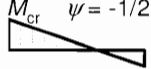
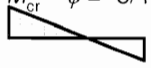
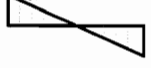
Loading and support conditions. Cross-section monosymmetry factor ψ_f	Bending moment diagram. End moment ratio ψ . M -side ψM -side	k_z ²⁾	Values of factors					
			C_1 ¹⁾		C_3			
			$C_{1,0}$	$C_{1,1}$	$\psi_f = -1$ 	$-0,9 \leq \psi_f \leq 0$ 	$0 \leq \psi_f \leq 0,9$ 	$\psi_f = 1$ 
 $k_y = 1, k_w = 1$ Beam M -side:  $\psi_f \geq 0$  $\psi_f < 0$	 $M_{cr} \quad \psi = +1$	1,0	1,000	1,000	1,000			
		0,7L	1,016	1,100	1,025		1,000	
		0,7R	1,016	1,100	1,025		1,000	
		0,5	1,000	1,127	1,019			
	 $M_{cr} \quad \psi = +3/4$	1,0	1,139	1,141	1,000			
		0,7L	1,210	1,313	1,050		1,000	
		0,7R	1,109	1,201	1,000			
		0,5	1,139	1,285	1,017			
	 $M_{cr} \quad \psi = +1/2$	1,0	1,312	1,320	1,150	1,000		
		0,7L	1,480	1,616	1,160		1,000	
		0,7R	1,213	1,317	1,000			
		0,5	1,310	1,482	1,150	1,000		
 $M_{cr} \quad \psi = +1/4$	1,0	1,522	1,551	1,290	1,000			
	0,7L	1,853	2,059	1,600	1,260	1,000		
	0,7R	1,329	1,467	1,000				
	0,5	1,516	1,730	1,350	1,000			
 $M_{cr} \quad \psi = 0$	1,0	1,770	1,847	1,470	1,000			
	0,7L	2,331	2,683	2,000	1,420	1,000		
	0,7R	1,453	1,592	1,000				
	0,5	1,753	2,027	1,500	1,000			
 $M_{cr} \quad \psi = -1/4$	1,0	2,047	2,207	1,65	1,000	0,850		
	0,7L	2,827	3,322	2,40	1,550	0,850	-0,30	
	0,7R	1,582	1,748	1,38	0,850	0,700	0,20	
	0,5	2,004	2,341	1,75	1,000	0,650	-0,25	
 $M_{cr} \quad \psi = -1/2$	1,0	2,331	2,591	1,85	1,000	$1,3 - 1,2\psi_f$	-0,70	
	0,7L	3,078	3,399	2,70	1,450	$1 - 1,2\psi_f$	-1,15	
	0,7R	1,711	1,897	1,45	0,780	$0,9 - 0,75\psi_f$	-0,53	
	0,5	2,230	2,579	2,00	0,950	$0,75 - \psi_f$	-0,85	
 $M_{cr} \quad \psi = -3/4$	1,0	2,547	2,852	2,00	1,000	$0,55 - \psi_f$	-1,45	
	0,7L	2,592	2,770	2,00	0,850	$0,23 - 0,9\psi_f$	-1,55	
	0,7R	1,829	2,027	1,55	0,700	$0,68 - \psi_f$	-1,07	
	0,5	2,352	2,606	2,00	0,850	$0,35 - \psi_f$	-1,45	
 $M_{cr} \quad \psi = -1$	1,0	2,555	2,733	2,00	$-\psi_f$		-2,00	
	0,7L	1,921	2,103	1,55	0,380	-0,580	-1,55	
	0,7R	1,921	2,103	1,55	0,580	-0,380	-1,55	
	0,5	2,223	2,390	1,88	$0,125 - 0,7\psi_f$	$-0,125 - 0,7\psi_f$	-1,88	

1) $C_1 = C_{1,0} + (C_{1,1} - C_{1,0})\kappa_{wt} \leq C_{1,1}$, ($C_1 = C_{1,0}$ for $\kappa_{wt} = 0$, $C_1 = C_{1,1}$ for $\kappa_{wt} \geq 1$)

2) 0,7L = left end fixed, 0,7R = right end fixed

Table I.2 - Values of factors C_1 , C_2 and C_3 corresponding to various transverse loading cases, values of buckling length factors k_y , k_z , k_w , cross-section monosymmetry factor ψ_f and torsion parameter κ_{wt} .

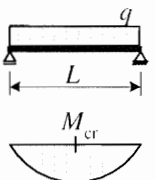
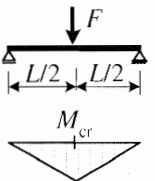
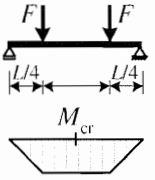
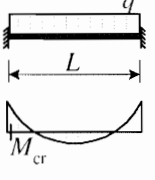
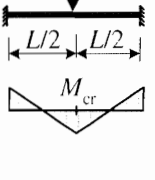
Loading and support conditions	Buckling length factors			Values of factors							
	k_y	k_z	k_w	$C_1^{1)}$		C_2			C_3		
				$C_{1,0}$	$C_{1,1}$	\perp $\psi_f = -1$	I I I $-0.9 \leq \psi_f \leq 0.9$	T $\psi_f = 1$	\perp $\psi_f = -1$	I I I $-0.9 \leq \psi_f \leq 0.9$	T $\psi_f = 1$
	1	1	1	1,127	1,132	0,33	0,459	0,50	0,93	0,525	0,38
	1	1	0,5	1,128	1,231	0,33	0,391	0,50	0,93	0,806	0,38
	1	0,5	1	0,947	0,997	0,25	0,407	0,40	0,84	0,478	0,44
	1	0,5	0,5	0,947	0,970	0,25	0,310	0,40	0,84	0,674	0,44
	1	1	1	1,348	1,363	0,52	0,553	0,42	1,00	0,411	0,31
	1	1	0,5	1,349	1,452	0,52	0,580	0,42	1,00	0,666	0,31
	1	0,5	1	1,030	1,087	0,40	0,449	0,42	0,80	0,338	0,31
	1	0,5	0,5	1,031	1,067	0,40	0,437	0,42	0,80	0,516	0,31
	1	1	1	1,038	1,040	0,33	0,431	0,39	0,93	0,562	0,39
	1	1	0,5	1,039	1,148	0,33	0,292	0,39	0,93	0,878	0,39
	1	0,5	1	0,922	0,960	0,28	0,404	0,30	0,88	0,539	0,50
	1	0,5	0,5	0,922	0,945	0,28	0,237	0,30	0,88	0,772	0,50
						$\psi_f = -1$	$-0,5 \leq \psi_f \leq 0,5$	$\psi_f = 1$	$\psi_f = -1$	$-0,5 \leq \psi_f \leq 0,5$	$\psi_f = 1$
	0,5	1	1	2,576	2,608	1,00	1,562	0,15	1,00	-0,859	-1,99
	0,5	0,5	1	1,490	1,515	0,56	0,900	0,08	0,61	-0,516	-1,20
	0,5	0,5	0,5	1,494	1,746	0,56	0,825	0,08	0,61	0,002712	-1,20
	0,5	1	1	1,683	1,726	1,20	1,388	0,07	1,15	-0,716	-1,35
	0,5	0,5	1	0,936	0,955	0,69	0,763	0,03	0,64	-0,406	-0,76
	0,5	0,5	0,5	0,937	1,057	0,69	0,843	0,03	0,64	-0,0679	-0,76

1) $C_1 = C_{1,0} + (C_{1,1} - C_{1,0})\kappa_{wt} \leq C_{1,1}$, ($C_1 = C_{1,0}$ for $\kappa_{wt} = 0$, $C_1 = C_{1,1}$ for $\kappa_{wt} \geq 1$).

2) Parameter ψ_f refers to the middle of the span.

3) Values of critical moments M_{cr} refer to the cross section, where M_{max} is located

I.1.3 Beams with uniform cross-sections symmetrical about major axis, centrally symmetric and doubly symmetric cross-sections

(1) For beams with uniform cross-sections symmetrical about major axis, centrally symmetric and doubly symmetric cross-sections loaded perpendicular to the major axis in the plane going through the shear centre, Figure I.2, $z_j = 0$, thus

$$\mu_{cr} = \frac{C_1}{k_z} \left[\sqrt{1 + \kappa_{wt}^2 + (C_2 \zeta_g)^2} - C_2 \zeta_g \right] \quad (I.7)$$

(2) For end-moment loading $C_2 = 0$ and for transverse loads applied at the shear centre $z_g = 0$. For these cases:

$$\mu_{cr} = \frac{C_1}{k_z} \sqrt{1 + \kappa_{wt}^2} \quad (I.8)$$

(3) If also $\kappa_{wt} = 0$: $\mu_{cr} = C_1 / k_z$

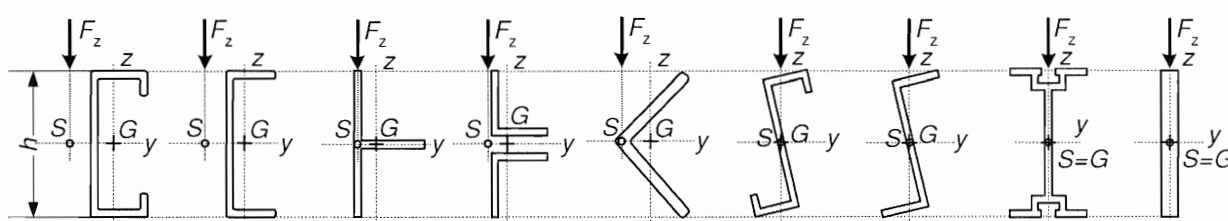

Figure I.2 - Beams with uniform cross-sections symmetrical about major axis, centrally symmetric and doubly symmetric cross-sections

(4) For beams supported on both ends ($k_y = 1$, $k_z = 1$, $0,5 \leq k_w \leq 1$) or for beam segments laterally restrained on both ends, which are under any loading (e.g. different end moments combined with any transverse loading), the following value of factor C_1 may be used in the above two formulas given in I.1.3 (2) and (3) to obtain approximate value of critical moment:

$$C_1 = \frac{1,7 |M_{max}|}{\sqrt{M_{0,25}^2 + M_{0,5}^2 + M_{0,75}^2}} \leq 2,5, \quad (I.9)$$

where

M_{max} is maximum design bending moment,

$M_{0,25}$, $M_{0,75}$ are design bending moments at the quarter points and

$M_{0,5}$ is design bending moment at the midpoint of the beam or beam segment with length equal to the distance between adjacent cross-sections which are laterally restrained.

(5) Factor C_1 defined by (I.9) may be used also in formula (I.7), but only in combination with relevant value of factor C_2 valid for given loading and boundary conditions. This means that for the six cases in Table I.2 with boundary condition $k_y = 1$, $k_z = 1$, $0,5 \leq k_w \leq 1$, as defined above, the value $C_2 = 0,5$ may be used together with (I.9) in (I.7) as an approximation.

(6) In the case of continuous beam the following approximate method may be used. The effect of lateral continuity between adjacent segments are ignored and each segment is treated as being simply supported laterally. Thus the elastic buckling of each segment is analysed for its in-plane moment distribution (formula (I.9) for C_1 may be used) and for an buckling length equal to the segment length L . The lowest of critical moments computed for each segment is taken as the elastic critical load set of the continuous beam. This method produces a lower bound estimate.

1.1.4 Cantilevers with uniform cross-sections symmetrical about the minor axis

(1) In the case of a cantilever of uniform cross-section, which is symmetrical about the minor axis, for bending about the major axis the elastic critical moment for lateral-torsional buckling is given by the formula (I.2), where relative non-dimensional critical moment μ_{cr} is given in Table I.3 and I.4. In table I.3 and I.4 non-linear interpolation should be used.

(2) The sign convention for determining z_j and z_g is given in I.1.2(7) and (8).

Table I.3 - Relative non-dimensional critical moment μ_{cr} for cantilever ($k_y = k_z = k_w = 2$) loaded by concentrated end load F .

Loading and support conditions	$\frac{\pi}{L} \sqrt{\frac{EI_w}{GI_t}} = k_w \kappa_{wt} = \kappa_{wt0}$	$\frac{\pi z_g}{L} \sqrt{\frac{EI_z}{GI_t}} = k_z \zeta_g = \zeta_g$	$\frac{\pi z_j}{L} \sqrt{\frac{EI_z}{GI_t}} = k_z \zeta_j = \zeta_{j0}$						
			$\begin{matrix} \downarrow (T) \\ \uparrow (C) \end{matrix}$	$\begin{matrix} \uparrow (C) \\ \downarrow (T) \end{matrix}$					
			-4	-2	-1	0	1	2	4
	0	4	0,107	0,156	0,194	0,245	0,316	0,416	0,759
		2	0,123	0,211	0,302	0,463	0,759	1,312	4,024
		0	0,128	0,254	0,478	1,280	3,178	5,590	10,730
		-2	0,129	0,258	0,508	1,619	3,894	6,500	11,860
		-4	0,129	0,258	0,511	1,686	4,055	6,740	12,240
	0,5	4	0,151	0,202	0,240	0,293	0,367	0,475	0,899
		2	0,195	0,297	0,393	0,560	0,876	1,528	5,360
		0	0,261	0,495	0,844	1,815	3,766	6,170	11,295
		-2	0,329	0,674	1,174	2,423	4,642	7,235	12,595
		-4	0,364	0,723	1,235	2,529	4,843	7,540	13,100
	1	4	0,198	0,257	0,301	0,360	0,445	0,573	1,123
		2	0,268	0,391	0,502	0,691	1,052	1,838	6,345
		0	0,401	0,750	1,243	2,431	4,456	6,840	11,920
		-2	0,629	1,326	2,115	3,529	5,635	8,115	13,365
		-4	0,777	1,474	2,264	3,719	5,915	8,505	13,960
	2	4	0,335	0,428	0,496	0,588	0,719	0,916	1,795
		2	0,461	0,657	0,829	1,111	1,630	2,698	7,815
		0	0,725	1,321	2,079	3,611	5,845	8,270	13,285
		-2	1,398	3,003	4,258	5,865	7,845	10,100	15,040
		-4	2,119	3,584	4,760	6,360	8,385	10,715	15,825
4	4	0,845	1,069	1,230	1,443	1,739	2,168	3,866	
	2	1,159	1,614	1,992	2,569	3,498	5,035	10,345	
	0	1,801	3,019	4,231	6,100	8,495	11,060	16,165	
	-2	3,375	6,225	8,035	9,950	11,975	14,110	18,680	
	-4	5,530	8,130	9,660	11,375	13,285	15,365	19,925	

a) For $z_j = 0, z_g = 0$ and $\kappa_{wt0} \leq 8$: $\mu_{cr} = 1,27 + 1,14 \kappa_{wt0} + 0,017 \kappa_{wt0}^2$.

b) For $z_j = 0, -4 \leq \zeta_g \leq 4$ and $\kappa_{wt} \leq 4$, μ_{cr} may be calculated also from formulae (I.7) and (I.8), where the following approximate values of the factors C_1, C_2 should be used for the cantilever under tip load F :

$$C_1 = 2,56 + 4,675 \kappa_{wt} - 2,62 \kappa_{wt}^2 + 0,5 \kappa_{wt}^3, \quad \text{if } \kappa_{wt} \leq 2$$

$$C_1 = 5,55 \quad \text{if } \kappa_{wt} > 2$$

$$C_2 = 1,255 + 1,566 \kappa_{wt} - 0,931 \kappa_{wt}^2 + 0,245 \kappa_{wt}^3 - 0,024 \kappa_{wt}^4, \quad \text{if } \zeta_g \geq 0$$

$$C_2 = 0,192 + 0,585 \kappa_{wt} - 0,054 \kappa_{wt}^2 - (0,032 + 0,102 \kappa_{wt} - 0,013 \kappa_{wt}^2) \zeta_g, \quad \text{if } \zeta_g < 0$$

Table I.4 - Relative non-dimensional critical moment μ_{cr} for cantilever ($k_y = k_z = k_w = 2$) loaded by uniformly distributed load q

Loading and support conditions	$\frac{\pi}{L} \sqrt{\frac{EI_w}{GI_t}} = \kappa_{wt} = \kappa_{wt0}$	$\frac{\pi z_g}{L} \sqrt{\frac{EI_z}{GI_t}} = \kappa_z \zeta_g = \zeta_{g0}$	$\frac{\pi z_j}{L} \sqrt{\frac{EI_z}{GI_t}} = k_z \zeta_j = \zeta_{j0}$						
			$\begin{matrix} \downarrow (T) \\ \uparrow (C) \end{matrix}$	$\begin{matrix} \uparrow (C) \\ \downarrow (T) \end{matrix}$					$\begin{matrix} \uparrow (C) \\ \downarrow (T) \end{matrix}$
			-4	-2	-1	0	1	2	4
	0	4	0,113	0,173	0,225	0,304	0,431	0,643	1,718
		2	0,126	0,225	0,340	0,583	1,165	2,718	13,270
		0	0,132	0,263	0,516	2,054	6,945	12,925	25,320
		-2	0,134	0,268	0,537	3,463	10,490	17,260	30,365
		-4	0,134	0,270	0,541	4,273	12,715	20,135	34,005
	0,5	4	0,213	0,290	0,352	0,443	0,586	0,823	2,046
		2	0,273	0,421	0,570	0,854	1,505	3,229	14,365
		0	0,371	0,718	1,287	3,332	8,210	14,125	26,440
		-2	0,518	1,217	2,418	6,010	12,165	18,685	31,610
		-4	0,654	1,494	2,950	7,460	14,570	21,675	35,320
	1	4	0,336	0,441	0,522	0,636	0,806	1,080	2,483
		2	0,449	0,663	0,865	1,224	1,977	3,873	15,575
		0	0,664	1,263	2,172	4,762	9,715	15,530	27,735
		-2	1,109	2,731	4,810	8,695	14,250	20,425	33,075
		-4	1,623	3,558	6,025	10,635	16,880	23,555	36,875
	2	4	0,646	0,829	0,965	1,152	1,421	1,839	3,865
		2	0,885	1,268	1,611	2,185	3,282	5,700	18,040
		0	1,383	2,550	4,103	7,505	12,770	18,570	30,570
		-2	2,724	6,460	9,620	13,735	18,755	24,365	36,365
		-4	4,678	8,635	11,960	16,445	21,880	27,850	40,400
4	4	1,710	2,168	2,500	2,944	3,565	4,478	8,260	
	2	2,344	3,279	4,066	5,285	7,295	10,745	23,150	
	0	3,651	6,210	8,845	13,070	18,630	24,625	36,645	
	-2	7,010	13,555	17,850	22,460	27,375	32,575	43,690	
	-4	12,270	18,705	22,590	26,980	31,840	37,090	48,390	

a) For $z_j = 0$, $z_g = 0$ and $\kappa_{wt0} \leq 8$: $\mu_{cr} = 2,04 + 2,68 \kappa_{wt0} + 0,021 \kappa_{wt0}^2$.

b) For $z_j = 0$, $-4 \leq \zeta_g \leq 4$ and $\kappa_{wt} \leq 4$, μ_{cr} may be calculated also from formula (I.7) and (I.8),

where the following approximate values of the factors C_1 , C_2 should be used for the cantilever under uniform load q :

$$C_1 = 4,11 + 11,2 \kappa_{wt} - 5,65 \kappa_{wt}^2 + 0,975 \kappa_{wt}^3, \quad \text{if } \kappa_{wt} \leq 2$$

$$C_1 = 12 \quad \text{if } \kappa_{wt} > 2$$

$$C_2 = 1,661 + 1,068 \kappa_{wt} - 0,609 \kappa_{wt}^2 + 0,153 \kappa_{wt}^3 - 0,014 \kappa_{wt}^4, \quad \text{if } \zeta_g \geq 0$$

$$C_2 = 0,535 + 0,426 \kappa_{wt} - 0,029 \kappa_{wt}^2 - (0,061 + 0,074 \kappa_{wt} - 0,0085 \kappa_{wt}^2) \zeta_g, \quad \text{if } \zeta_g < 0$$

I.2 Slenderness for lateral torsional buckling

(1) The general relative slenderness parameter $\bar{\lambda}_{LT}$ for lateral-torsional buckling is given by:

$$\bar{\lambda}_{LT} = \sqrt{\frac{\alpha W_{el} f_o}{M_{cr}}} \quad (I.10)$$

where:

α is the shape factor taken from Table 6.4.

(2) Alternatively, for I-sections and channels covered by Table I.5, the value of $\bar{\lambda}_{LT}$ may be obtained from:

$$\bar{\lambda}_{LT} = \lambda_{LT} \frac{1}{\pi} \sqrt{\frac{\alpha f_o}{E}} \quad (I.11)$$

where:

$$\lambda_{LT} = \frac{XL_{cr,z} / i_z}{\left[1 + Y \left(\frac{L_{cr,z} / i_z}{h / t_2} \right)^2 \right]^{\frac{1}{4}}} \quad (I.12)$$

$L_{cr,z}$ is the buckling length for lateral torsional buckling

i_z is the minor axis radius of gyration of the gross section

h is the overall section depth

t_2 is the flange thickness ($t_2 = t$ for Case 2 and 4 in Table I.5)

X and Y are coefficients obtained from Table I.5. For lipped channel (profile 18 in Table I.8) $X = 0,95$ and $Y = 0,071$. For all Cases it is conservative to take $X = 1,0$ and $Y = 0,05$.

(3) If the flange reinforcement to an I-section or channel is not of the precise form shown in Table I.5 (simple lips), it is still permissible to obtain λ_{LT} using the above expression, providing X and Y are taken as for an equivalent simple lip having the same internal depth c , while i_z is calculated for the section with its actual reinforcement.

(4) Normally $L_{cr,z} = 1,0L$, where L is actual distance between points of lateral support to the compression flange. If at these points the both flanges of the segment ends are restrained against rotation about z-axis, the length L may be reduced by the factor 0,5 in the case of theoretical full restraints, by the factor 0,7 in the case of practically achieved full restraints and by the factor 0,85 in the case of partial restraints. Such values of the buckling lengths should be increased by the factor 1,2 if the beams with the cross-sections given in Table I.5 are under transverse destabilizing load applied at top flange level. For beam that is free to buckle over its whole length, the absence of end-post can be allowed for by further increasing $L_{cr,z}$ by an amount $2h$ above the value that would otherwise apply. Simplified procedure in I.2(2) and (3) should not be used in the case of cantilever beams if appropriate value of $L_{cr,z}$ taking into account all type of cantilever restraints and destabilizing effect of transverse loads is not known.

Table I.5 - Lateral-torsional buckling of beams, coefficients X and Y

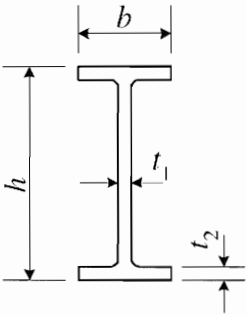
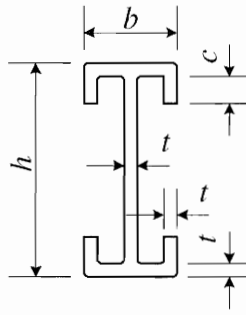
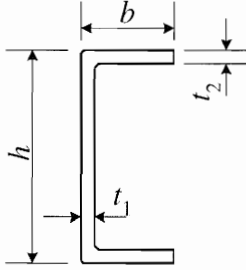
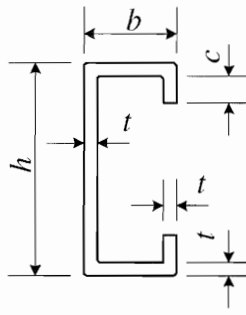
<p>1</p> 	$1,5 \leq h/b \leq 4,5$ $1 \leq t_2/t_1 \leq 2$	$X = 0,90 - 0,03h/b + 0,04t_2/t_1$ $Y = 0,05 - 0,010\sqrt{(t_2/t_1 - 1)h/b}$
<p>2</p> 	$1,5 \leq h/b \leq 4,5$ $0 \leq c/b \leq 0,5$	$X = 0,94 - (0,03 - 0,07c/b)h/b - 0,3c/b$ $Y = 0,05 - 0,06c/h$
<p>3</p> 	$1,5 \leq h/b \leq 4,5$ $1 \leq t_2/t_1 \leq 2$	$X = 0,95 - 0,03h/b + 0,06t_2/t_1$ $Y = 0,07 - 0,014\sqrt{(t_2/t_1 - 1)h/b}$
<p>4</p> 	$1,5 \leq h/b \leq 4,5$ $0 \leq c/b \leq 0,5$	$X = 1,01 - (0,03 - 0,06c/b)h/b - 0,3c/b$ $Y = 0,07 - 0,10c/h$

I.3 Elastic critical axial force for torsional and torsional-flexural buckling

(1) The elastic critical axial force N_{cr} for torsional and torsional-flexural buckling of a member of uniform cross-section, $\overline{A_1}$ under various conditions at its ends and subject to uniform axial force in the gravity centre \overline{C} is given by:

$$(N_{cr,y} - N_{cr})(N_{cr,z} - N_{cr})(N_{cr,T} - N_{cr})i_s^2 - \alpha_{zw} z_s^2 N_{cr}^2 (N_{cr,y} - N_{cr}) - \alpha_{yw} y_s^2 N_{cr}^2 (N_{cr,z} - N_{cr}) = 0 \quad (I.13)$$

where:

$$N_{cr,y} = \frac{\pi^2 EI_y}{k_y^2 L^2} \quad (I.14)$$

$$N_{cr,z} = \frac{\pi^2 EI_z}{k_z^2 L^2} \quad (I.15)$$

$$N_{cr,T} = \frac{1}{i_s^2} \left[GI_t + \frac{\pi^2 EI_w}{k_w^2 L^2} \right] \quad (I.16)$$

$\overline{A_1}$ $I_t, I_w, I_z, k_y, k_z, k_w$ and G see I.1.1. $\overline{A_1}$

L is the length of the member between points that have lateral restraint.

$$i_s^2 = \frac{I_y + I_z}{A} + y_s^2 + z_s^2 \quad (I.17)$$





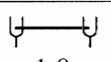
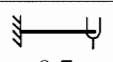
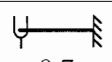
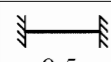
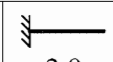
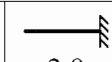
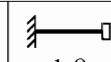
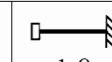
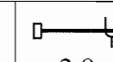
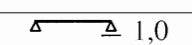
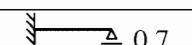
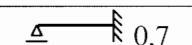
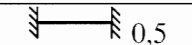
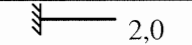
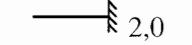
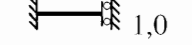
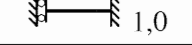
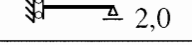

y_s and z_s are the coordinates of the shear $\overline{A_1}$ centre \overline{C} related to centroid \overline{C}
 $\alpha_{yw}(k_y, k_w)$ and $\alpha_{zw}(k_z, k_w)$ depend on the combinations of bending with torsion boundary conditions, see Table I.6, where symbols for torsion boundary conditions are explained in Table I.7

Table I.6 - Values of α_{yw} or α_{zw} for combinations of bending and torsion boundary conditions

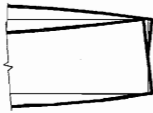
Bending boundary condition k_y or k_z	Torsion boundary condition, k_w								
	 1,0	 0,7	 0,7	 0,5	 2,0	 2,0	 1,0	 1,0	 2,0
 1,0	1	0,817	0,817	0,780	a)	a)	a)	a)	a)
 0,7	0,817	1	a)	0,766	a)	a)	a)	a)	a)
 0,7	0,817	a)	1	0,766	a)	a)	a)	a)	a)
 0,5	0,780	0,766	0,766	1	a)	a)	a)	a)	a)
 2,0	a)	a)	a)	a)	1	a)	a)	a)	a)
 2,0	a)	a)	a)	a)	a)	1	a)	a)	a)
 1,0	a)	a)	a)	a)	a)	a)	1	a)	a)
 1,0	a)	a)	a)	a)	a)	a)	a)	1	a)
 2,0	a)	a)	a)	a)	a)	a)	a)	a)	1

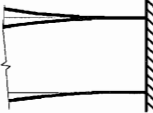
a) conservatively, use $\alpha_{yw} = 1$ and $\alpha_{zw} = 1$

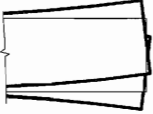
Table I.7 - Torsion boundary conditions in Table I.6

Symbol in Table I.6	Deformation of member end	Torsion boundary condition
		Rotation restrained, warping free
		Rotation restrained, warping restrained
		Rotation free, warping free
		Rotation free, warping restrained

(2) For cross-sections symmetrical about the z -axis $y_s = 0$ and the solution to equation (I.13) is:

$$N_{cr,1} = N_{cr,y} \quad (\text{flexural buckling}) \quad (\text{I.18})$$

$$N_{cr,2,3} = \frac{1}{2(1 - \alpha_{zw} z_s^2 / i_s^2)} \left[(N_{cr,z} + N_{cr,T}) \mp \sqrt{(N_{cr,z} + N_{cr,T})^2 - 4N_{cr,z} N_{cr,T} (1 - \alpha_{zw} z_s^2 / i_s^2)} \right]$$

(torsional-flexural buckling) (I.19)

(3) For doubly symmetrical cross sections $y_s = 0$ and $z_s = 0$ and the solution to equation (I.13) is:

$$N_{cr,1} = N_{cr,y}, N_{cr,2} = N_{cr,z} \quad (\text{flexural buckling}) \quad \text{and} \quad N_{cr,3} = N_{cr,T} \quad (\text{torsional buckling})$$

(4) Slenderness based on approximate formulae for certain cross sections are given in I.4(2).

I.4 Slenderness for torsional and torsional-flexural buckling

(1) The general expression for relative slenderness parameter $\bar{\lambda}_T$ for torsional and torsional-flexural buckling is:

$$\bar{\lambda}_T = \sqrt{\frac{A_{\text{eff}} f_o}{N_{cr}}} \quad (\text{I.20})$$

where

A_{eff} is the effective area for torsional or torsional-flexural buckling, see 6.3.1.2, Table 6.7

N_{cr} is the elastic critical load for torsional buckling, allowing for interaction with flexural buckling if necessary (torsional-flexural buckling). See I.3.

(2) Alternatively, for sections as given in Table I.8

$$\bar{\lambda}_T = k \lambda_t \frac{1}{\pi} \sqrt{\frac{A_{\text{eff}} f_o}{A E}} \quad (\text{I.21})$$

where k is read from Figure I.3 or given by the expression:

$$k = \sqrt{\frac{2Xs^2}{1+s^2 - \sqrt{(1+s^2)^2 - 4Xs^2}}} \quad (\text{I.22})$$

in which $X > 0$ and s are found in Table I.8.

λ_t is found as follows:

1) for angles, tees, cruciforms $\lambda_t = \lambda_0$ (I.23)

2) for channels, top-hats $\lambda_t = \frac{\lambda_0}{\sqrt{1 + Y \lambda_0^2 / \lambda_y^2}}$ (I.24)

Table I.8 contains expressions for λ_0 and Y and also for s and X (needed in expression (I.22) and for Figure I.3).

In expression (I.24) the quantity λ_y should be taken as the effective slenderness for column buckling about axis y-y (as defined in Table I.8, Cases 15 to 18).

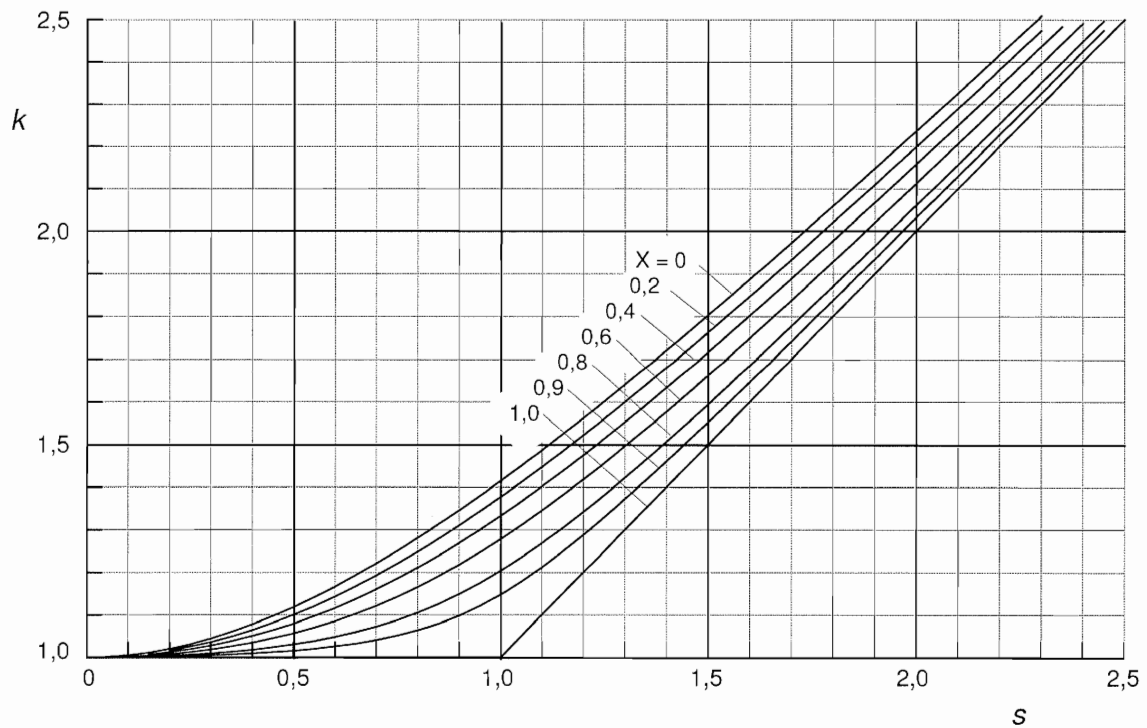

Figure I.3 - Torsional buckling of struts, interaction factor k

For the definition of s , see Table I.8

Table I.8 - Torsional buckling parameters for struts

<p>1</p> 	<p>$\rho \leq 5$ See Note 3 for ρ</p>	<p>$\lambda_0 = 5b/t - 0,6\rho^{1,5}(b/t)^{0,5}$ $s = \lambda_u / \lambda_0$ $X = 0,6$</p>
<p>2</p> 	<p>$\rho \leq 5$ $1 \leq \delta \leq 2,5$ See Note 3 for ρ</p>	<p>$\lambda_0 = 5b/t - 0,6\rho^{1,5}(b/t)^{0,5} -$ $-(\delta - 1)[2(\delta - 1)^2 - 1,5\rho]$ $s = \lambda_u / \lambda_0$ $X = 0,6$</p>
<p>3</p> 	<p>$b/t = 20$ $r_i/t = 2$ $\delta = 3$ $\beta \approx 4$ See Note 3 for r_i</p>	<p>$\lambda_0 = 66$ $s = \lambda_u / \lambda_0$ $X = 0,61$ (Equal legs)</p>
<p>4</p> 	<p>$\rho \leq 5$ $0,5 \leq b/h \leq 1$ See Note 3 for ρ</p>	<p>$\lambda_0 = \frac{h}{t} \left[4,2 + 0,8 \left(\frac{b}{h} \right)^2 \right] - 0,6\rho^{1,5} \left(\frac{h}{t} \right)^{0,5}$ $s = \left[1 + 6(1 - b/h)^2 \right] \lambda_u / \lambda_0$ $X = 0,6 - 0,4(1 - b/h)^2$</p>
<p>5</p> 	<p>$\rho \leq 5$ $0,5 \leq b/h \leq 1$ $1 \leq \delta \leq 2,5$ See Note 3 for ρ</p>	<p>$\lambda_0 = \frac{h}{t} \left[4,2 + 0,8 \left(\frac{b}{h} \right)^2 \right] - 0,6\rho^{1,5} \left(\frac{h}{t} \right)^{0,5} +$ $+ 1,5\rho(\delta - 1) - 2(\delta - 1)^3$ $s = \left[1 + 6(1 - b/h)^2 \right] \lambda_u / \lambda_0$ $X = 0,6 - 0,4(1 - b/h)^2$</p>
<p>6</p> 	<p>$h/t = 20$ $b/t = 15$ $r_i/t = 2$ $\delta = 3, \beta \approx 4$ See Note 3 for r_i</p>	<p>$\lambda_0 = 57$ $s = 1,4\lambda_u / \lambda_0$ $X = 0,6$ (Unequal legs, equal bulbs)</p>
<p>7</p> 	<p>$\rho \leq 3,5$ See Note 3 for ρ</p>	<p>$\lambda_0 = 5,1b/t - \rho^{1,5}(b/t)^{0,5}$ $X = 1$</p>

Table I.8 - Torsional buckling parameters for struts (continued)

<p>8</p> 	<p>$\rho \leq 5$ $0,5 \leq h/b \leq 2$ See Note 3 for ρ</p>	<p>$\lambda_0 = [4,4 + 1,1(b/h)^2] b/t - 0,7\rho^{1,5} (b/t)^{0,5}$ $s = \lambda_z / \lambda_0$ $X = 1,1 - 0,3h/b$</p>
<p>9</p> 	<p>$\rho \leq 5$ $0,5 \leq h/b \leq 2$ $1 \leq \delta \leq 2,5$ See Note 3 for ρ</p>	<p>$\lambda_0 = [4,4 + 1,1(b/h)^2] b/t - 0,7\rho^{1,5} (b/t)^{0,5} + 1,5\rho(\delta - 1) - 2(\delta - 1)^3$ $s = \lambda_z / \lambda_0$ $X = 1,1 - 0,3h/b$</p>
<p>10</p> 	<p>Shape of angles as Case 3.</p>	<p>$\lambda_0 = 70$ $s = \lambda_z / \lambda_0$ $X = 0,83$</p>
<p>11</p> 	<p>Shape of angles as Case 6.</p>	<p>$\lambda_0 = 60$ $s = \lambda_z / \lambda_0$ $X = 0,76$</p>
<p>12</p> 	<p>Shape of angles as Case 6.</p>	<p>$\lambda_0 = 63$ $s = \lambda_z / \lambda_0$ $X = 0,89$</p>
<p>13</p> 	<p>$\rho \leq 3,5$ $0,5 \leq h/b \leq 2$ See Note 3 for ρ</p>	<p>$\lambda_0 = (1,4 + 1,5b/h + 1,1h/b) h/t - \rho^{1,5} (h/t)^{0,5}$ $s = \lambda_z / \lambda_0$ $X = 1,3 - 0,8h/b + 0,2(h/b)^2$</p>
<p>14</p> 	<p>$h/t = 25$ $b/h = 1,2$ $r_i/t = 0,5$ See Note 3 for r_i</p>	<p>$\lambda_0 = 65$ $s = \lambda_z / \lambda_0$ $X = 0,78$</p>

Table I.8 - Torsional buckling parameters for struts (continued)

<p>15</p> 	<p>$1 \leq h/b \leq 3$ $1 \leq t_2/t_1 \leq 2$</p>	<p>$\lambda_0 = (b/t_2)(7 + 1,5(h/b)t_2/t_1)$ $s = \lambda_y / \lambda_t$ $X = 0,38h/b - 0,04(h/b)^2$ $Y = 0,14 - 0,02h/b - 0,02t_2/t_1$</p>
<p>16</p> 	<p>$1 \leq h/b \leq 3$ $c/b \leq 0,4$</p>	<p>$\lambda_0 = (b/t)(7 + 1,5h/b + 5c/b)$ $s = \lambda_y / \lambda_t$ $X = 0,38h/b - 0,04(h/b)^2 - 0,25c/b$ $Y = 0,12 - 0,02h/b + \frac{0,6(c/b)^2}{h/b - 0,5}$</p>
<p>17</p> 	<p>$1 \leq h/b \leq 3$ $c/b \leq 0,4$</p>	<p>$\lambda_0 = (b/t)(7 + 1,5h/b + 5c/b)$ $s = \lambda_y / \lambda_t$ $X = 0,38h/b - 0,04(h/b)^2$ $Y = 0,12 - 0,02h/b - \frac{0,05c/b}{h/b - 0,5}$</p>
<p>18</p> 	<p>$h/t = 32$ $b/h = 0,5$ $r_i/t = 2$ See Note 3 for r_i</p>	<p>$\lambda_0 = 126$ $s = \lambda_y / \lambda_t$ $X = 0,59$ $Y = 0,104$</p>

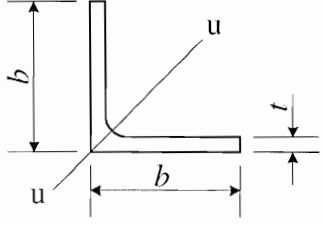
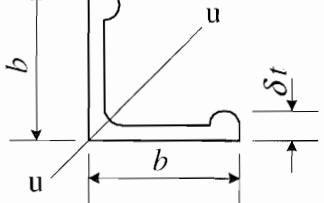
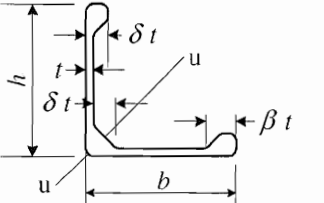
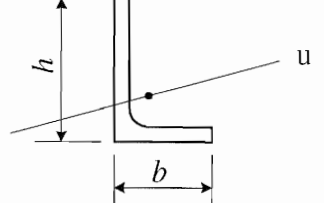
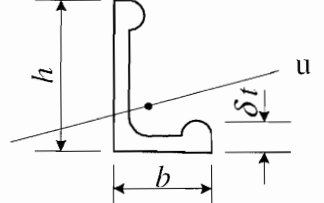
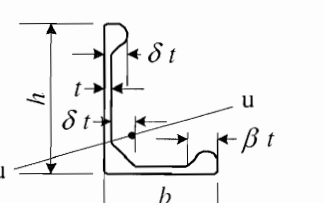
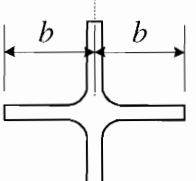
- 1) The sections are generally of uniform thickness t , except Cases 14 and 15
- 2) λ_u, λ_y or λ_z is the slenderness for flexural buckling about u, y or z axis
- 3) ρ is a factor depending on the amount of material at the root of the section as follows:

radiused fillet $\rho = r/t$

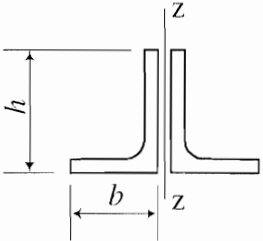
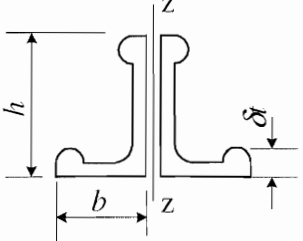
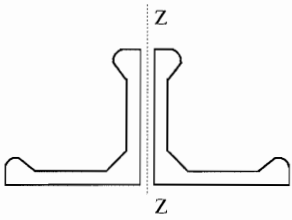
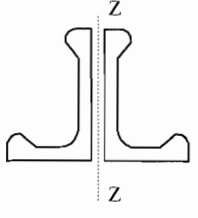
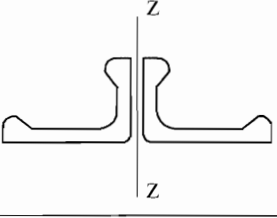
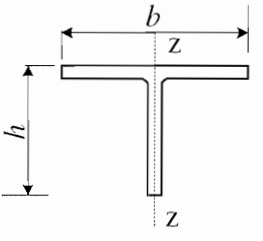
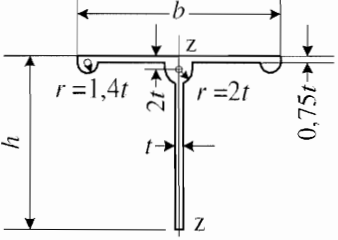
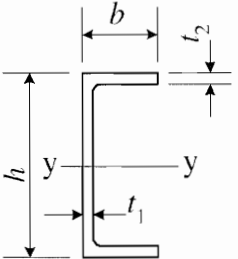
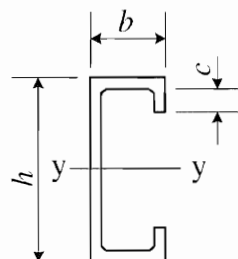
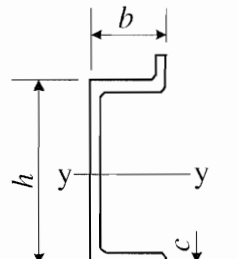
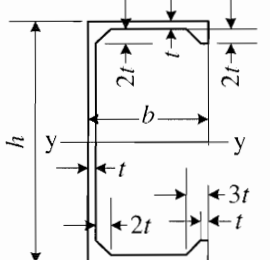
45° fillets $\rho = 1,6z/t$

r_i is inner radius

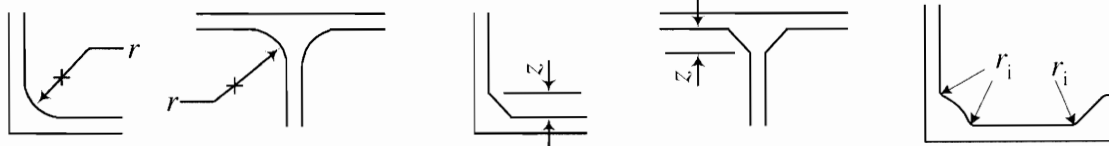

- 4) The values given for λ_0, X and Y are only valid within the limits shown. In the case of back-to-back angles (Cases 8 to 12) the expressions ceases to apply if the gap between the angles exceeds $2t$.

Annex J [informative] - Properties of cross sections

J.1 Torsion constant I_t

(1) For an open thin-walled section composed solely of flat plate parts, each of uniform thickness, and reinforced with fillets and/or bulbs, the value of the torsion constant I_t is given by

$$I_t = \sum b_{sh} t^3 / 3 - 0,105 \sum t^4 + \sum (\beta + \delta \gamma)^4 t^4 \quad (J.1)$$

in which the first sum concerns flat plates, second term is applied to free ends of flat plates without bulbs only and last sum concerns fillets or bulbs and:

t = thickness of flat cross-section parts

β , δ and γ are fillet or bulb factors, see Figure J.1, Case 3 to 11

b_{sh} = width of flat cross-section parts, measured to the edge of the shaded area in Figure J.1 in the case of a flat cross-section part abutting a fillet or bulb.

(2) For Case 1 and 2 in Figure J.1, with different thickness t_1 and t_2

$$I_t = \sum b t^3 / 3 - 0,105 \sum t^4 + \sum \alpha D^4 \quad (J.1a)$$

in which α and δ are fillet factors and D is diameter of inscribed circle, see Figure J.1.

(3) For a simple rectangular cross-section with any b/t ratio ≥ 1

$$I_t = \frac{b t^3}{3} \left(1 - 0,63 \frac{t}{b} + 0,052 \frac{t^5}{b^5} \right) \quad (J.2)$$

(4) For closed cross sections I_t is found in J.6.

J.2 Position of shear centre S

(1) Figure J.2 gives the position of the shear centre for a number of cross-sections. See J.4 and J.5 for open thin-walled cross sections and J.6 for mono-symmetrical closed cross sections.

J.3 Warping constant I_w

(1) Values of the warping constant I_w for certain types of cross-section may be found as follows:

a) for sections composed entirely of radiating outstands e.g. angles, tees, cruciforms, I_w may conservatively be taken as zero or

$$I_w = \sum b^3 t^3 / 36 \quad (J.3)$$

where b is the width and t is thickness of outstand cross-section parts, see L-section and T-section in Figure J.2.

b) For simple rectangular cross-section with any b/t ratio ≥ 1

$$I_w = \frac{b^3 t^3}{144} \left(1 - 4,884 \frac{t^2}{b^2} + 4,97 \frac{t^3}{b^3} - 1,067 \frac{t^5}{b^5} \right) \quad (J.4)$$

c) for the specific types of section illustrated in Figure J.2 values of I_w may be calculated using the expression given there.

d) formulae for section constants, including shear \bar{A}_1 centre \bar{A}_1 position and warping constant I_w , for open thin-walled cross sections are given in J.4 and J.5.

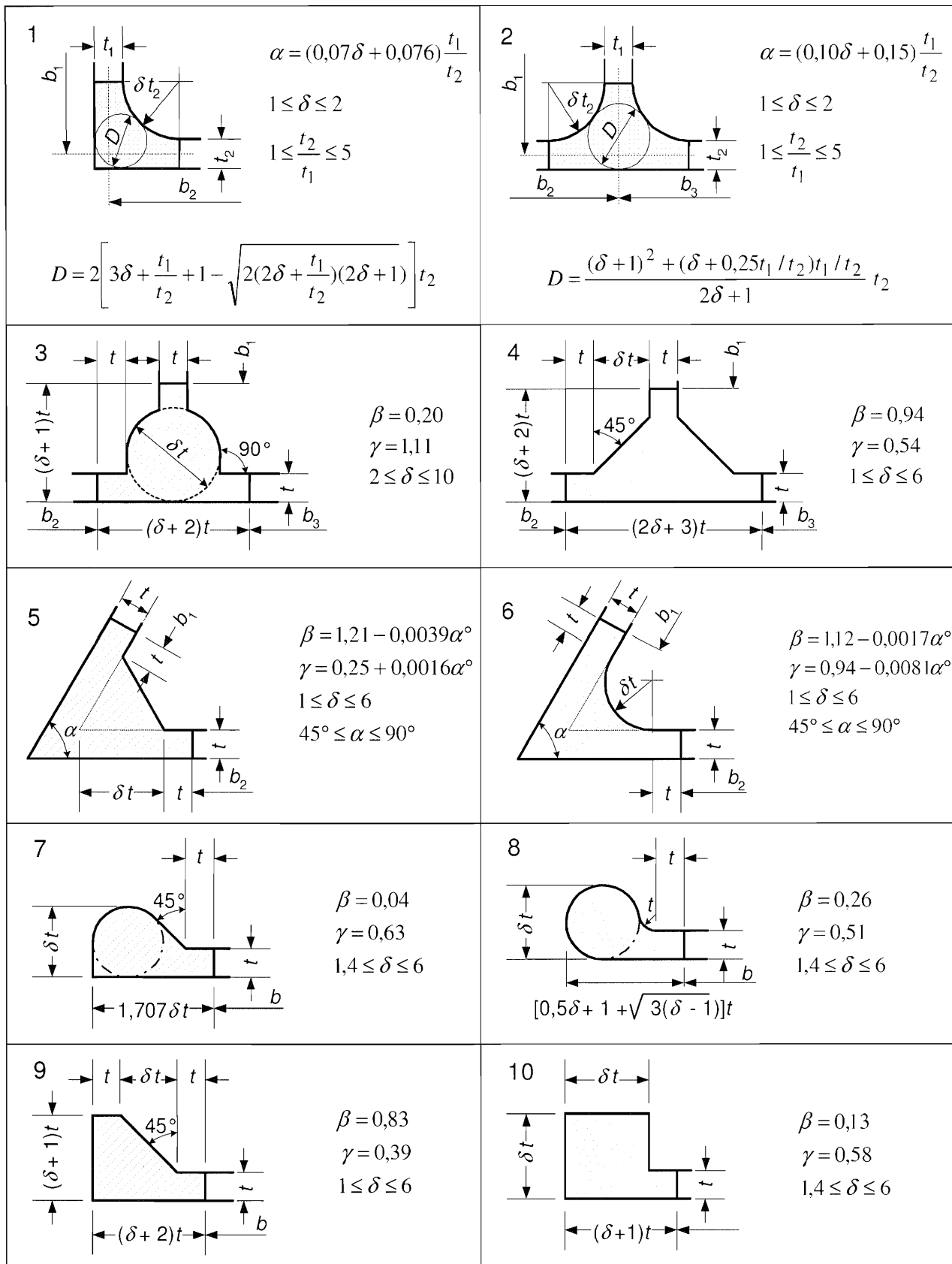

Figure J.1 - Torsion constant factors for certain fillets and bulbs

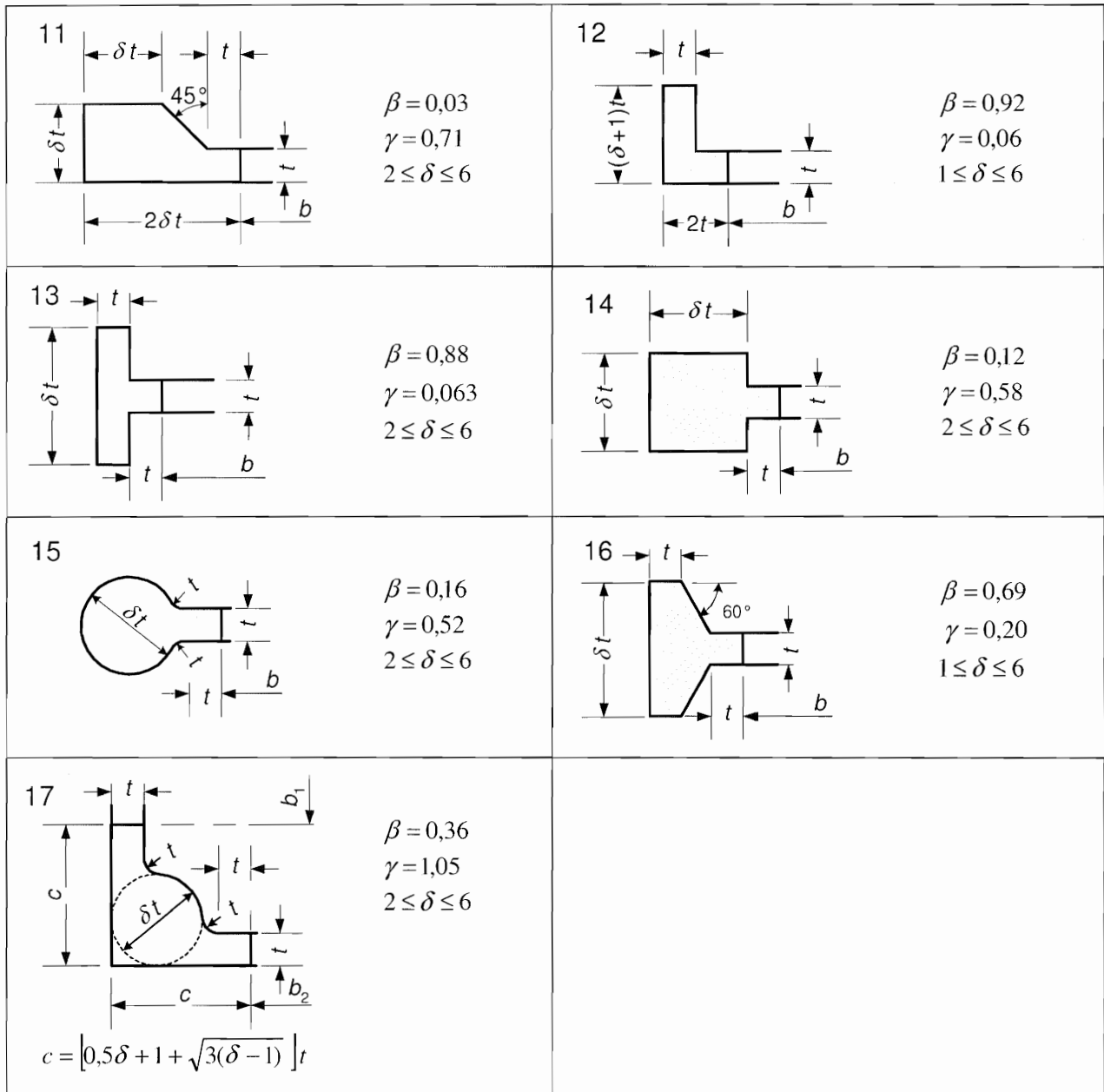

Figure J.1 - Torsion constant factors for certain fillets and bulbs (continued)

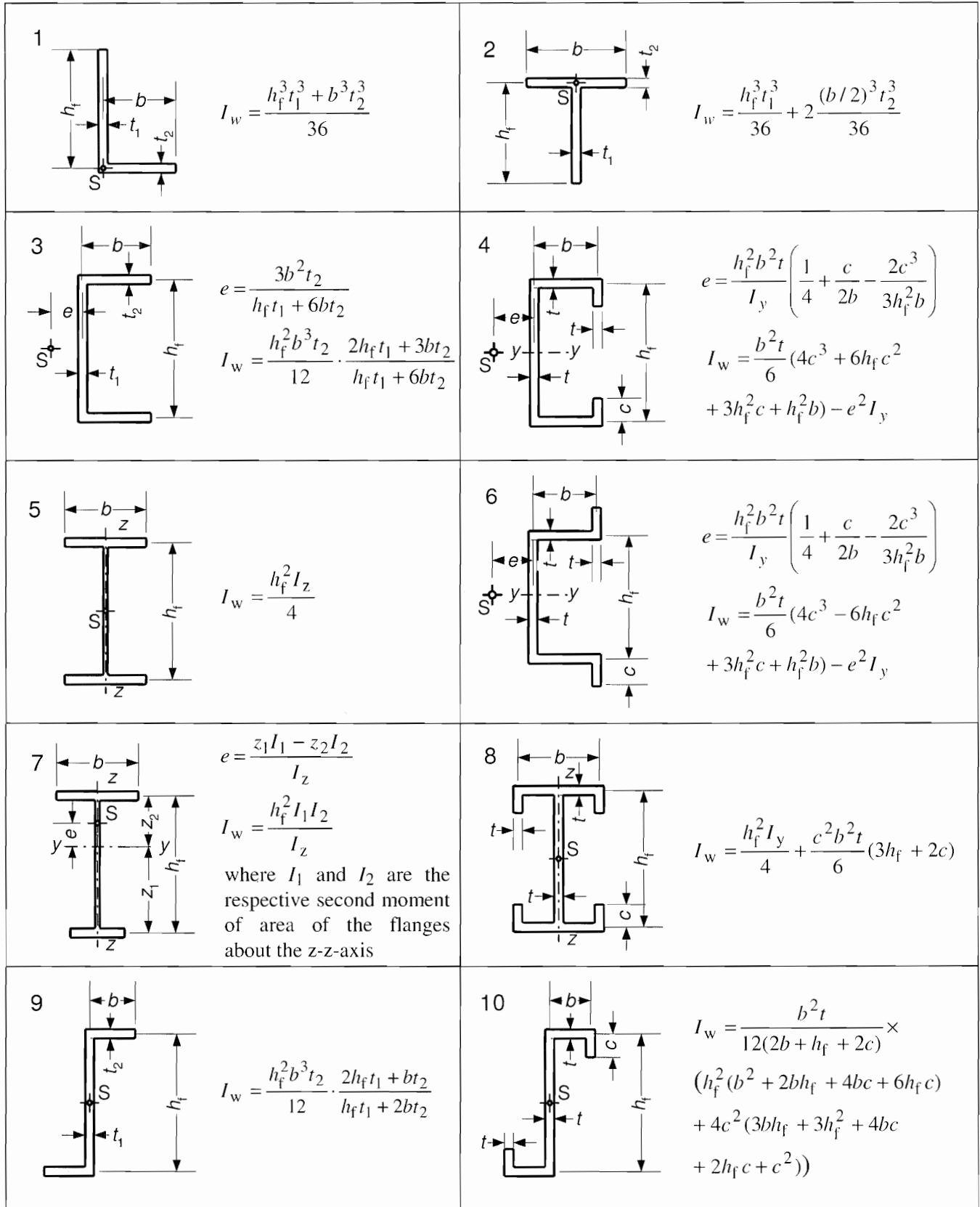

Figure J.2 - Shear-centre position S and warping constant I_w for certain thin-walled sections

J.4 Cross section constants for open thin-walled cross sections

(1) Divide the cross section into n parts. Number the parts 1 to n .
Insert nodes between the parts. Number the nodes 0 to n .
Part i is then defined by nodes $i - 1$ and i .
Give nodes, co-ordinates and (effective) thickness.

Nodes and parts $j = 0..n \quad i = 1..n$

Area of cross section parts

$$dA_i = \left[t_i \cdot \sqrt{(y_i - y_{i-1})^2 + (z_i - z_{i-1})^2} \right] \quad (J.5)$$

Cross section area

$$A = \sum_{i=1}^n dA_i \quad (J.6)$$

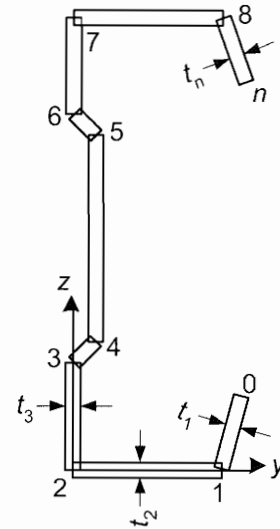

Figure J.3 - Cross section nodes

First moment of area with respect to y -axis and coordinate for gravity centre

$$S_{y0} = \sum_{i=1}^n (z_i + z_{i-1}) \cdot \frac{dA_i}{2} \quad z_{gc} = \frac{S_{y0}}{A} \quad (J.7)$$

Second moment of area with respect to original y -axis and new y -axis through gravity centre

$$I_{y0} = \sum_{i=1}^n \left[(z_i)^2 + (z_{i-1})^2 + z_i \cdot z_{i-1} \right] \cdot \frac{dA_i}{3} \quad I_y = I_{y0} - A \cdot z_{gc}^2 \quad (J.8)$$

First moment of area with respect to z -axis and gravity centre

$$S_{z0} = \sum_{i=1}^n (y_i + y_{i-1}) \cdot \frac{dA_i}{2} \quad y_{gc} = \frac{S_{z0}}{A} \quad (J.9)$$

Second moment of area with respect to original z -axis and new z -axis through gravity centre

$$I_{z0} = \sum_{i=1}^n \left[(y_i)^2 + (y_{i-1})^2 + y_i \cdot y_{i-1} \right] \cdot \frac{dA_i}{3} \quad I_z = I_{z0} - A \cdot y_{gc}^2 \quad (J.10)$$

Product moment of area with respect of original y - and z -axis and new axes through gravity centre

$$I_{yz0} = \sum_{i=1}^n (2 \cdot y_{i-1} \cdot z_{i-1} + 2 \cdot y_i \cdot z_i + y_{i-1} \cdot z_i + y_i \cdot z_{i-1}) \cdot \frac{dA_i}{6} \quad I_{yz} = I_{yz0} - \frac{S_{y0} \cdot S_{z0}}{A} \quad (J.11)$$

Principal axis

$$\alpha = \frac{1}{2} \arctan \left(\frac{2I_{yz}}{I_z - I_y} \right) \text{ if } (I_z - I_y) \neq 0 \text{ otherwise } \alpha = 0 \quad (J.12)$$

$$I_\xi = \frac{1}{2} \cdot \left[I_y + I_z + \sqrt{(I_z - I_y)^2 + 4 \cdot I_{yz}^2} \right] \quad (J.13)$$

$$I_\eta = \frac{1}{2} \cdot \left[I_y + I_z - \sqrt{(I_z - I_y)^2 + 4 \cdot I_{yz}^2} \right] \quad (J.14)$$

Sectorial co-ordinates

$$\omega_0 = 0 \quad \omega_{0_i} = y_{i-1} \cdot z_i - y_i \cdot z_{i-1} \quad \omega_i = \omega_{i-1} + \omega_{0_i} \quad (J.15)$$

Mean of sectorial coordinate

$$I_{\omega} = \sum_{i=1}^n (\omega_{i-1} + \omega_i) \cdot \frac{dA_i}{2} \quad \omega_{mean} = \frac{I_{\omega}}{A} \quad (J.16)$$

Sectorial constants

$$I_{y\omega} = \sum_{i=1}^n (2 \cdot y_{i-1} \cdot \omega_{i-1} + 2 \cdot y_i \cdot \omega_i + y_{i-1} \cdot \omega_i + y_i \cdot \omega_{i-1}) \cdot \frac{dA_i}{6} \quad I_{y\omega} = I_{y\omega} - \frac{S_{z0} \cdot I_{\omega}}{A} \quad (J.17)$$

$$I_{z\omega} = \sum_{i=1}^n (2 \cdot \omega_{i-1} \cdot z_{i-1} + 2 \cdot \omega_i \cdot z_i + \omega_{i-1} \cdot z_i + \omega_i \cdot z_{i-1}) \cdot \frac{dA_i}{6} \quad I_{z\omega} = I_{z\omega} - \frac{S_{y0} \cdot I_{\omega}}{A} \quad (J.18)$$

$$I_{\omega\omega} = \sum_{i=1}^n \left[(\omega_i)^2 + (\omega_{i-1})^2 + \omega_i \cdot \omega_{i-1} \right] \cdot \frac{dA_i}{3} \quad I_{\omega\omega} = I_{\omega\omega} - \frac{I_{\omega}^2}{A} \quad (J.19)$$

Shear centre

$$y_{sc} = \frac{I_{z\omega} I_z - I_{y\omega} I_{yz}}{I_y I_z - I_{yz}^2} \quad z_{sc} = \frac{-I_{y\omega} I_y + I_{z\omega} I_{yz}}{I_y I_z - I_{yz}^2} \quad (I_y I_z - I_{yz}^2 \neq 0) \quad (J.20)$$

Warping constant

$$I_w = I_{\omega\omega} + z_{sc} \cdot I_{y\omega} - y_{sc} \cdot I_{z\omega} \quad (J.21)$$

Torsion constants

$$I_t = \sum_{i=1}^n dA_i \cdot \frac{(t_i)^2}{3} \quad W_t = \frac{I_t}{\min(t)} \quad (J.22)$$

Sectorial co-ordinate with respect to shear centre

$$\omega_{s_j} = \omega_j - \omega_{mean} + z_{sc} \cdot (y_j - y_{gc}) - y_{sc} \cdot (z_j - z_{gc}) \quad (J.23)$$

Maximum sectorial co-ordinate and warping modulus

$$\omega_{max} = \max(|\omega_s|) \quad W_w = \frac{I_w}{\omega_{max}} \quad (J.24)$$

Distance between shear centre and gravity centre

$$y_s = y_{sc} - y_{gc} \quad z_s = z_{sc} - z_{gc} \quad (J.25)$$

Polar moment of area with respect to shear centre

$$I_p := I_y + I_z + A(y_s^2 + z_s^2) \quad (J.26)$$

Non-symmetry factors z_j and y_j according to Annex I

$$z_j = z_s - \frac{0.5}{I_y} \cdot \sum_{i=1}^n \left[(z_{c_i})^3 + z_{c_i} \cdot \left[\frac{(z_i - z_{i-1})^2}{4} + (y_{c_i})^2 + \frac{(y_i - y_{i-1})^2}{12} \right] + y_{c_i} \cdot \frac{(y_i - y_{i-1}) \cdot (z_i - z_{i-1})}{6} \right] \cdot dA_i \quad (J.27)$$

$$y_j = y_s - \frac{0.5}{I_z} \cdot \sum_{i=1}^n \left[(y_{c_i})^3 + y_{c_i} \cdot \left[\frac{(y_i - y_{i-1})^2}{4} + (z_{c_i})^2 + \frac{(z_i - z_{i-1})^2}{12} \right] + z_{c_i} \cdot \frac{(z_i - z_{i-1}) \cdot (y_i - y_{i-1})}{6} \right] \cdot dA_i \quad (J.28)$$

where the coordinates for the centre of the cross section parts with respect to shear A_1 centre A_1 are

$$y_{c_i} = \frac{y_i + y_{i-1}}{2} - y_{gc} \quad z_{c_i} = \frac{z_i + z_{i-1}}{2} - z_{gc} \quad (J.29)$$

NOTE $z_j = 0$ ($y_j = 0$) for cross sections with y-axis (z-axis) being axis of symmetry, see Figure J.3.

J.5 Cross section constants for open cross section with branches

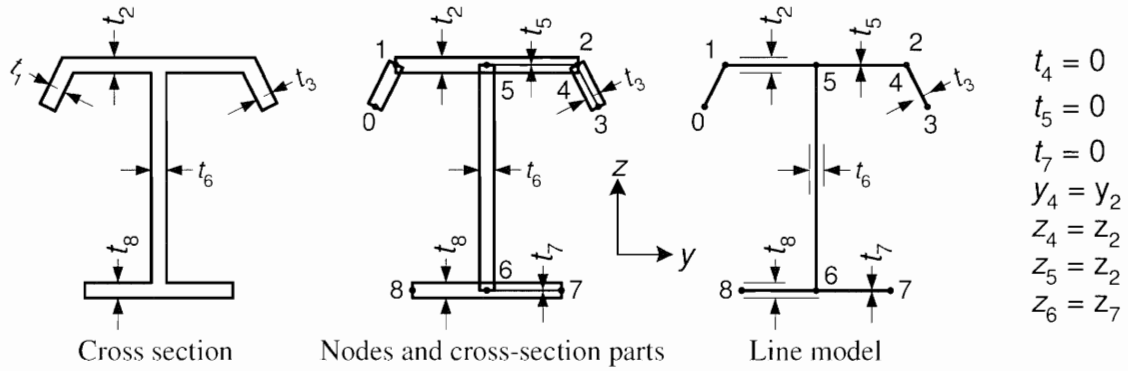

Figure J.4 - Nodes and parts in a cross section with branches

(1) In cross sections with branches, formulae in J.4 can be used. However, follow the branching back (with thickness $t = 0$) to the next part with thickness $t \neq 0$, see branch 3 - 4 - 5 and 6 - 7 in Figure J.4.

J.6 Torsion constant and shear A_1 centre \bar{A}_1 of cross section with closed part

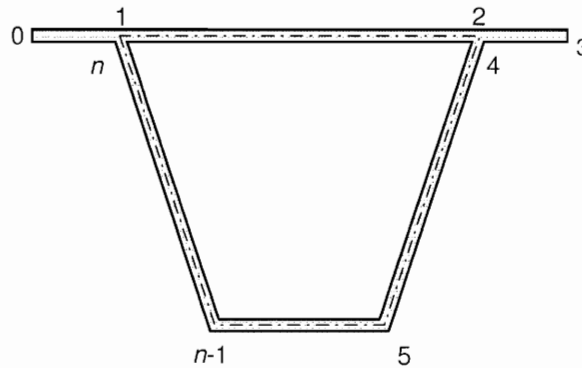

Figure J.5 - Cross section with closed part

(1) For a symmetric or non-symmetric cross section with a closed part, Figure J.5, the torsion constant is given by

$$I_t = \frac{4A_t^2}{S_t} \quad \text{and} \quad W_t = 2 A_t \min(t_i) \tag{J.30}$$

where

$$A_t = 0,5 \sum_{i=2}^n (y_i - y_{i-1})(z_i + z_{i-1}) \tag{J.31}$$

$$S_t = \sum_{i=2}^n \frac{\sqrt{(y_i - y_{i-1})^2 + (z_i - z_{i-1})^2}}{t_i} \quad (t_i \neq 0) \tag{J.32}$$

Annex K [informative] - Shear lag effects in member design

K.1 General

(1) Shear lag in flanges may be neglected provided that $b_0 < L_e / 50$ where the flange width b_0 is taken as the outstand or half the width of an internal cross section part and L_e is the length between points of zero bending moment, see K.2.1(2).

NOTE The National Annex may give rules where shear lag in flanges may be neglected at ultimate limit states. $b_0 < L_e / 25$ is recommended for support regions, cantilevers and region with concentrated load. For sagging bending regions $b_0 < L_e / 15$ is recommended.

(2) Where the above limit is exceeded the effect of shear lag in flanges should be considered at serviceability and fatigue limit state verifications by the use of an effective width according to K.2.1 and a stress distribution according to K.2.2. For effective width at the ultimate limit states, see K.3.

(3) Stresses under elastic conditions from the introduction of in-plane local loads into the web through flange should be determined from K.2.3.

K.2 Effective width for elastic shear lag

K.2.1 Effective width factor for shear lag

(1) The effective width b_{eff} for shear lag under elastic condition should be determined from:

$$b_{\text{eff}} = \beta_s b_0 \quad (\text{K.1})$$

where the effective factor β_s is given in Table K.1.

NOTE This effective width may be relevant for serviceability limit states.

(2) Provided adjacent internal spans do not differ more than 50% and cantilever span is not larger than half the adjacent span the effective length L_e may be determined from Figure K.1. In other cases L_e should be taken as distance between adjacent points of zero bending moment.

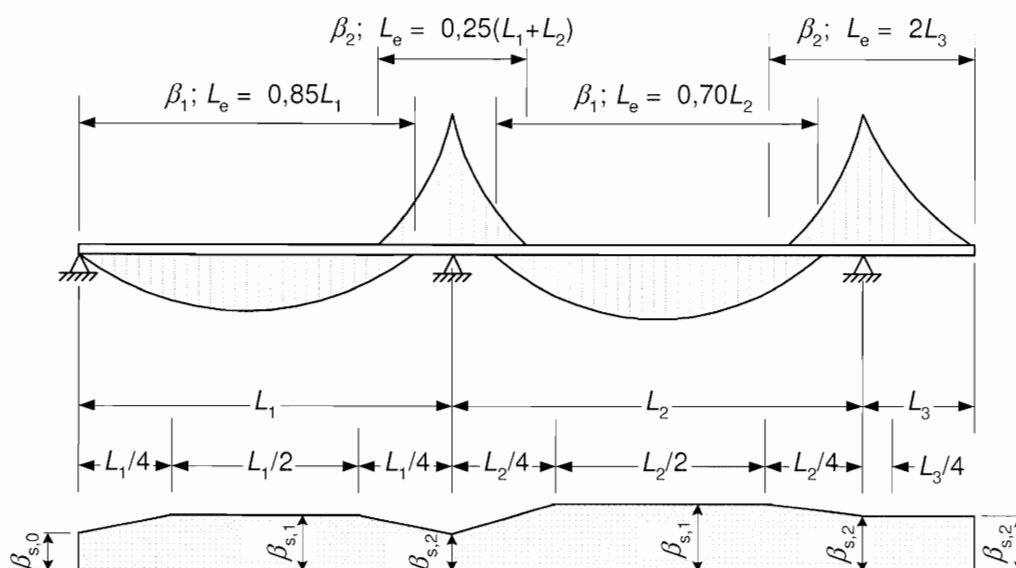
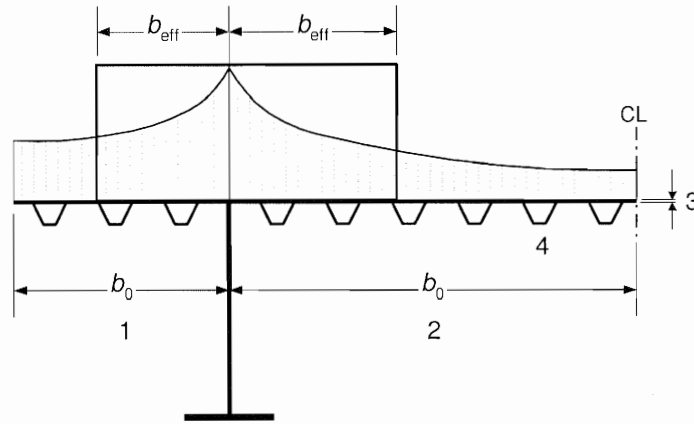

Figure K.1 - Effective length L_e for continuous beam and distribution of effective width



1 for outstand flange, 2 for internal flange, 3 plate thickness t , 4 stiffeners with $A_{st} = \sum A_{st,i}$

Figure K.2 - Definitions of notations for shear lag

Table K.1 - Effective width factor β_s

κ	Location for verification	β_s
$\kappa \leq 0,02$		$\beta_s = 1,0$
$0,02 < \kappa \leq 0,70$	sagging bending	$\beta_s = \beta_{s,1} = \frac{1}{1 + 6,4\kappa^2}$
	hogging bending	$\beta_s = \beta_{s,2} = \frac{1}{1 + 6,0(\kappa - 0,0004 / \kappa) + 1,6\kappa^2}$
$\kappa > 0,70$	sagging bending	$\beta_s = \beta_{s,1} = \frac{1}{5,9\kappa}$
	hogging bending	$\beta_s = \beta_{s,2} = \frac{1}{8,6\kappa}$
All κ	end support	$\beta_{s,0} = (0,55 + 0,025 / \kappa)\beta_{s,1}$ but $\beta_{s,0} \leq \beta_{s,1}$
All κ	cantilever	$\beta_s = \beta_{s,2}$ at support and at the end
$\kappa = \alpha_0 b_0 / L_c$ with $\alpha_0 = \sqrt{1 + A_{st} / (b_0 t)}$ in which A_{st} is the area of all longitudinal stiffeners within the width b_0 and other symbols as defined in Figure K.1 and Figure K.2.		

K.2.2 Stress distribution for shear lag

(1) The distribution of longitudinal stresses across the plate due to shear lag should be obtained from Figure K.3.

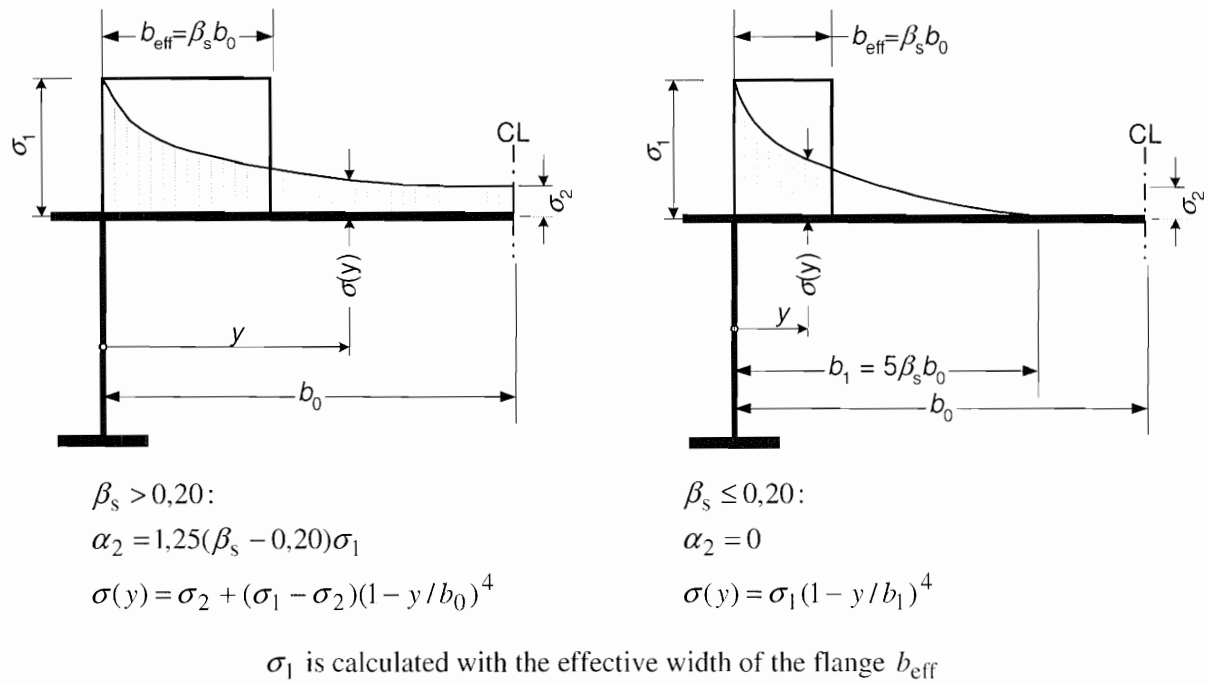

Figure K.3 - Distribution of longitudinal stresses across the plate due to shear lag

K.2.3 In-plane load effects

(1) The elastic stress distribution in a stiffened or unstiffened plate due to the local introduction of in-plane forces (see Figure K.4) should be determined from:

$$\sigma_1 = \frac{F_{\text{Ed}}}{b_{\text{eff}}(t + a_{\text{st},1})} \quad (\text{K.2})$$

with: $b_{\text{eff}} = s_e \sqrt{1 + \left(\frac{z}{s_e n}\right)^2}$

$$n = 0,636 \sqrt{1 + \frac{0,878 a_{\text{st},1}}{t}}$$

$$s_e = s_s + 2t_f$$

where $a_{\text{st},1}$ is the gross-sectional area of the smeared stiffeners per unit length, i.e. the area of the stiffener divided by the centre-to-centre distance.

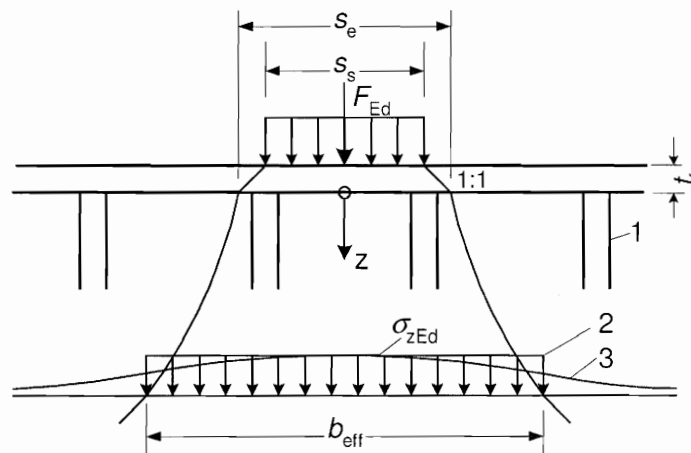

1 stiffener, 2 simplified stress distribution, 3 actual stress distribution.

Figure K.4 - In-plane load introduction

NOTE The stress distribution may be relevant for the fatigue verification.

K.3 Shear lag at ultimate limit states

(1) At ultimate limit states shear lag effects may be determined using one of the following methods:

- a) elastic shear lag effects as defined for serviceability and fatigue limit states;
- b) interaction of shear lag effects with geometric effects of plate buckling;
- c) elastic-plastic shear lag effects allowing for limited plastic strains.

NOTE 1 The National Annex may choose the method to be applied. Method a) is recommended.

NOTE 2 The geometric effects of plate buckling on shear lag may be taken into account by first reducing the flange width to an effective width as defined for the serviceability limit states, then reducing the thickness to an effective thickness for local buckling basing the slenderness β on the effective width for shear lag.

NOTE 3 The National Annex may give rules for elastic-plastic shear lag effects allowing for limited plastic strains.

Annex L [informative] - Classification of joints

L.1 General

(1) The following definitions apply:

Connection: Location at which two members are interconnected and assembly of connection elements and - in case of a major axis joint - the load introduction into the column web panel.

Joint: Assembly of basic components that enables members to be connected together in such a way that the relevant internal forces and moment can be transferred between them. A beam-to-column joint consists of a web panel and either one connection (single sided joint configuration) or two connections (double sided joint configuration).

A "Connection" is defined as the system, which mechanically fastens a given member to the remaining part of the structure. It should be distinguished from the term "joint", which usually means the system composed by the connection itself plus the corresponding interaction zone between the connected members (see Figure L.1).

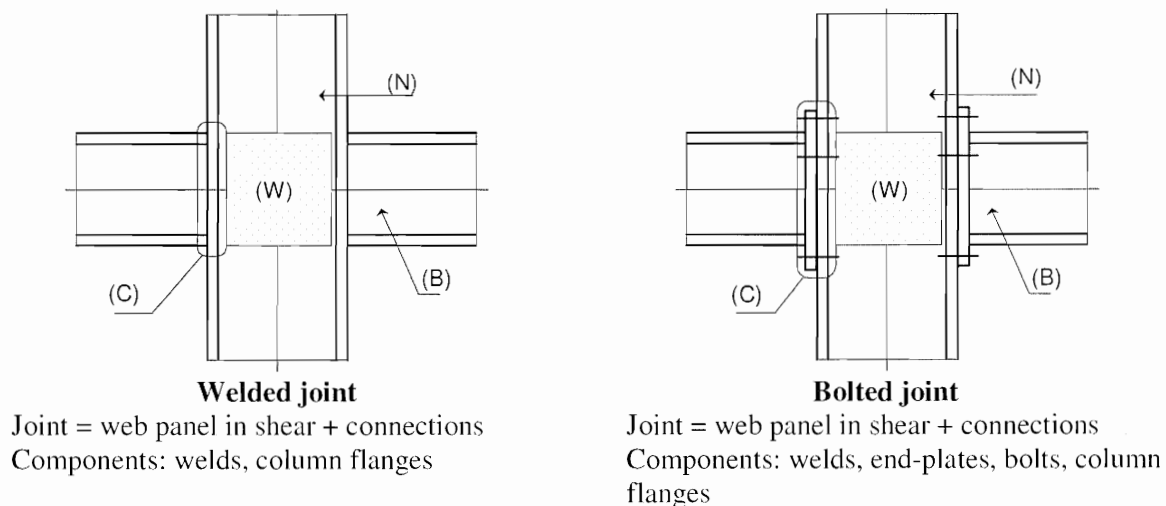

Figure L.1 - Definition of "connection" and "joint"

(2) Structural properties (of a joint): Its resistance to internal forces and moments in the connected members, its rotational stiffness and its rotation capacity.

(3) In the following the symbols " F " and " V " refer to a generalized force (axial load, shear load or bending moment) and to the corresponding generalized deformation (elongation, distortion or rotation), respectively. The subscripts "e" and "u" refer to the elastic and ultimate limit state, respectively.

(4) Connections may be classified according to their capability to restore the behavioural properties (rigidity, strength and ductility) of the connected member. With respect to the global behaviour of the connected member, two main classes are defined (Figure. L.2):

- fully restoring connections;
- partially restoring connection.

(5) With respect to the single behavioural property of the connected member, connections may be classified according to (Figures L.2.b-d):

- rigidity;
- strength;
- ductility.

(6) The types of connection should conform with the member design assumptions and the method of global analysis.

L.2 Fully restoring connections

(1) Fully restoring connections are designed to have properties at least equal to those of the connecting members in terms of ultimate strength, elastic rigidity and ductility. The generalized force-displacement curve of the connection lies above those of the connected members.

(2) The existence of the connection may be ignored in the structural analysis.

L.3 Partially restoring connections

(1) The behavioural properties of the connection do not reach those of the connected member, due to its lack of capability to restore either elastic rigidity, ultimate strength or ductility of the connected member. The generalized force-displacement curve may in some part fall below the one of the connected member.

(2) The existence of such connections must be considered in the structural analysis.

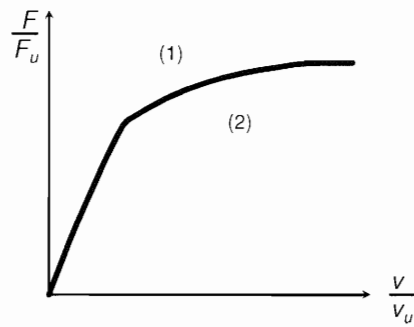

- (1) Fully restoring region
 (2) Partially restoring region

a) Classification according to member global properties restoration

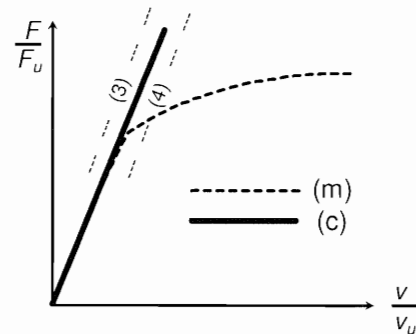

- (3) Rigidity restoring (rigid)
 (4) Rigidity non-restoring (semi-rigid)

b) Classification according to rigidity

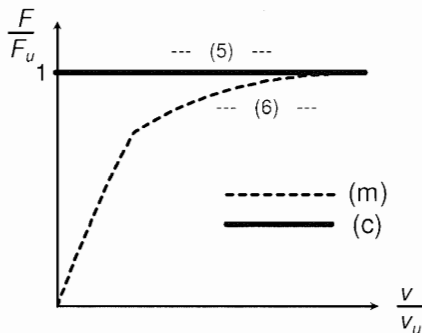

- (5) Strength restoring (full strength)
 (6) Strength non-restoring (partially strength)

c) Classification according to strength

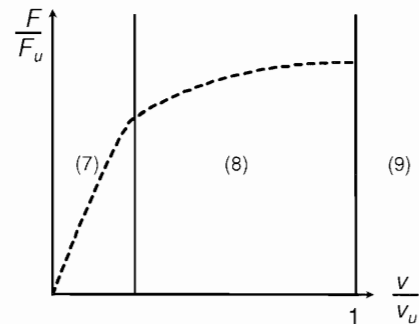

- (7) Ductility non-restoring (brittle)
 (8) Ductility non-restoring (semi ductile)
 (9) Ductility restoring (ductile)

d) Classification according to ductility

(m) Connected member, (c) Limit of connection behaviour

Figure L.2.a) - d) - Classification of connections

L.4 Classification according to rigidity

(1) With respect to rigidity, joints should be classified as (Figure L.2.b):

- rigidity restoring (rigid) joints (R1);
- rigidity non-restoring joints (semi-rigid) joints (R2),

depending on whether the initial stiffness of the jointed member is restored or not, regardless of strength and ductility.

L.5 Classification according to strength

(1) With respect to strength, connections can be classified as (Figure L.2.c):

- strength restoring (full strength) connections;
- strength non-restoring connections (partial strength) connections,

depending on whether the ultimate strength of the connected member is restored or not, regardless of rigidity and ductility.

L.6 Classification according to ductility

(1) With respect to ductility, connections can be classified as (Figure L.2.d):

- ductility restoring (ductile) connections;
- ductility non-restoring (semi-ductile or brittle) connections,

depending on whether the ductility of the connection is higher or lower than that of the connected member, regardless of strength and rigidity.

(2) Ductile connections have a ductility equal or higher than that of the connected member; elongation or rotation limitations may be ignored in structural analysis.

(3) Semi-ductile connections have a ductility less than the one of the connected member, but higher than its elastic limit deformation; elongation or rotation limitations must be considered in inelastic analysis.

(4) Brittle connections have a ductility less than the elastic limit deformation of the connected member; elongation or rotation limitations must be considered in both elastic and inelastic analysis.

L.7 General design requirements for connections

(1) The relevant combinations of the main behavioural properties (rigidity, strength and ductility) of connections give rise to several cases (Figure L.3).

In Table L.1 they are shown with reference to the corresponding requirements for methods of global analysis (see 5.2.1).

L.8 Requirements for framing connections

L.8.1 General

(1) With respect to the moment-curvature relationship, the connection types adopted in frame structures can be divided into:

- nominally pinned connections;
- built-in connections.

(2) The types of connections should conform with Table L.1 in accordance with the method of global analysis (see 5.2.1) and the member design assumptions (Annex F).

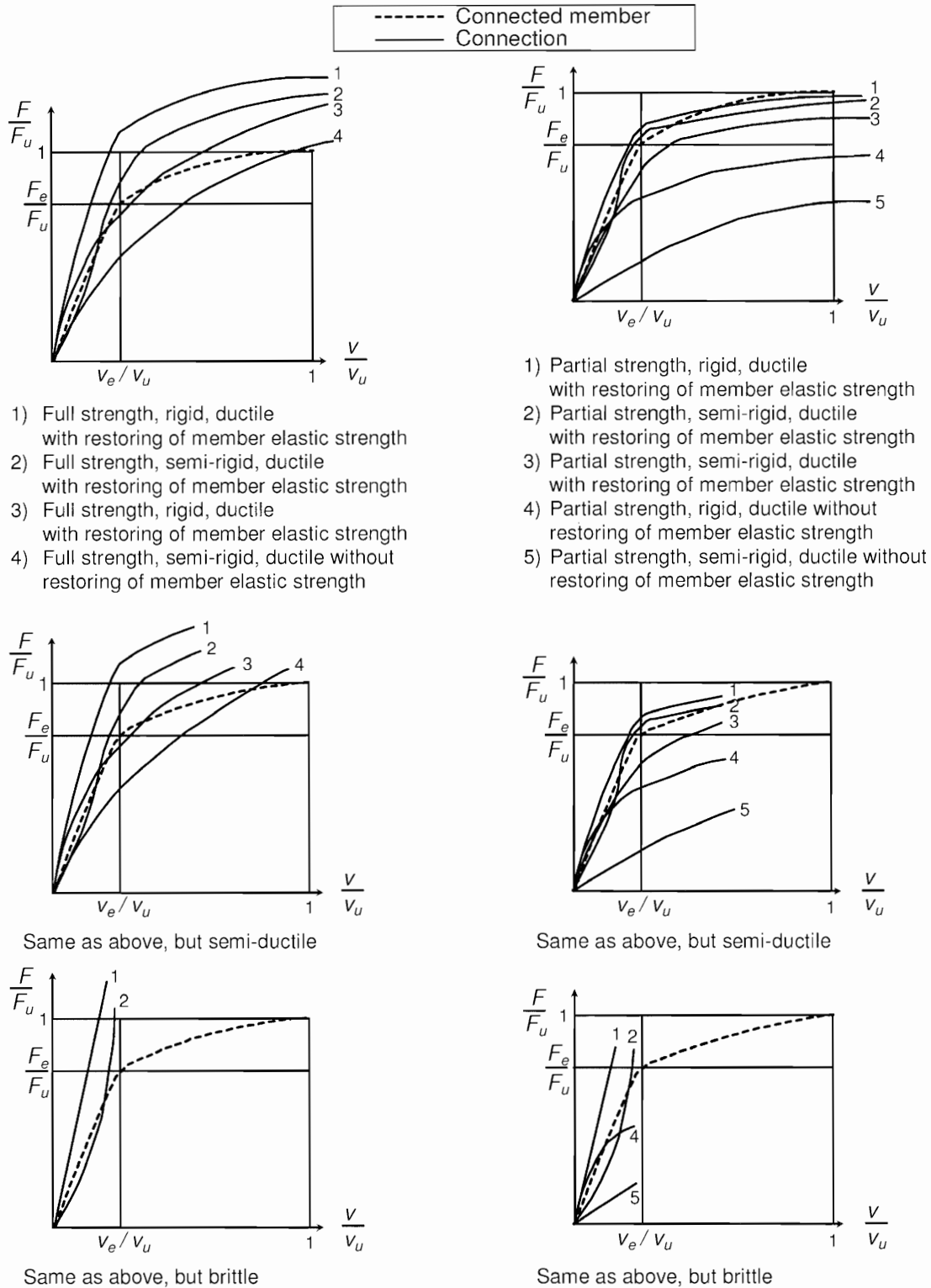

Figure L.3 - Main connection types

L.8.2 Nominally pinned connections

- (1) A nominally pinned connection should be designed in such a way to transmit the design axial and shear forces without developing significant moments which might adversely affect members of the structure.
- (2) Nominally pinned connections should be capable of transmitting the forces calculated in design and should be capable of accepting the resulting rotations.
- (3) The rotation capacity of a nominally pinned connection should be sufficient to enable all the necessary plastic hinges to develop under the design loads.

Table L.1 - General design requirements

Method of global analysis (see 5.2.1)	Type of connection which must be accounted for	Type of connection which may be ignored
ELASTIC	Semi-rigid connections (full or partial strength, ductile or non-ductile with or without restoring of member elastic strength) Partial strength connections (rigid or semi-rigid, ductile or non-ductile) without restoring of member elastic strength	Fully restoring connections Rigid connections (full or partial strength, ductile or non-ductile) with restoring of member elastic strength Partial strength connections (rigid, ductile or non-ductile) with restoring of member elastic strength
PLASTIC (rigid-plastic elastic-plastic inelastic-plastic)	Partial strength connections (rigid or semi-rigid ductile or non-ductile) without restoring of member elastic strength	Fully restoring connections Partial strength, ductile connections (rigid or semi-rigid) with restoring of member elastic strength Full strength connections
HARDENING (rigid-hardening elastic-hardening generically inelastic)	Partially restoring connections	Fully restoring connections

L.8.3 Built-in connections

(1) Built-in connections allow for the transmission of bending moment between connected members, together with axial and shear forces. They can be classified according to rigidity and strength as follows (see L.4 and L.5):

- rigid connections;
- semi-rigid connections;
- full strength connections;
- partial strength connections.

(2) A rigid connection should be designed in such a way that its deformation has a negligible influence on the distribution of internal forces and moments in the structure, nor on its overall deformation.

(3) The deformations of rigid connections should be such that they do not reduce the resistance of the structure by more than 5%.

(4) Semi-rigid connections should provide a predictable degree of interaction between members, based on the design moment-rotation characteristics of the joints.

(5) Rigid and semi-rigid connections should be capable of transmitting the forces and moments calculated in design.

(6) The rigidity of full-strength and partial-strength connections should be such that, under the design loads, the rotations at the necessary plastic hinges do not exceed their rotation capacities.

(7) The rotation capacity of a partial-strength connection which occurs at a plastic hinge location should be not less than that needed to enable all the necessary plastic hinges to develop under the design loads.

(8) The rotation capacity of a connection may be demonstrated by experimental evidence. Experimental demonstration is not required if using details which experience has proved have adequate properties in relation with the structural scheme.

Annex M [informative] - Adhesive bonded connections

M.1 General

- (1) Structural joints in aluminium may be made by bonding with adhesive.
- (2) Bonding needs an expert technique and should be used with great care.
- (3) The design guidance in this Annex M should only be used under the condition that:
 - the joint design is such that only shear forces have to be transmitted (see M.3.1);
 - appropriate adhesives are applied (see M.3.2);
 - the surface preparation procedures before bonding do meet the specifications as required by the application (see M.3.2(3)).
- (4) The use of adhesive for main structural joints should not be contemplated unless considerable testing has established its validity, including environmental testing and fatigue testing if relevant.
- (5) Adhesive jointing can be suitably applied for instance for plate/stiffener combinations and other secondary stressed conditions.
- (6) Loads should be carried over as large an area as possible. Increasing the width of joints usually increases the strength pro rata. Increasing the length is beneficial only for short overlaps. Longer overlaps result in more severe stress concentrations in particular at the ends of the laps.

M.2 Adhesives

- (1) The recommended families of adhesives for the assembly of aluminium structures are: single and two part modified epoxies, modified acrylics, one or two part polyurethane; anaerobic adhesives can also be used in the case of pin- and collar-assemblies.
- (2) On receipt of the adhesive, its freshness can be checked before curing by the following methods:
 - chemical analysis;
 - thermal analysis;
 - measurements of the viscosity and of the dry extract in conformity with existing ENs, prENs and ISO Standards related to adhesives.
- (3) The strength of an adhesive joint depends on the following factors:
 - a) the specific strength of the adhesive itself, that can be measured by standardised tests (see ISO 11003-2);
 - b) the alloy, and especially its proof stress if the yield stress of the metal is exceeded before the adhesive fails;
 - c) the surface pre-treatment: chemical conversion and anodising generally give better long term results than degreasing and mechanical abrasion; the use of primers is possible provided that one makes sure that the primer, the alloy and the adhesive are compatible by using bonding tests;
 - d) the environment and the ageing: the presence of water or damp atmosphere or aggressive environment can drastically lower the long term performance of the joint (especially in the case of poor surface pre-treatments);
 - e) the configuration of the joint and the related stress distribution, i.e. the ratio of the maximum shear stress τ_{\max} to the mean one ($\tau_{\max}/\tau_{\text{mean}}$) and the ratio of the maximum peel stress σ_{\max} to the mean shear one ($\sigma_{\max}/\tau_{\text{mean}}$), both maxima occurring at the end of the joint; the stress concentrations should be reduced as much as possible; they depend on the stiffness of the assembly (thickness and Young's modulus of the adherent) and on the overlap length of the joint.

(4) Knowledge of the specific strength of the adhesive is not sufficient to evaluate the strength of the joint, one must evaluate it by laboratory tests taking into account the whole assembly, i.e. the combinations of alloy/pre-treatment/adhesive, and the ageing or environment (see M.3 and 2.5).

(5) The strength obtained on specimens at the laboratory should be used as guidelines; one must check the joint performances in real conditions: the use of prototypes is recommended (see M.3).

M.3 Design of adhesive bonded joints

M.3.1 General

(1) In adhesive bonded joints, it should be aimed to transfer the loads by shear stresses; tensile stresses – in particular peeling or other forces tending to open the joint – should be avoided or should be transmitted by complementary structural means. Furthermore uniform distribution of stresses and sufficient deformation capacity to enable a ductile type of failure of the component are to be strived for.

Sufficient deformation capacity is arrived at in case the design strength of the joint is greater than the yield strength of the connected member.

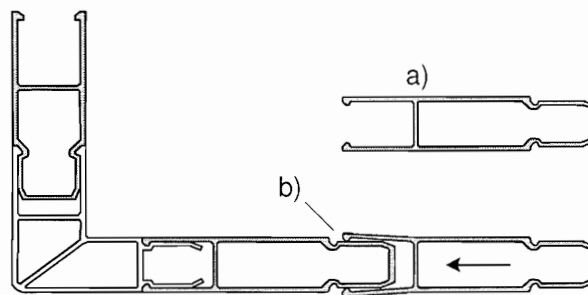

a) extruded profile, b) snap hook

Figure M.1 – Example of snap joints: tensile forces transmitted transverse to extrusion direction by snapping parts, but no shear transfer in longitudinal direction

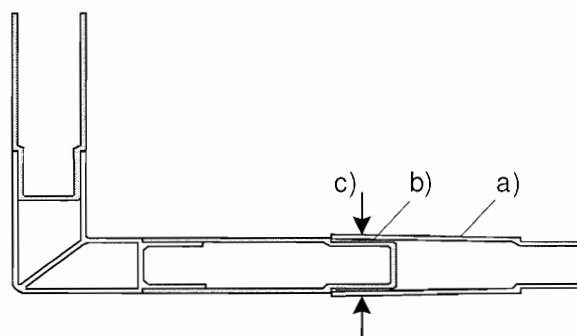

a) extruded profile, b) adhesive on outside surface, c) external pressure

Figure M.2 – Example of bonded extruded members: bonding allows transmitting tensile forces transverse by shear stresses and shear forces parallel to extrusion direction

M.3.2 Characteristic strength of adhesives

(1.) As far as the mechanical properties are concerned high strength adhesives should be used for structural applications (see Table M.1). However, also the toughness should be sufficient to overcome stress/strain concentrations and to enable a ductile type of failure.

(2) Pre-treatments of the surfaces to be bonded have to be chosen such that the bonded joint meets the design requirements during service life of the structure. See [A1](#) EN 1090-3 [A1](#).

(3) For the characteristic shear strength of adhesives $f_{v,adh}$ for structural applications the values of Table M.1 may be used.

Table M.1 - Characteristic shear strength values of adhesives

Adhesive types	$f_{v,adh}$ N/mm ²
1- component, heat cured, modified epoxide	35
2- components, cold cured, modified epoxide	25
2- components, cold cured, modified acrylic	20

(4) The adhesive types as mentioned in Table M.1 may be used in structural applications under the conditions as given earlier in M.3.1 and M.3.2 respectively. The values given in Table M.1 are based on results of extensive research. However, it is allowed to use higher shear strength values than the ones given in Table M.1, see M.4.

M.3.3 Design shear stress

(1) The design shear stress should be taken as

$$\tau \leq \frac{f_{v,adh}}{\gamma_{Ma}} \quad (M.1)$$

where:

- τ nominal shear stress in the adhesive layer;
- $f_{v,adh}$ characteristic shear strength value of adhesive, see M.3.2;
- γ_{Ma} partial safety factor for adhesive bonded joints, see 8.1.1. A1

NOTE The high value of γ_{Ma} in 8.1.1 has to be used since:

- the design of the joint is based on ultimate shear strength of the adhesive;
- the scatter in adhesive strength can be considerable;
- the experience with adhesive bonded joints is small;
- the strength decreases due to ageing.

M.4 Tests

(1) Higher characteristic shear strength values of adhesives than given in Table M.1 may be used if appropriate shear tests are carried out, see also ISO 11003.

Bibliography

- EN 1592-1 Aluminium and aluminium alloys - HF seam welded tubes - Part 1: Technical conditions for inspection and delivery
- EN 1592-2 Aluminium and aluminium alloys - HF seam welded tubes - Part 2: - Mechanical properties
- EN 1592-3 Aluminium and aluminium alloys - HF seam welded tubes - Part 3: - Tolerance on dimensions and shape of circular tubes
- EN 1592-4 Aluminium and aluminium alloys - HF seam welded tubes - Part 4: - Tolerance on dimensions and form for square, rectangular and shaped tubes